

HD-9 Four-Post Lift

Installation and Operation Manual

Manual P/N 5900123 — Manual Revision M — February 2020

Models:

- HD-9ST
- HD-9STX
- HD-9
- HD-9XL
- HD-9XW



HD-9ST shown.

Designed and engineered by BendPak Inc. in Southern California, USA. Made in China.

 **DANGER**

Read the *entire contents* of this manual *before* using this product. Failure to follow the instructions and safety precautions in this manual can result in serious injury or death. Make sure all other operators also read this manual. Keep the manual near the product for future reference. By proceeding with installation and operation, you agree that you fully understand the contents of this manual.

Manual. HD-9 Four-Post Lifts, *Installation and Operation Manual*, Manual P/N 5900123, Manual Revision M, Released February 2020.

Copyright. Copyright © 2020 by BendPak Inc. All rights reserved. You may make copies of this document if you agree that: you will give full attribution to BendPak Inc., you will not make changes to the content, you do not gain any rights to this content, and you will not use the copies for commercial purposes.

Trademarks. BendPak and the BendPak logo are registered trademarks of BendPak Inc. All other company, product, and service names are used for identification only. All trademarks and registered trademarks mentioned in this manual are the property of their respective owners.

Limitations. Every effort has been made to make sure complete and accurate instructions are included in this manual. However, product updates, revisions, and/or changes may have occurred since this manual was published. BendPak reserves the right to change any information in this manual without incurring any obligation for equipment previously or subsequently sold. BendPak is not responsible for typographical errors in this manual. You can always find the latest version of the **manual for your product on the BendPak website**.

Warranty. The BendPak warranty is more than a commitment to you: it is also a commitment to the value of your new product. Contact your nearest BendPak dealer or visit www.bendpak.com/support/warranty for full warranty details. Go to bendpak.com/support/register-your-product/ and fill out the online form to register your product (be sure to click **Submit**).

Safety. Your product was designed and manufactured with safety in mind. However, your safety also depends on proper training and thoughtful operation. Do not install, operate, maintain, or repair the unit without reading and understanding this manual and the labels on the unit; **do not use your Lift unless you can do so safely!**

Owner Responsibility. In order to maintain your product properly and to ensure everyone's safety, it is the responsibility of the product owner to read and follow these instructions:

- Follow all installation, operation, and maintenance instructions.
- Make sure product installation conforms to all applicable local, state, and federal codes, rules, and regulations, such as state and federal OSHA regulations and electrical codes.
- Read and follow all safety instructions; keep them readily available for operators.
- Make sure all operators are properly trained, know how to safely operate the unit, and are properly supervised.
- Do not operate the product until you are certain that all parts are in place and operating correctly.
- Carefully inspect the product on a regular basis and perform all maintenance as specified.
- Service and maintain the unit with approved replacement parts only.
- Keep instructions permanently with the product and make sure all labels are clean and visible.
- **Only use the Lift if it can be used safely!**

Unit Information. Enter the Model Number, Serial Number, and the Date of Manufacture from the label on your unit. This information is required for part or warranty issues.

Model: _____

Serial: _____

Date of Manufacture: _____

BP BendPak		Santa Paula, CA USA www.bendpak.com	
MODEL NUMBER			
DESCRIPTION			
LIFT CAPACITY		DATE OF MFG.	
ROLLING JACK MAX CAP.		MAX PSI / BAR	
VOLTAGE		SERIAL NUMBER	
<input type="checkbox"/> 110-240V, 50-60 Hz, 1 Ph		UPC	
<input type="checkbox"/> 208-240V, 50-60 Hz, 1 Ph			
<input type="checkbox"/> 380-415V, 50-60 Hz, 3 Ph			
<input type="checkbox"/> 208-440V, 50-60 Hz, 3 Ph			
DANGER! Disconnect Power Before Servicing		WARRANTY VOID IF DATA PLATE IS REMOVED PN 5905953	

Table of Contents

Introduction	3	Operation	68
Shipping Information	4	Maintenance	71
Safety Considerations	4	Troubleshooting	73
Components	6	Wiring Diagrams	74
Specifications	8	Labels	76
FAQs	11	Parts Drawings	79
Installation Checklist	12	ALI Store	91
Installation	13		

Introduction

This manual describes the following BendPak Four-Post Lifts:

- **HD-9ST**. Four-Post Lift with an overall width of 100.25" (8.4 feet), raising Vehicles up to 9,000 lbs (4,082 kg). ALI certified.
- **HD-9STX**. Has the same overall width as the HD-9ST but with **higher rise** and **extended length**. ALI certified.
- **HD-9**. Four-Post Lift with an overall width of 110.25" (9.2 feet), raising Vehicles up to 9,000 lbs (4,082 kg). ALI certified.
- **HD-9XL**. Has the same overall width as the HD-9, but with **extended length**. ALI certified.
- **HD-9XW**. Has the same overall width as the HD-9, but with **higher rise** and **extended length**. ALI certified.

This manual is mandatory reading for all users of the HD-9 Series, including anyone who installs, uses, maintains, repairs, or wants to know more about them.

 **DANGER** Use care when installing, operating, maintaining, or repairing this equipment; failure to do so could result in property damage, product damage, injury, or (in very rare cases) death. Make sure only authorized personnel operate this equipment. All repairs must be performed by an authorized technician. Do not make modifications to the unit; this voids the warranty and increases the chances of injury or property damage. Make sure to read and follow the instructions in this manual and on the labels on the unit.

Keep this manual on or near the equipment so that anyone who uses or services it can read it. If you are having issues, refer to the **Troubleshooting** section of this manual for assistance.

Technical support and service is available from your dealer, on the Web at bendpak.com/support, by email at techsupport@bendpak.com, or by phone at **(800) 253-2363**, extension 196. You may also contact BendPak for parts replacement information at **(800) 253-2363**, extension 191; please have the model and serial number of your unit available.

Shipping Information

Your equipment was carefully checked before shipping. Nevertheless, you should thoroughly inspect the shipment **before** you sign to acknowledge that you received it.

When you sign a bill of lading, it tells the carrier that the items on the invoice were received in good condition. **To protect yourself, do not sign until after you have inspected the shipment.** If any of the items listed on the bill of lading are missing or are damaged, do not accept the shipment until the carrier makes a notation on the bill of lading that lists the missing and/or damaged goods.

If you discover missing or damaged goods **after** you receive the shipment and have signed the bill of lading, notify the carrier at once and request the carrier to make an inspection. If the carrier will not make an inspection, prepare a signed statement to the effect that you have notified the carrier (on a specific date) and that the carrier has failed to comply with your request.

It is difficult to collect for loss or damage after you have given the carrier a signed bill of lading. If this happens to you, file a claim with the carrier promptly. Support your claim with copies of the bill of lading, freight bill, invoice, and photographs, if available. **Our willingness to assist in helping you process your claim does not make us responsible for collection of claims or replacement of lost or damaged materials.**

Safety Considerations

Read this entire manual carefully before installing or using the product. Do not install or operate the product until you are familiar with all operating instructions and warnings. Do not allow anyone else to operate it until they are familiar with all operating instructions and warnings. Keep this manual on or near the product for future reference.

Read and follow the warnings and instructions on the labels on the product. Contact BendPak at **(800) 253-2363** or techsupport@bendpak.com if you need replacement labels or a replacement manual.

Safety Information





The following safety information applies to the HD-9 Four-Post Lifts:

- BendPak recommends referring to the ANSI/ALI ALIS Standard (R2015) *Safety Requirements for Installation and Service* for more information about safely installing, using, and servicing your Lift.
- The product may only be operated by authorized, trained persons.
- You **must** wear OSHA-approved (publication 3151) personal protective equipment at all times when installing, using, maintaining, or repairing the Lift: leather gloves, steel-toed work boots, eye protection, back belts, and hearing protection are **mandatory**.
- **Never** exceed the rated capacity of the Lift.
- When the Lift is in use, keep all body parts well away from it.
- Do not make any modifications to the Lift; this voids the warranty and increases the chances of injury or property damage.
- Make sure all operators read and understand this *Installation and Operation Manual*. Keep the manual near the Lift at all times.
- Make an inspection of the Lift **before** using it. Check for damaged, worn, or missing parts. Do not use it if you find any of these issues. Instead, take it out of service, then contact an authorized repair facility, your dealer, or BendPak at **(800) 253-2363** or techsupport@bendpak.com.

-
- BendPak recommends making a **thorough** inspection of the product at least once a year. Replace any damaged or severely worn parts, decals, or warning labels.

Symbols

Following are the symbols used in this manual:

-  **DANGER** Calls attention to an immediate hazard that **will** result in death or severe injury.
-  **WARNING** Calls attention to a hazard or unsafe practice that **could** result in death or severe personal injury.
-  **CAUTION** Calls attention to a hazard or unsafe practice that could result in minor personal injury, product damage, or property damage.
- NOTICE** Calls attention to a situation that, if not avoided, could result in product or property damage.
-  **Tip** Calls attention to information that can help you use your product better.

Liability Information

BendPak Inc. assumes **no** liability for damages resulting from:

- Use of the equipment for purposes other than those described in this manual.
- Modifications to the equipment without prior, written permission from BendPak.
- Injury or death caused by modifying, disabling, overriding or removing safety features.
- Damage to the equipment from external influences.
- Incorrect operation of the equipment.

Electrical Information

-  **DANGER** All wiring **must** be performed by a licensed, certified Electrician. Do not perform any maintenance until main electrical power has been disconnected from the Lift and cannot be re-energized until all procedures are complete.

Important electrical information:

- Improper electrical installation can damage the Power Unit motor, which is not covered by the warranty.
- The Lift uses electrical energy; if your organization has Lockout/Tagout policies, make sure to implement them after connecting to a power source.
- Use a separate circuit breaker for each Power Unit.
- Protect each circuit with a time delay fuse or circuit breaker:
 - For a 208 to 230 VAC, single phase circuit, use a 25 amp fuse.
 - For a 208 to 230 VAC, three phase circuit, use a 20 amp fuse.
 - For a 380 to 440 VAC, three phase circuit, use a 15 amp fuse.

Components

The main components of your Lift include:

- **Power Post.** The Post that holds the Power Unit. ***The Power Post can be in either of two locations.*** You can tell the Power Post from the other Posts because it has two Mounting Brackets on it. Mount the Power Unit on one of the two Mounting Brackets.
- **The other three Posts.** These Posts are interchangeable.
- **Power Unit.** An electric/hydraulic unit that connects to an electric power source and then provides Hydraulic Fluid to the Hydraulic Cylinder that raises and lowers the Runways.
- **Powerside Runway.** On the same side as the Power Post. The Powerside Runway has the Hydraulic Cylinder and the Lifting Cables under them. The Powerside Runway ***must*** go next to the Power Post.
- **Offside Runways.** The other Runway. It does not have a Hydraulic Cylinder or Lifting Cables under.
- **Utility Rails.** Hold the optional Rolling Jacks. Utility Rails ***must*** go on the inside of the Lift.
- **Crosstubes.** Go at each end of the Lift. The Crosstubes are hollow; the Lifting Cables that raise and lower the Runways are routed through the Crosstubes. The Crosstubes are *not* interchangeable: Each Crosstube has an opening (called a ‘Window’) that faces the inside of the Lift. ***Make sure to install the Lift so that the Windows open to the inside of the Lift only.***
- **Drive-up Ramps.** One for each Runway. Use them to drive onto and off of the Runways.
- **Tire Stops.** Located at the Front of the Lift, Tire Stops prevent the Vehicle’s Front Tires from going any further forward. Additionally, we strongly recommend chocking the Vehicle’s Rear Tires.
- **Safety Locks.** Once engaged, they hold the Runways in position, even if the power goes out or there is a leak in the Hydraulic Hoses. Your Lift has a column of Safety Locks in each post, spaced every four inches. This lets you lock the Runways at just the right height for what you want to do. This Lift also has a backup Slack Safety system; refer to **About Safety Locks** for more information. ***Only leave the Runways on the ground or engaged on a Safety Lock.***
- **Pushbutton Air Valve.** Includes a Pushbutton that moves the Safety Locks away from the Ladder so that they do not engage as you lower the Runways. Used only to lower the Runways. Usually located next to the Power Post.
- **Ladders.** Pieces of steel that gets installed at the back of each Post; these are part of the Safety Lock system.

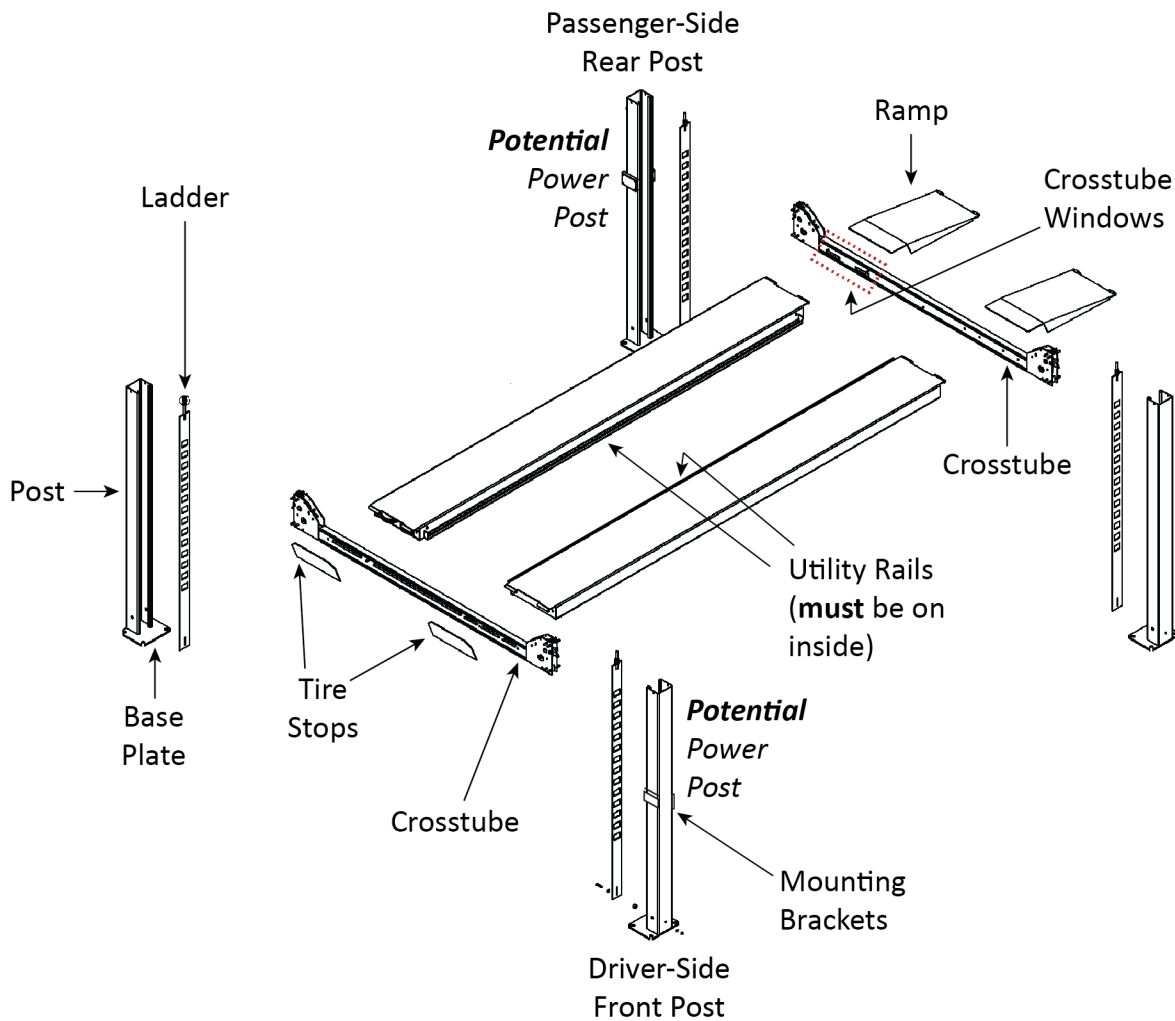

Drawing shows the two possible Power Post locations; only one Post has the Brackets for mounting the Power Unit. Not all components are shown.

Optional Accessories

There are additional products you can use with your Lift:

- **Aluminum Drive-up Ramps.** The Aluminum Drive-up Ramps are a low-profile alternative to the standard Drive-up Ramps that come with your Lift. See the [Aluminum Approach Ramps page on the BendPak website](#) for more information.
- **Aluminum Platforms.** Aluminum Platforms fill in the open space between the Lift's two Runways, preventing liquids from dripping on the floor or onto a Vehicle below the Runways. See the [Aluminum Platforms page on the BendPak website](#) for more information.
- **Caster Kit.** The Caster Kit allows you to pick up and move your Lift without needing to disassemble it. See the [Caster Kit page on the BendPak website](#) for more information.
- **Plastic Drip Trays.** Plastic Drip Trays prevent liquids from falling onto your work area or Vehicle. See the [Plastic Drip Trays page on the BendPak website](#) for more information.
- **Rolling Bridge Jack.** A Rolling Bridge Jack raises the wheels of a Vehicle off the Runways of a Lift, making it much easier to perform service such as brake jobs and suspension work while the Vehicle is still on the Lift. See the [RBJ4500 Rolling Bridge Jack page on the BendPak website](#) for more information.

Specifications

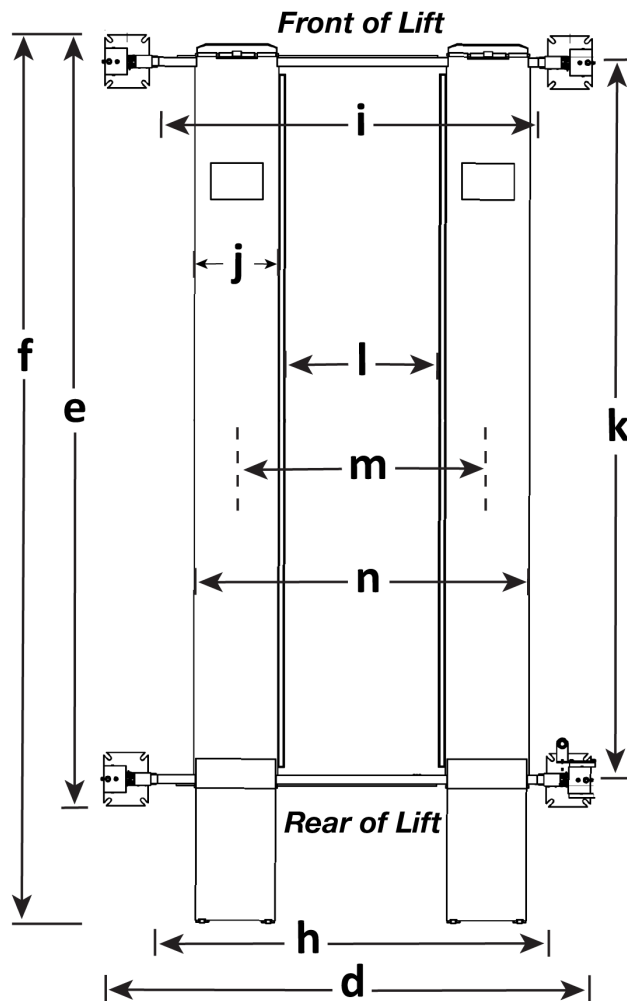
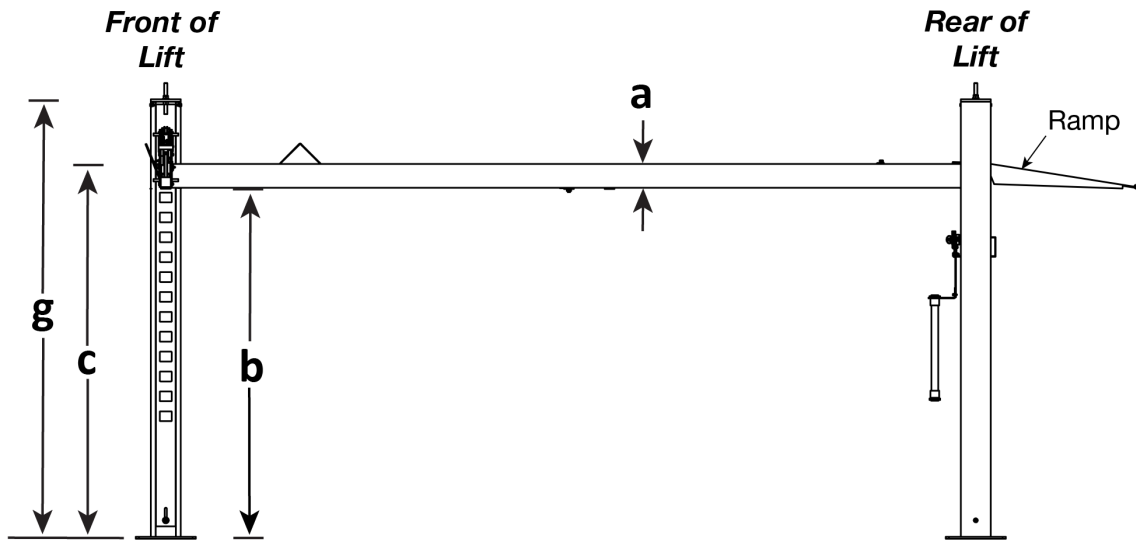

Model	HD-9ST	HD-9STX
Lifting Capacity	9,000 lbs / 4,082 kg	
Max capacity at Front Axle	4,500 lbs / 2,041 kg	
Max capacity at Rear Axle	4,500 lbs / 2,041 kg	
a Min. runway height	5" / 125 mm	
b Maximum rise	70" (5.10 feet) / 1,778 mm	82" (6.10 feet) / 2,083 mm
c Maximum lifting height	75" (6.3 feet) / 1,903 mm	87" (7.3 feet) / 2,208 mm
d Overall width	100.25" (8.4 feet) / 2,546 mm	
e Outside length	174" (14.6 feet) / 4,420 mm	198" (16.6 feet) / 5,029 mm
f Overall length	200.5" (16.9 feet) / 5,094 mm	224.5" (18.9 feet) / 5,704 mm
g Height of post	88" (7.4 feet) / 2,235 mm	100" (8.4 feet) / 2,540 mm
h Distance between posts	90" (7.6 feet) / 2,292 mm	
i Drive-thru clearance	76.5" (6.5 feet) / 1,943 mm	
j Runway width	19" / 482 mm	
k Runway length	164.5" (13.9 feet) / 4,178 mm	188.5" (15.9 feet) / 4,788 mm
l Width between runways	38" (3.2 feet) / 963 mm	
m Runway centerline	56.5" (4.9 feet) / 1,435 mm	
n Outside edge of runways	75.5" (6.4 feet) / 1,918 mm	
Min. wheelbase @ rated capacity ¹	115" (9.7 feet) / 2,921 mm	135" (11.3 feet) / 3,429 mm
Min. wheelbase @ 75 capacity ¹	100" (8.4 feet) / 2,540 mm	115" (9.7 feet) / 2,921 mm
Min. wheelbase @ 50 capacity ¹	85" (7.1 feet) / 2,159 mm	95" (7.11 feet) / 2,413 mm
Min. wheelbase @ 25 capacity ¹	70" (5.10 feet) / 1,778 mm	80" (6.8 feet) / 2,032 mm
Safety Lock positions	14, spaced every 4" / 102 mm	17, spaced every 4" / 102 mm
Lifting time	45 – 50 seconds	
Motor	60 Hz, 1 Ph (<i>special voltages available upon request</i>)	

¹ The Lift supports less weight than its rated capacity if the Vehicle's wheelbase is shorter; this is because the wheels are closer to the middle of the Runways, where there is less strength. For example, the maximum weight allowed on the Lift for a Vehicle with a wheelbase of 85" is 50 percent of the Lift's rated capacity (or 4,500 lbs when the rated capacity is 9,000 lbs).

Specifications subject to change without notice.

Model	HD-9	HD-9XL	HD-9XW
Lifting capacity	9,000 lbs / 4,082 kg		
Max capacity at Front Axle	4,500 lbs / 2,041 kg		
Max capacity at Rear Axle	4,500 lbs / 2,041 kg		
a Min. runway height	4.5" / 114 mm		
b Maximum rise	70" (5.10 feet) / 1,778 mm	82" (6.10 feet) / 2,083 mm	
c Maximum lifting height	75" (6.3 feet) / 1,903 mm	87" (7.3 feet) / 2,208 mm	
d Overall width	110.25" (9.2 feet) / 2,800 mm		
e Outside length	174" (14.6 feet) / 4,420 mm	198" (16.6 feet) / 5,029 mm	
f Overall length	200" (16.8 feet) / 5,080 mm	224" (18.8 feet) / 5,690 mm	
g Height of post	88" (7.4 feet) / 2,235 mm	100" (8.4 feet) / 2,540 mm	
h Distance between posts	100.25" (8.4 feet) / 2,555 mm		
i Drive-thru clearance	86.5" (7.3 feet) / 2,197 mm		
j Runway width	19" / 482 mm		
k Runway length	164.5" (13.9 feet) / 4,178 mm	188.5" (15.9 feet) / 4,788 mm	
l Width between runways	38" / 963 mm <i>or</i> 44.25" / 1,127 mm		
m Runway centerline	56.5" – 63.25" / 1,435 – 1,610 mm		
n Outside edge of runways	75.5" – 82.25" / 1,918 – 2,092 mm		
Min. wheelbase @ rated capacity ¹	115" (9.7 feet) / 2,921 mm	135" (11.3 feet) / 3,429mm	
Min. wheelbase @ 75 capacity ¹	100" (8.4 feet) / 2,540 mm	115" (9.7 feet) / 2,921 mm	
Min. wheelbase @ 50 capacity ¹	85" (7.1 feet) / 2,159 mm	95" (7.11 feet) / 2,413 mm	
Min. wheelbase @ 25 capacity ¹	70" (5.10 feet) / 1,778 mm	80" (6.8 feet) / 2,032 mm	
Locking positions	14, spaced every 4" / 102 mm	14; spaced every 4" / 102 mm	17; spaced every 4" / 102 mm
Motor	220 VAC, 60 Hz, 1 Ph (<i>special voltages available upon request</i>)		

¹ The Lift supports less weight than its rated capacity if the Vehicle's wheelbase is shorter; this is because the wheels are closer to the middle of the Runways, where there is less strength. For example, the maximum weight allowed on the Lift for a Vehicle with a wheelbase of 85" is 50 percent of the Lift's rated capacity (or 4,500 lbs when the rated capacity is 9,000 lbs).

Specifications subject to change without notice.

Frequently Asked Questions

Question: What kinds of Vehicles can I put on my Lift?

Answer: Cars, trucks, SUVs; anything that fits on the Runways, up to 9,000 lbs (4,082 kg).

Q: Can any of the four Posts be the 'Power Post'?

A: No; the only two possible locations for the Power Post are either the *Front Driver-Side* or the *Rear Passenger-Side*. This will be explained later.

Q: How can my Lift fit both narrow and wide Vehicles on the Runways?

A: The Offside Runway (the Runway without the Hydraulic Cylinder or Lifting Cables underneath) can be easily switched between the narrow and wide settings. You would need to unbolt the Offside Runway on both ends, slide it over to the other position, and then bolt it into position. ***The adjustable Offside Runway does not apply to the HD-9ST or HD-9STX models.***

Q: Does the Lift have to be anchored in place?

A: Yes, BendPak **strongly** recommends that you anchor the Lift; it may be less stable if you do not anchor the Bases, and you could possibly void ALI certification. If you plan to use the optional Rolling Bridge Jack, the Lift **must** be anchored.

Q: How high does the ceiling have to be?

A: It depends on the height of the Vehicles you are putting on the Runways and how high you raise the Runways. If you are going to put a tall Vehicle on the Lift and raise it all the way up, you should check to make sure there is enough room.

Q: Does it matter if I drive my Vehicles in front first or back them in?

A: We strongly recommend driving your Vehicle in front first, because that makes it easier to center the wheels on the Runways. Also, remember to put the front wheels up against the Tire Stops and chock the rear wheels.

Q: Will the Lifting Cables really hold my Vehicles?

A: Yes. Your Lift has 4/10 inch thick, aircraft-quality wire rope that runs through oversized Sheaves, reducing friction on them and extending their life with minimal maintenance.

Q: How many Safety Locks does my Lift have?

A: Depending on the Lift model you have, your Lift has either 14 or 17 Safety Locks for you to use. See **Specifications** for more information about your Lift model.

Q: How long can I leave a Vehicle on a raised Runway?

A: As long as you want, ***if it is on a Safety Lock***. Once the Lift is engaged on a Safety Lock, gravity holds it in position, so a loss of power does not impact it; it is going to stay where you left it. ***Always leave the Runways either fully lowered or engaged on a Safety Lock.***

Q: Can I install my Lift outside?

A: Your Lift is approved for indoor installation and use only. Outdoor installation is prohibited.

Q: How many Rolling Bridge Jacks can I use on my Four Post Lift?

A: Two. **Never** place the Rolling Bridge Jack towards the middle of the Runways, they **must** go at the Front or Rear of the Lift.

Installation Checklist

Following are the steps needed to install your Lift. Perform them in the order shown.

- 1. Review the safety rules.
- 2. Make sure you have the necessary tools.
- 3. Plan for Electrical work.
- 4. Select the installation location.
- 5. Check the Clearances.
- 6. Decide the Lift Orientation.
- 7. Unload and unpack the Lift components.
- 8. Create Chalk Line Guides.
- 9. Move the Posts into position.
- 10. Install the Crosstubes.
- 11. About Safety Locks.
- 12. Install the Ladders and Top Caps.
- 13. Raise the Crosstubes.
- 14. Secure the Ladders.
- 15. Removing the Sheaves.
- 16. Install the Runways.
- 17. Route the Lifting Cables.
- 18. Working with Compression Fittings and Tubing.
- 19. Install the Air Line.
- 20. Install the Return Line.
- 21. About Hydraulic Contamination.
- 22. Install the Hydraulic Hose.
- 23. Install the Power Unit.
- 24. Install the Flex Tube Bracket Plate and Angle Plate.
- 25. Install the Flex Tube.
- 26. Install the Pushbutton Air Valve and connect the Air Lines.
- 27. Connect the Return Line.
- 28. Connect the Hydraulic Hose.
- 29. Contact the Electrician.
- 30. Connect to a power source (***Electrician required***).
- 31. Install the Power Disconnect Switch and Thermal Disconnect Switch (***Electrician required***).
- 32. About Effective Embedment.
- 33. Anchor the Posts.
- 34. Perform final leveling.
- 35. Install the Accessories.
- 36. Lubricate the Lift.
- 37. Test the Lift.
- 38. Review the final checklist.
- 39. Outdoor usage.

Installation

The installation process takes multiple steps. Perform them in the order listed.

Read the entire Installation section before beginning the install, this gives you a better understanding of the process as a whole.

 **WARNING** **Only use the factory-supplied parts that came with your Lift.** If you use parts from a different source, you void your warranty and compromise the safety of everyone who installs or uses the Lift. If you are missing parts, visit bendpak.com/support or call **(800) 253-2363**, extension 191.

Being Safe

While installing this equipment, your safety depends on proper training and thoughtful operation.

 **WARNING** Do not install this equipment unless you have automotive Lift installation training. Always use proper lifting tools, such as a Forklift or Shop Crane, to move heavy components. Do not install this equipment without reading and understanding this manual and the safety labels on the unit.

Only fully trained personnel should be involved in installing this equipment. Pay attention at all times. Use appropriate tools and lifting equipment. Stay clear of moving parts.

BendPak recommends referring to the current version of the ANSI/ALI ALIS Standard *Safety Requirements for Installation and Service* for more information about safely installing, using, and servicing your Lift.

 **WARNING** You **must** wear OSHA-approved (publication 3151) personal protective equipment at all times when installing, using, maintaining, or repairing the Lift: leather gloves, steel-toed work boots, eye protection, back belts, and hearing protection are **mandatory**.

Using Tools

You may need some or all of the following tools:

- Rotary hammer drill or similar
- ¾ inch carbide bit (conforming to ANSI B212.15)
- Hammer, crow bar, and two sawhorses
- Four-foot level and 12-foot ladder
- Open-end wrench set, SAE and metric
- Socket and ratchet set, SAE and metric
- Hex key wrench set
- Medium crescent wrench, torque wrench, pipe wrench
- Chalk line
- Medium-sized flat screwdriver and needle-nose pliers
- Tape measure (25 feet or above)
- Forklift, Shop Crane, or heavy-duty rolling dolly

Planning for Electrical Work

You will need to have a licensed, certified Electrician available at some point in the installation.

⚠ DANGER All wiring *must* be performed by a licensed, certified Electrician.

Notify your Electrician in advance so that they come prepared with an appropriate Power Cord with a Plug for connecting to the power source, a Power Disconnect Switch, and a Thermal Disconnect Switch. Refer to **Contacting the Electrician** for more information.

Your Electrician needs to:

- **Connect the Power Unit to an electric power source.** An electric power source is required. The Power Unit comes with a pigtail for wiring to a power source. Have your Electrician remove the pigtail and wire from inside the Electrical Box on the Power Unit to a Power Cord and Plug or have them wire it directly into the electrical system at the Lift location.

Note: Installing the Power Unit and connecting the Power Unit to the power source are *separate* procedures and are completed at different times in the installation process. You do not need an Electrician to install the Power Unit, but an Electrician is **required** to connect the Power Unit to the power source.

- **Install a Power Disconnect Switch.** Ensures you can quickly and completely interrupt electrical power to the Lift in the event of an electrical circuit fault, emergency situation, or when equipment is undergoing service or maintenance. Put it within sight and reach of the Lift operator.
- **Install a Thermal Disconnect Switch.** Ensures the equipment shuts down in the event of an overload or an overheated motor.

Note: None of these components are included with the Lift.

Selecting a Location

When selecting the location for your Lift, consider:

- **Architectural plans.** Consult the architectural plans for your desired installation location. Make sure there are no issues between what you want to do and what the plans show.
- **Available space.** Make sure there is enough space for the Lift: front, back, sides, and above. Refer to **Specifications** for measurements.
- **Overhead Clearance.** Check for overhead obstructions such as building supports, heaters, electrical lines, low ceilings, hanging lights, and so on. Use the maximum lifting height of your Lift model plus the height of the tallest Vehicle you plan on raising to determine how much height you will need at the Lift location.
- **Power.** You need an appropriate power source for the Power Unit.
- **Outdoor installations.** Your Lift is approved for indoor installation and use **only**.
- **Floor.** Only install the Lift on a flat, concrete floor; do not install on asphalt or any other surface. The surface must be level; do not install if the surface has more than three degrees of slope.

 **WARNING** Installing your Lift on a surface with more than three degrees of slope could lead to injury or even death; only install the Lift on a level floor. If your floor is not level, consider making the floor level or using a different location.

- **Shimming.** If your concrete floor is not completely level, you can use Shims under the bases of the Posts, as needed, to level the Lift. To estimate your Shim requirements, use a transit level and targets to check for flatness. Use the provided Shims as necessary.

NOTICE Do not shim a Post more than half an inch using the provided Shims and Anchor Bolts. A maximum shim of 2 inches is possible by ordering optional Shim Plates. Contact BendPak at **(800) 253-2363**, extension 191 to order.

- **Concrete specifications.** Do not install the Lift within 6 inches of cracked or defective concrete. Make sure the concrete is at least 4.25 inches thick, 3,000 PSI, and cured for a minimum of 28 days.

 **CAUTION** BendPak lifts are supplied with installation instructions and Concrete anchors that meet the criteria set by the current version of the American National Standard “Automotive Lifts – Safety Requirements for Construction, Testing, and Validation”, ANSI/ALI ALCTV. You are responsible for any special regional structural and/or seismic anchoring requirements specified by any other agencies and/or codes such as the Uniform Building Code (UBC) and/or International Building Code (IBC).

Be sure to check your floor for the possibility of it being a **post-tension slab**. In this case, you must contact the building architect **before** drilling. Using ground penetrating radar may help you find the tensioned steel.

 **WARNING** Cutting through a tensioned Cable can result in injury or death. Do not drill into a post-tension slab unless the building architect confirms you are not going to hit tensioned steel or you have located it using ground penetrating radar. ***If colored sheath comes up during drilling, stop drilling immediately.***

- **Multi-Lift installations.** In a Multi-Lift layout, there must be a *minimum* spacing of 5 inches from the edge of the Baseplates to the edge of the Baseplates on the next Lift.

 **WARNING** Installing a Lift closer than 5 inches from the next Lift compromises the holding strength of the Anchor Bolts, putting anyone near the Lifts in danger.

- Non-Slip Rubber Pads.** If you do not plan to anchor the Lift (and want to use the optional Caster Kit), you could go to your local hardware store and get non-slip Rubber Pads and size them to fit the bottom of the Base Plates; the Pads will protect against scratches on special flooring if the Lift accidentally shifts as a result of not anchoring the Lift. Use the Caster Kit to raise the Lift and then put the Pads into place.

Checking Clearances

Out of the concern of safety, a certain amount of clear space around the Lift is **required**.

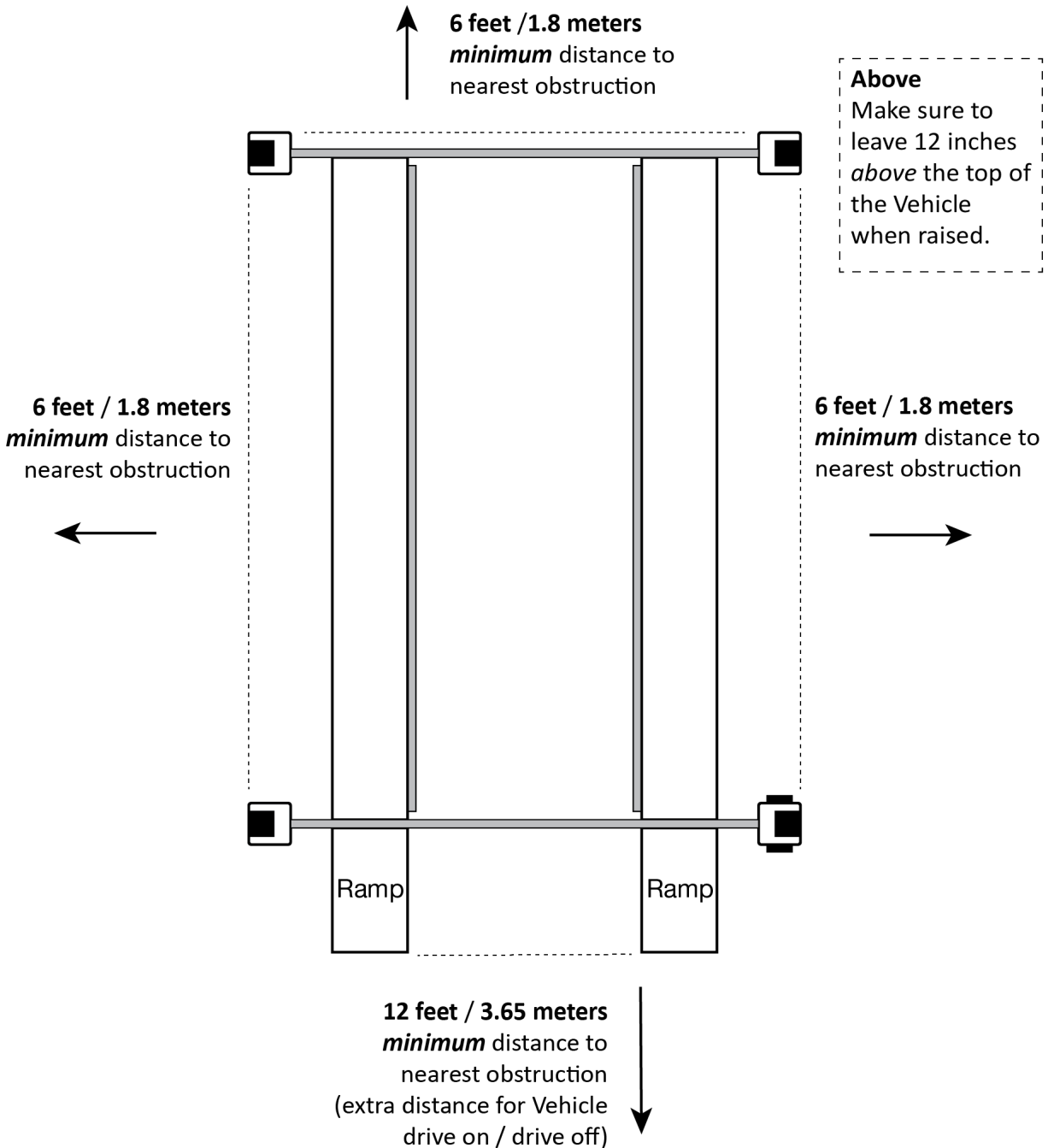

Deciding the Lift Orientation

Before going any further, decide how you want to orient your Lift. This decision affects where you will place your Power Post and also the positioning of the Runways, which are **not** interchangeable.

One Runway has the Hydraulic Cylinder underneath it and is the starting point for the Lifting Cables. The other Runway, called the Offside Runway, does not have anything underneath it. The Runway with the Hydraulic Cylinder is the Powerside Runway and **must** be installed next to the Power Post.

You can choose to position your Power Post at either the **Front Driver-Side** or the **Rear Passenger-Side**.

The drawings in this manual show the Power Post at the **Rear Passenger-Side**, but that does not mean you have to. In many cases, the main factor is the location of the power source; many customers prefer to place their Power Post (which holds the Power Unit) near the power source. If power is not an issue, choose the option below that best fits your setup.

Important: Installers, you need to have the Lift owner make this decision no later than when moving the Posts into position.

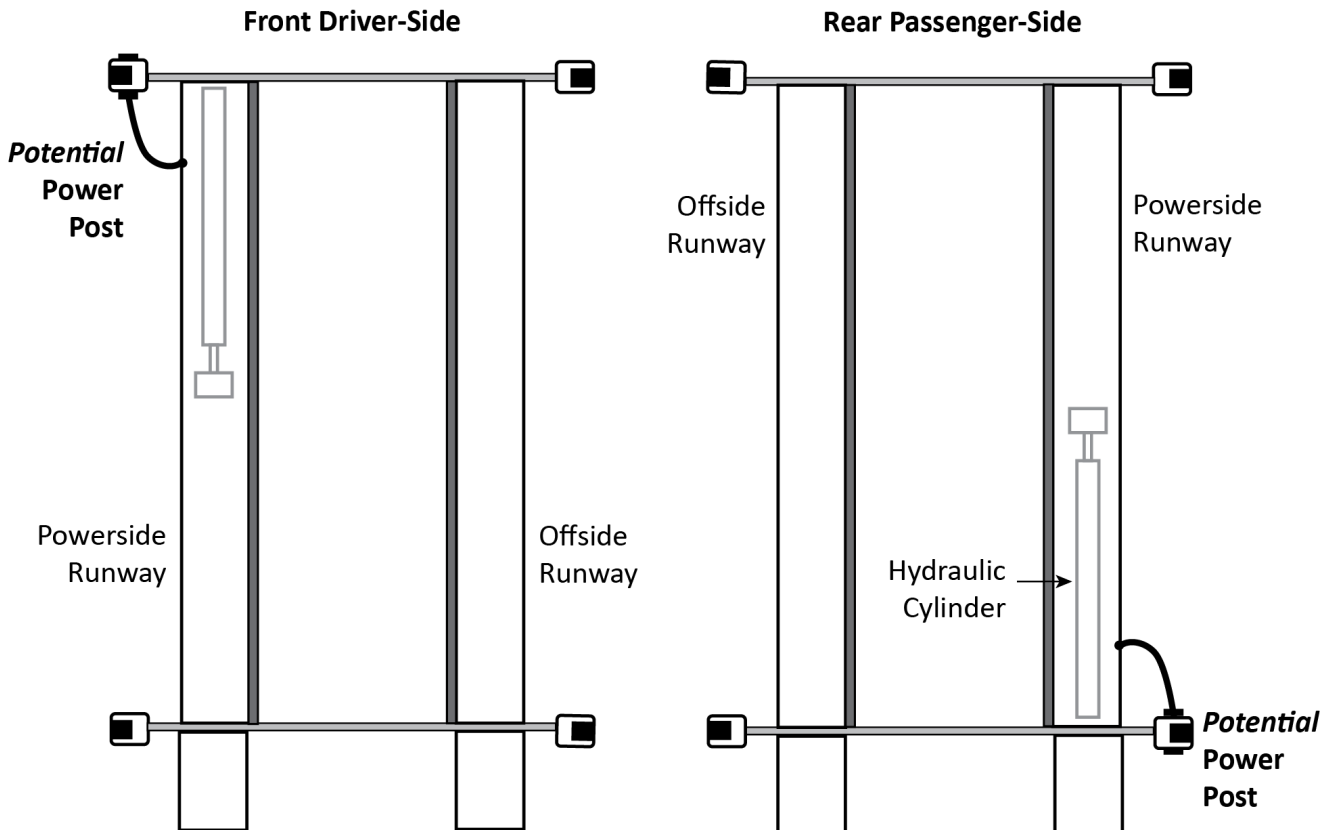

Hydraulic Cylinder is underneath the Runway. Drive-up Ramps are not affected by Power Post location. Not to scale. Not all components shown.

Creating Chalk Line Guides

Create the Chalk Line Guides so that the outside edges of all four Posts fit into the four corners created by the Chalk Line Guides.

See [Specifications](#) to determine the **Overall Width** and **Outside Length** values for your Lift.

Note: Do *not* use the **Overall Length** value; this includes the Ramps, which are not taken into consideration for creating Chalk Line Guides.

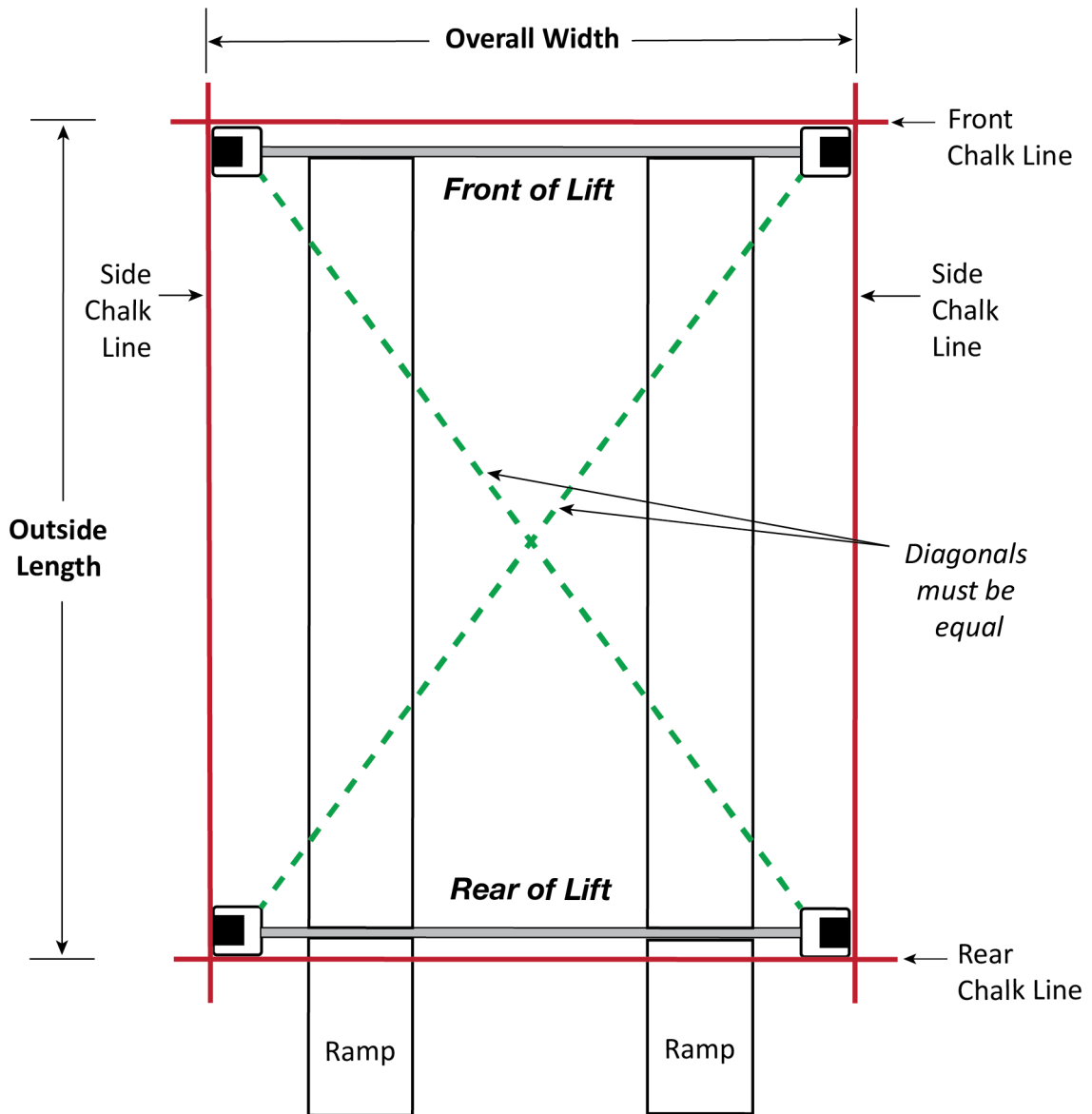

Top View. Not drawn to scale. Not all components shown.

To create Chalk Line Guides:

1. Create the Front Chalk Line where you want the Front of the Lift.

The Front of the Lift is the end opposite the Drive-up Ramps.

Make the Front Chalk Line *longer* (about 12 inches) than the **Overall Width** setting.

2. Create the two Side Chalk Lines at 90° angles to the Front Chalk Line and parallel to each other. Make the Side Chalk Lines longer (about 12 inches on each end) than the **Outside Length** setting.

The Side Chalk Lines **must** be parallel to each other.

Measure to verify that they are parallel.

3. Create the Rear Chalk Line parallel to the Front Chalk Line. Make the Rear Chalk Line longer than the **Overall Width** setting.

The Front and Rear Chalk Lines **must** also be parallel to each other.

Measure to verify that they are parallel.

4. Before moving the Posts into position, measure **diagonally** to make sure the two diagonal measurements are the same. This ensures your layout is correct.

Do not forget to check the diagonals.

5. When you move the Posts into position, put the corners of the Base Plates inside the corners created by the four Chalk Lines.

Unloading and Unpacking

Once the components are unloaded, they are your responsibility to move around. As the Lift includes a number of heavy pieces, the closer you unload them to the installation location, the better off you are.

⚠ CAUTION Some Lift components are very heavy; if handled incorrectly, they can damage materials like tile, sandstone, and brick. Try to handle the Lift components twice: once when delivered and once when moved into position. You must have a Forklift or Shop Crane to move them into position. Use care when moving them.

⚠ WARNING The Posts and Runways are delivered with stabilizing structures on each end. Be very careful when removing these stabilizing structures; the Posts and Runways can shift or even fall. If they fall on a person, they could cause serious injury.

Moving the Posts into Position

Use a Forklift or Shop Crane to move the Posts, one at a time, to the inside corners of the Chalk Line Guides.

Important: Position the Power Post at your chosen location. Remember, the Power Post can only go in two possible locations: the **Front Driver-Side** or the **Rear Passenger-Side**. The other three Posts can go at any of the remaining Post locations. Refer to **Selecting the Lift Orientation** for more information.

Do not stand up the Posts yet, some of the following procedures are easier to complete if the Posts are laying on the ground.

Installing the Crosstubes

Your Lift has two Crosstubes, both hollow, which allows the Lifting Cables to be run through them to the Posts. The two Crosstubes are:

- **Crosstube with Large Windows:** Goes on the end of the Lift *opposite* of the Power Post, with the Windows facing the inside.
- **Crosstube with Small Windows:** Goes next to the Power Post, with the Windows facing the inside.

Important: It is possible to install the Crosstubes *incorrectly* in several different ways. Take your time now and get it right the first time.

The Crosstubes **must** be installed so that their Windows open to the **inside** of the Lift; the Crosstubes **must** also be installed so that their Windows are on the Powerside Runway side of the Lift (the Runway with the Hydraulic Cylinder).

The following drawing shows the two Crosstube setups based on the Power Post location.

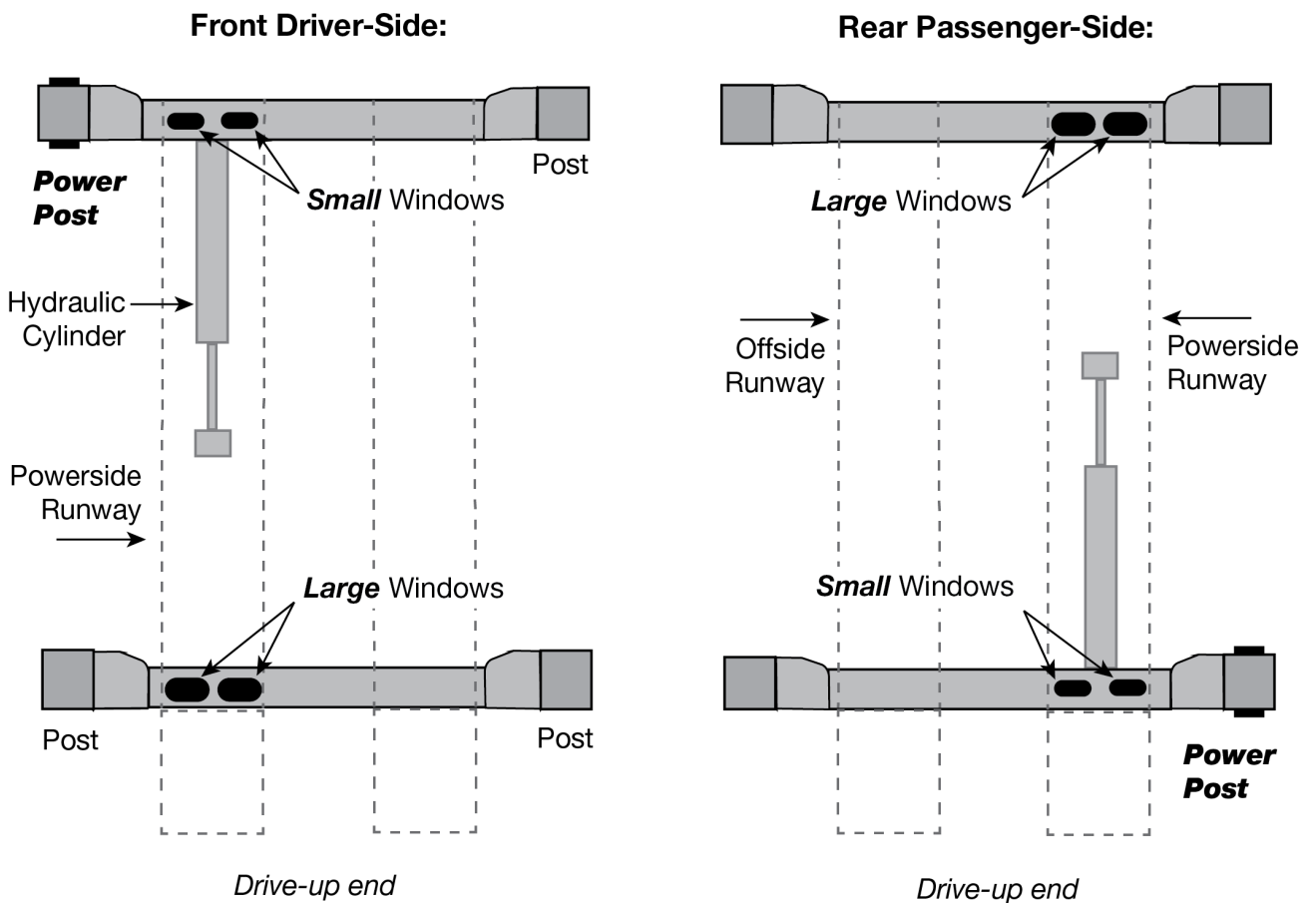

Top View. Not to scale. Some components not shown or exaggerated for clarity.

To install the Crosstubes:

1. Orient the Crosstubes in their required locations.

Both Windows **must** be on the ends of the Powerside Runway and facing the inside of the Lift.

2. Put black Slide Blocks into place on the outside ends of each Gusset (4 Slide Blocks per Gusset, 8 per Crosstube, 16 total for the Lift).

Align the holes in the Slide Blocks with the rods on the side of the Gusset, then press the Slide Blocks in. Make sure the Slide Blocks are oriented so that they create a Slot when pushed in.

The following drawing shows how to correctly install two Slide Blocks onto a Gusset.

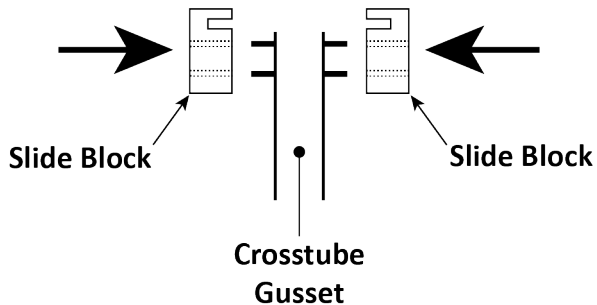

The four Slide Blocks on a Gusset, when put into place, create two Slots about four inches wide and half an inch deep. There is one Slot at the top of the Gusset and a second Slot at the bottom; the Ladder **must** go through **both** Slots on the Gusset.

⚠ WARNING If the Slide Blocks are not correctly installed, then the Slots for the Ladder are not created. In such a case, the Safety Locks will not work correctly, which endangers everyone who uses the Lift. Make sure to correctly install the Slide Blocks.

The following drawing shows the Slot created by two Slide Blocks.

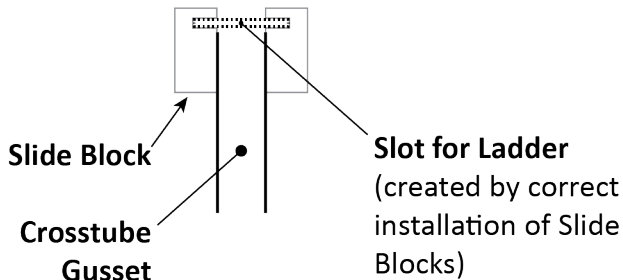

3. Using a Forklift or Shop Crane, raise the Crosstube with the Slide Blocks installed above the top of the two Posts that it goes between, lower it to just over the top of the Post, orient the Slide Blocks over the openings in the Post, then slide the Crosstube down.
4. Perform Steps 2 and 3 for the other Crosstube.

About Safety Locks

Safety Locks hold the Runways in place. Once engaged, Safety Locks hold the Runways in place, even if the power goes out or the Hydraulic Hoses break or leak. The Safety Locks are spaced every four inches / 100 mm. Each Post has its own Ladder and set of Safety Locks.

Important: Simply raising the Runways does *not* engage them on the Safety Locks. You must back the Runways down onto the Safety Locks to engage them.

⚠ WARNING Safety Locks are dependent on correct installation of the 'Ladders'. Pay careful attention when installing the Ladders, thus ensuring correct operation of the Safety Locks on your Lift.

The Ladders, one per Post, are steel pieces with holes spaced every four inches / 100 mm. As you raise the Runways, the Safety Locks move into the holes in the Ladder. When you move the Runways back down a little after passing a Safety Lock, the Safety Lock engages. Once they are engaged, Safety Locks stay engaged until you are ready to lower the Runways.

⚠ WARNING Always leave the Runways either fully lowered or engaged on their Safety Locks. When you engage the Safety Locks at a desired height, check to make sure that all four Safety Locks (one per Post) are engaged.

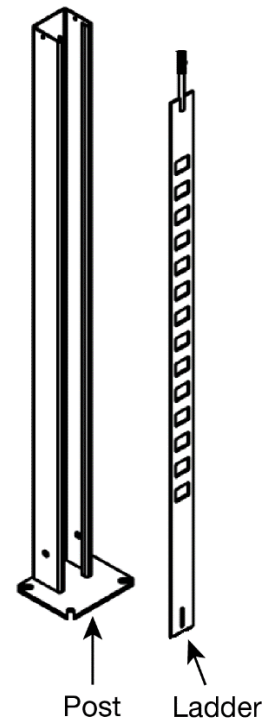

So how do the Runways come down if the Safety Locks are engaged? To lower the Runways, you *raise* them a few inches (to get them off the Safety Locks), then **press and hold down** the pushbutton on the Pushbutton Air Valve. While you hold down the pushbutton, the Safety Locks are moved away from the Ladders; in this position, they cannot engage, which allows the Runways to be lowered.

Out of an abundance of caution, your Lift has a second, independent Safety Lock system called the Slack Safety. In total, your Lift has two Safety systems:

- **Safety Locks:** The primary system to hold up the Runways on your Lift are the Safety Locks. When you move the Runways up, you can hear clicks as the Safety Locks go into the holes in the Ladders. When you want to keep the Runways at a certain height, you go slightly past the height you want, then back the Safety Locks down in to the holes in the Ladders, which engages them.
- **Slack Safety:** The Slack Safeties are next to the Safety Locks on the ends of the Crosstube Gussets. They are different from the Safety Locks in that when the Cables are taut (which they are during normal operation), they hold the Slack Safeties away from the Ladder so that the Slack Safeties cannot engage. However, if a Cable were to break (which very rarely happens), the Slack Safety for the broken Cable immediately engages, preventing the Runways from falling.

The Slack Safety Locks get engaged during installation when you raise the Crosstubes (see **Raising the Crosstubes**). Make sure to disengage them immediately after raising the Crosstubes.

Installing the Ladders and Top Cap

Each Post has a Ladder; each Ladder gets installed on the inside back of a Post. Ladders are secured at the top and the bottom. All four Ladders are identical.

It is **not** necessary to slide the Ladders in from the very top of the Post.

The Top Caps secure the Ladder at the top of each Post and hold the ends of the Lifting Cables.

Make sure to install each Ladder through **both slots** on each Crosstube Gusset.

Note: It is much easier to secure the bottom of the Ladders once the Crosstubes have been raised, so that portion of installing the Ladders is described in **Securing the Ladders**.

⚠ WARNING Make sure to install the Ladders correctly. If they are not installed correctly, the Safety Locks on your Lift may not hold the weight of a Vehicle, putting anyone under the Lift in danger.

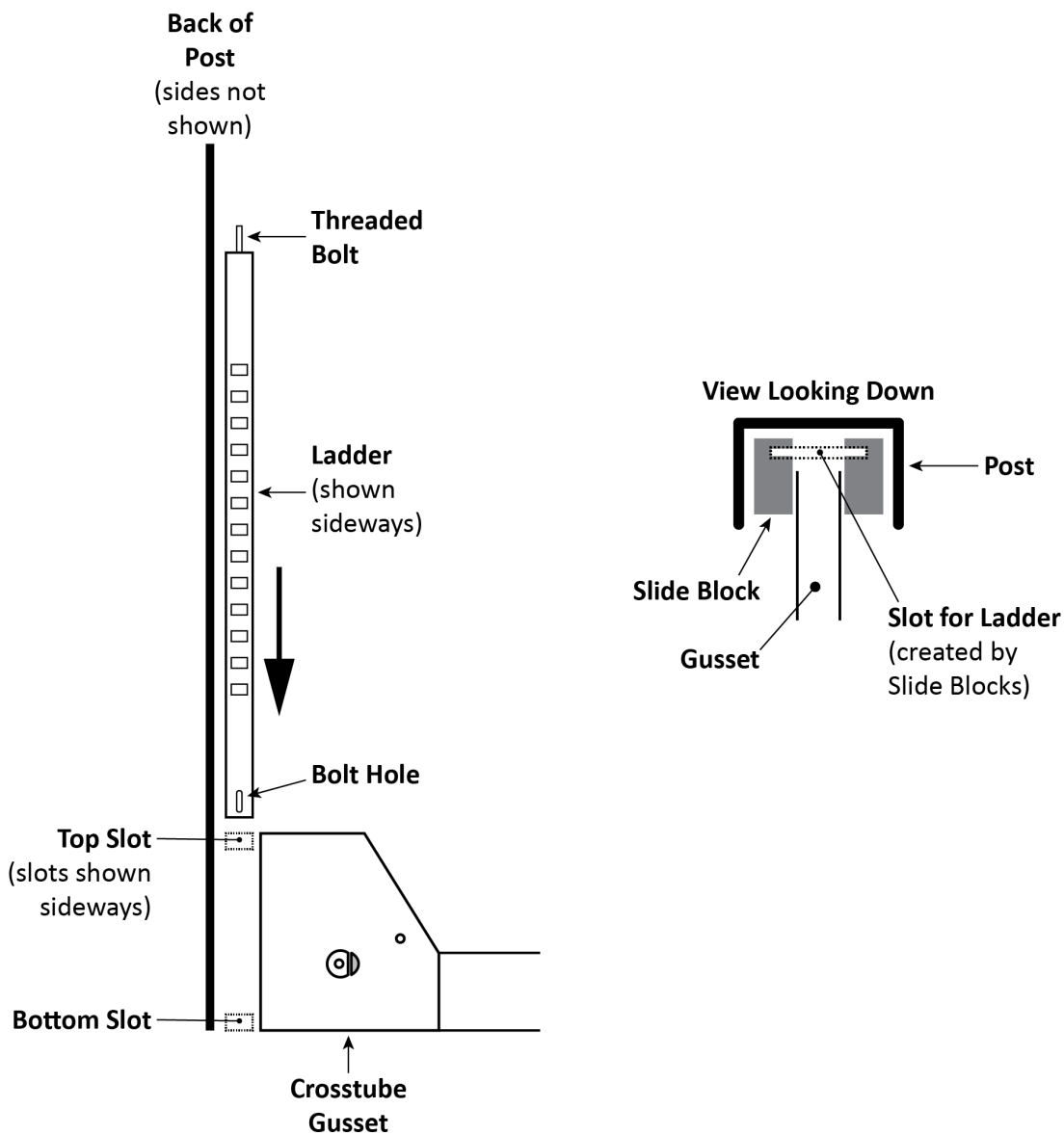

Top and Side view. Not necessarily to scale. Not all components shown.

To install the Ladders and the Top Caps:

1. Take a Ladder and slide it down the back of the Post, with the Bolt Hole end at the bottom.

Make sure the Ladder goes through both Slots on each Gusset. There is a Slot at the top of the Gusset and another Slot at the bottom of the Gusset, both formed by the Slide Blocks.

⚠ WARNING It is easy to see the top Slot created by the Slide Blocks. It is difficult to see the bottom Slot, but it is **required** that the Ladder goes through *both* Slots. If the Ladder misses a Slot or the Slide Blocks were not installed correctly, your Safety Locks will **not** function correctly.

2. Install the remaining Ladders the same way.
3. **Moving to the top of the Ladders**, put the Stop Nut on the Threaded Bolt at the top; move the Stop Nut down half an inch from the top of the Post.

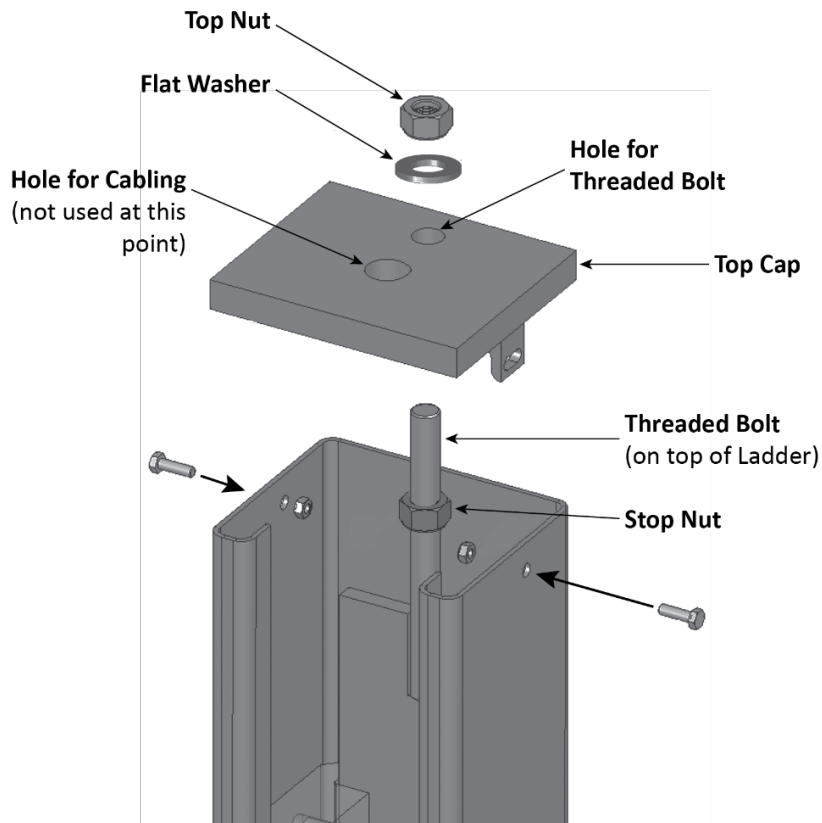

4. Put the Top Cap onto the top of the Post: put the Threaded Bolt on the top of the Ladder through the appropriate hole, put the tabs on the side of the Top Cap inside of the Post, and secure the Top Cap on both sides with one Hex Head Bolt and one Nyloc Nut per side.
5. Once the Top Cap is secure, move the Stop Nut up until it contacts the underside of the Top Cap, then add a Flat Washer and Nyloc Nut to the top of the Top Cap and tighten it. Only hand tighten at this point.

You are looking for about an inch of thread above the top of the Top Nut.

Note: The other hole in the middle of the Top Cap is for the Lifting Cable, installed later.

6. Install the remaining Top Caps the same way.

Raising the Crosstubes

You need to manually raise the Crosstubes, which makes it easier to complete the rest of the installation tasks. The Crosstubes need to be raised the same height, to the same Safety Lock.

To raise the Crosstubes:

1. Use a Forklift or Shop Crane to carefully raise each Crosstube.

You want to raise the Crosstubes at least two feet off the ground, to have enough room to work under it, making it easier to route the Lifting Cables and Lines.

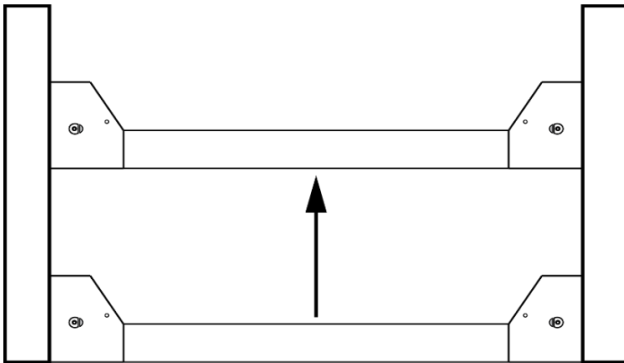

- Important:** *The Slack Safeties cannot be engaged as you continue with the installation.* Because the Cables are not in place yet, the Slack Safeties are going to engage when you manually raise the Crosstubes. You need to disengage them after you have raised the Crosstubes. The Primary Safeties are not impacted; they will engage normally when you manually raise each Crosstube, which is what you want.
2. To disengage the Slack Safeties after raising a Crosstube: raise and hold one end of a Crosstube so the Primary and Slack Safety Locks are disengaged, push and hold the Sheave or the Steel Piece in towards the Ladder and the back of the Post (this moves the Slack Safety Lock so it cannot to engage), lower the end of the Crosstube, then release the Sheave or Steel Piece.

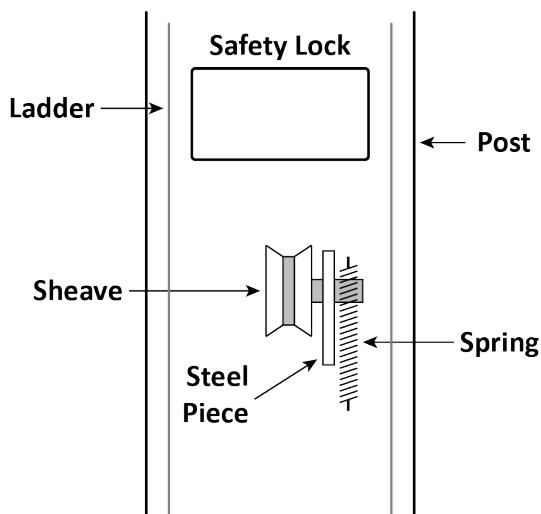

3. Disengage the other three Slack Safety Locks as done in Step 2.
4. Once both Crosstubes are in position, **all four Primary Safeties are engaged**, and all four Slack Safeties have been **disengaged**, you can continue with the installation.

Securing the Ladders

Because it is much easier to secure the Ladders at the bottom of each Post **after** the Crosstubes have been raised, that procedure is described here.

The following procedure assumes that the Ladders are in place and secured at the top. If this is **not** the case, return to **Installing the Ladders and Top Cap**.

To secure the Ladders:

1. Locate a Bolt, Washer, Spacer, second Washer, and Nut for each Ladder.

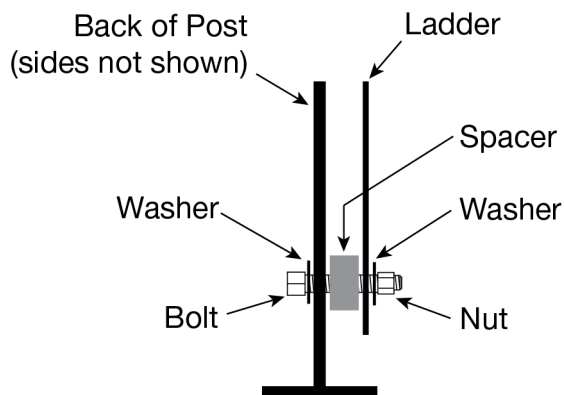

Side view of the Post. Not all components shown.

2. Put a Washer next to the Bolt head, then insert the Bolt just through the elongated hole near the bottom of the Ladder.
3. Put the Spacer into position between the Ladder and the back of the Post, then push the Bolt through the Spacer and then through the back of the Post.
4. Take the second Washer and the Nut and install them on the end of the Bolt; secure the Nut.
5. Repeat Steps 1 through 5 for the three remaining Ladders.

Note: Do not securely tighten the Top Nut at the top of the Top Cap at this point. The Top Nut and the Stop Nut will be used later to make sure the Lift is level. They can be securely tightened after you do the final leveling; refer to **Final Leveling** for additional information.

6. Make sure the Primary Safety Locks are engaged.

⚠ WARNING Do not continue with the installation until you have visually confirmed that all four Primary Safety Locks are engaged. If they are not engaged, the Runways could move or fall, possibly causing injury (even death) or product damage.

7. Stand up each Post. Have at least two people work together to stand up a Post.

⚠ CAUTION Use caution when walking around the Posts; they are not anchored down at this point, so it is possible to knock them over, which could cause injury.

8. Use a Transit Level to estimate the Shim requirements: use a target to find the difference in height between the Posts. The difference is the estimated amount of Shim thickness you will need.

Do not use Shims and/or Anchor Bolts to shim more than 1/2 an inch.

Do not anchor the Posts at this point. You may or may not be anchoring the Posts at all, depending on whether or not you are going to use the optional Caster Kit. But even if you plan to anchor the Posts *eventually*, do not anchor the Post now.

Removing the Sheaves

In order to route the Lifting Cables, you need to remove the Cable Sheaves on the underside of the Powerside Runway and the four Gusset Sheaves and their Lock Pins.

When you remove the Sheaves, **keep the components together**. You will be reinstalling them at the same location, using the same components.

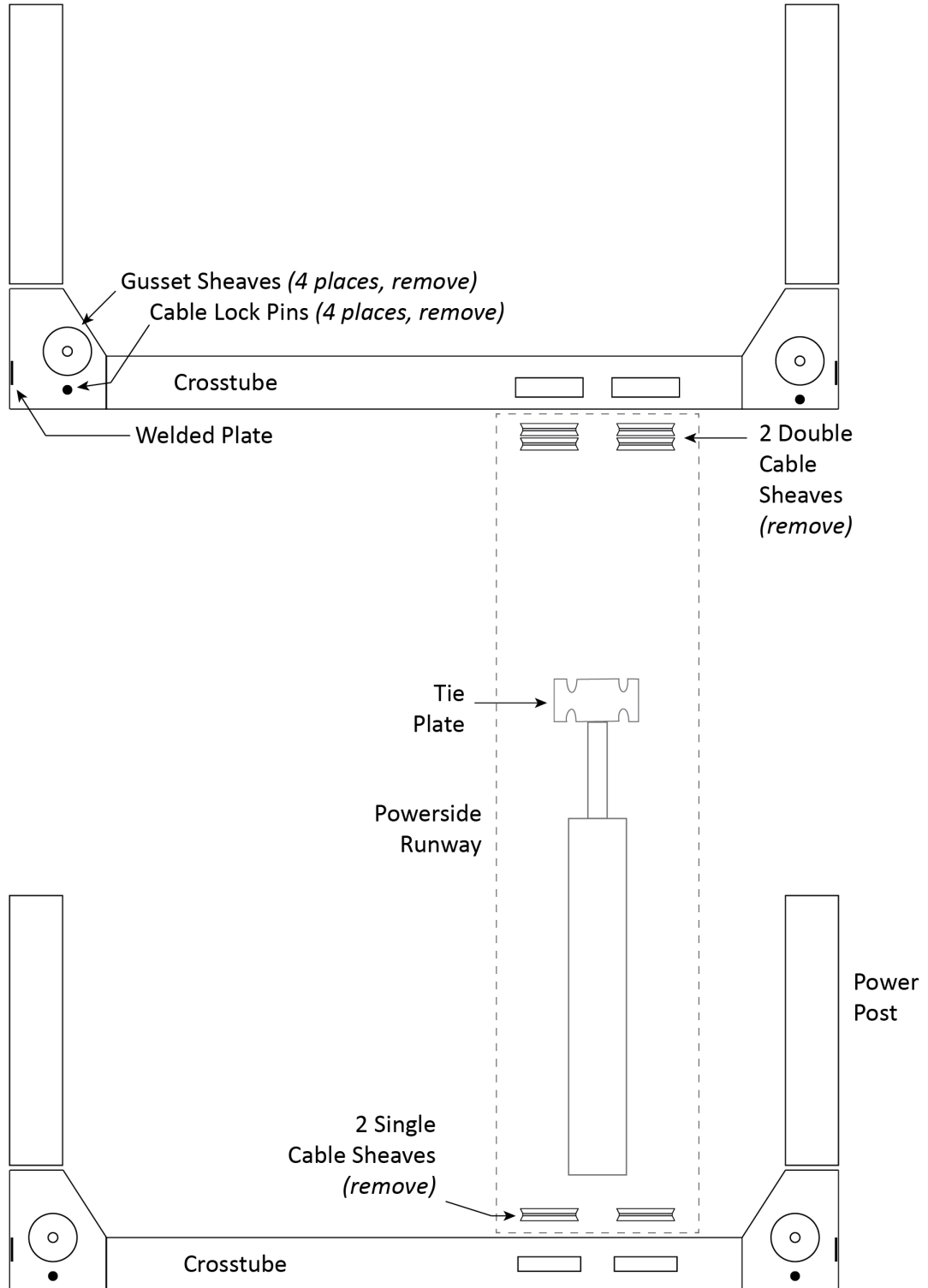

Drawing combines Top and Side views. Not necessarily to scale. Not all components shown.

Installing the Runways

Your Lift has two Runways:

- **Powerside Runway:** Holds the Hydraulic Cylinder underneath it. Has a hole on the outside Rear that lets you route the Hydraulic Hose, Air Lines, and Return Line to the Power Unit. Cable routing starts under the Powerside Runway.
- **Offside Runway:** The Offside Runway does not have a Hydraulic Cylinder under it, nor are there any Lifting Cables under it. It can be installed in the wide or narrow setting; ***the adjustable setting does not apply to the HD-9ST or HD-9STX models.***

Orient the two Runways this way:

- Utility Rails on the inside
- Find the Powerside Runway by looking under the two Runways (only the Powerside Runway has a Hydraulic Cylinder underneath it) and put it next to the Power Post.

There is also an ~1.5-inch wide hole in the side of the Powerside Runway at the Power Post for the Flex Tube (which holds the Air, Return, and Hydraulic Hose).

The following drawing shows the correct orientation of the Runways for both Power Post locations.

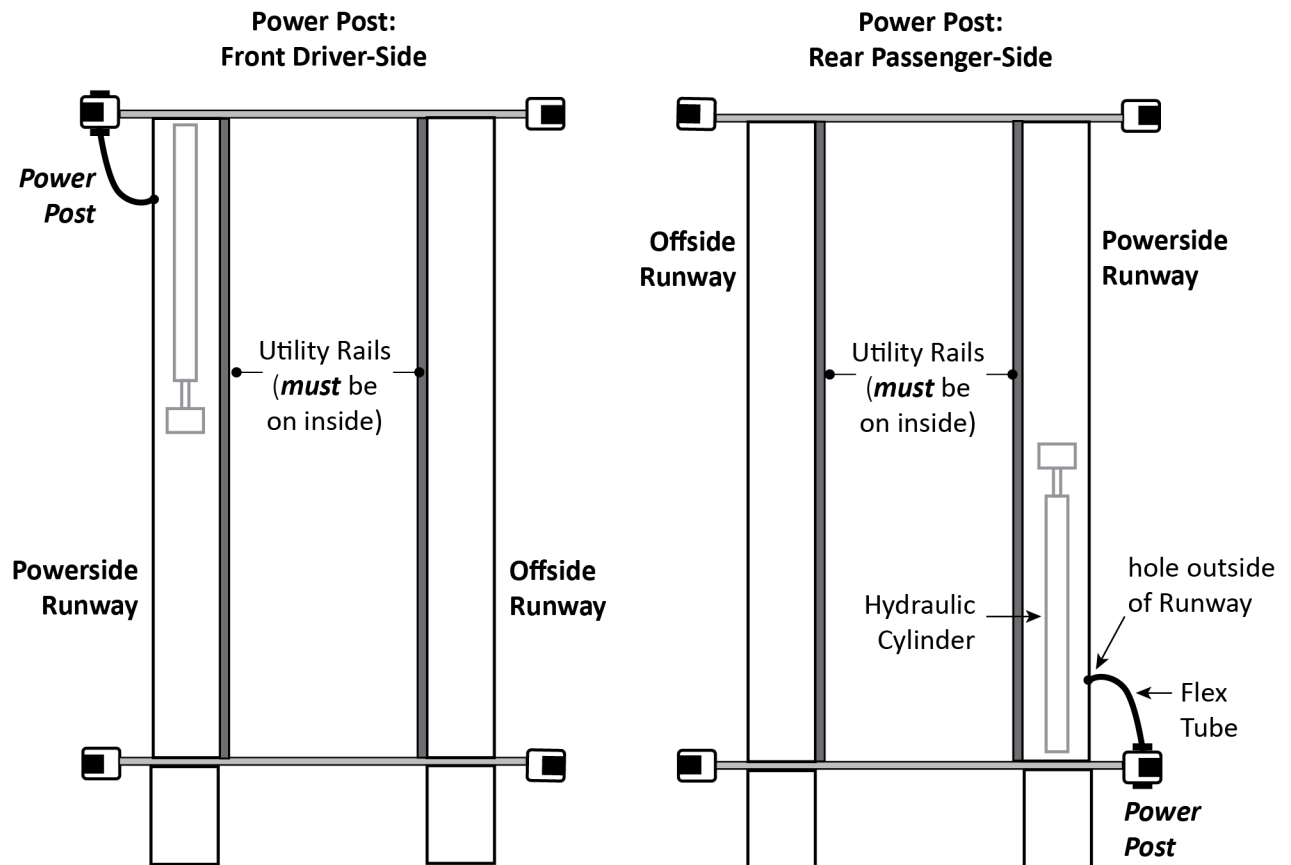

Top View. Not drawn to scale. Not all components shown.

Use a Forklift or Shop Crane to raise the Runways and move them into position.

 **WARNING** Pay close attention when moving the Runways into position; they are very heavy and long, and could shift position or fall, potentially causing serious injury.

To install the Runways:

1. Correctly orient the Powerside Runway and the Offside Runway.
The Powerside Post must go next to the Power Post.
2. On the underside of the Powerside Runway, make sure the Sheaves have been removed.
3. Use a Forklift or Shop Crane to pick up the Powerside Runway and move it into place.
Make sure the Utility Rail is on the inside.
4. Bolt the Powerside Runway into place, two Bolts on each end going into the Crosstubes.
Use four M12 by 1.75 by 90 Hex Head Bolts.
5. Use a Forklift or Shop Crane to pick up the Offside Runway and move it into place.
6. Bolt the Offside Runway into place, two Bolts on each end going into the Crosstubes.
Make sure the Utility Rail is on the inside.

Important: The Offside Runway **must** be bolted on both ends when using the optional Rolling Jack.

7. Make sure that the Primary Locks are engaged.

 **WARNING** Do not continue with the installation until you have visually confirmed that all four Safety Locks are engaged. If they are not engaged, the Runways could move or fall, possibly causing personal injury or product damage.

Installing the First End of the Flex Tube

The Flex Tube is a flexible, black tube that attaches to an opening on the Powerside Runway on one end and to the bottom of the Flex Tube Bracket Plate (near the Power Unit) on the other end.

The Flex Tube consolidates and protects three different Cables that come out from under the Powerside Runway on their way to the Power Unit: The Return Line, the Air Line, and Hydraulic Hose.

The Flex Tube is about 52 in / 1,320 mm long and about 1.5 in / 38 mm wide. Both ends of the Tube are the same.

Installation of the Flex Tube is done in two parts: the first part is completed after the Runways are installed (now), the second part after the Power Unit (and the Flex Tube Bracket Plate) is installed later.

The following drawing shows the Flex Tube.

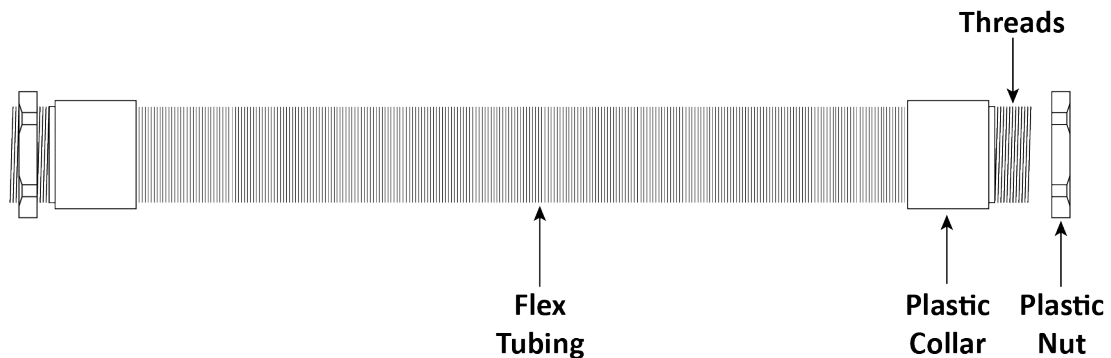

Side view. Not drawn to scale. Not all components shown.

To install the Flex Tube to the Powerside Runway:

1. Unscrew the Plastic Nut from one end of the Flex Tube. It does not matter which end you use.
2. Holding the Flex Tube by the Plastic Collar, put the Threads on the end of the Flex Tube through the hole on the Powerside Runway.

The hole is about 1.5 in / 38 mm wide.

The Threads go into the holes until they are accessible from the inside, while the rest of the Flex Tube stays outside.

3. On the inside of the Powerside Runway, screw the Plastic Nut back onto the Threads of the Flex Tube and tighten it.
4. Let the other end of the Flex Tube hang in place for now.

Routing the Lifting Cables

Before routing the Lifting Cables on your Lift, you need to know the following:

- BendPak strongly recommends using protective gloves when working with the Lifting Cables.
- Each Lift has four Lifting Cables of varying lengths and can only make one connection.
- All Lifting Cables have a Button End and a Threaded End. The Threaded End has a label on it that identifies the Lift model the Cable is designed for (and **must** be used with), the part number (if you need to replace it), and its length (in millimeters).

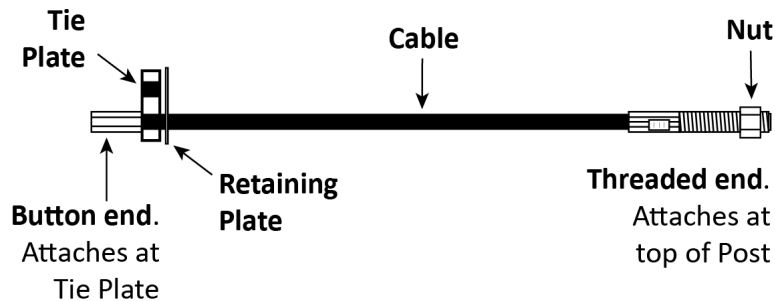

- The Button End of each Lifting Cable connects at the Tie Plate on the underside of the Powerside Runway. The Button Ends of each Lifting Cable stay on one side of the Tie Plate (as shown above), while the rest of the Cable goes through the Tie Plate and the Retaining Plate on its way towards the appropriate Sheaves and then to the Posts to which it attaches.
- The Threaded End of each Lifting Cable goes around the appropriate Sheaves and then gets routed to a Post, where it is attached at the top.
- Before routing each Lifting Cable, remove the Nut at the Threaded End; you cannot route the Lifting Cable around the Sheaves if the Nut is still on.
- The Lift comes with a Retaining Plate on one side of the Tie Plate. The Retaining Plate holds the Button Ends of the Lifting Cable in place after all four Cables are installed. **Do not take the Retaining Plate off to install the Lifting Cables**; instead, loosen it so that you can slip the Button End of the Cable into the correct slot. When all four Lifting Cables are installed, tighten the Retaining Plate.
- There are two kinds of Sheaves: *Cable Sheaves* and *Gusset Sheaves*. There are four Cable Sheaves (two Double Cable Sheaves) in the Crosstube with Large Windows and two Single Cable Sheaves in the Crosstube with Small Windows, for a total of six Cable Sheaves. There are four Gusset Sheaves, one per Crosstube Gusset.
- All Sheaves come installed. They should have been removed earlier in the installation prior to installing the Runways.
- A Lifting Cable and its corresponding Cable Sheave (or Sheaves) are put into place one at a time, starting from the top of the Post to the Tie Plate.
- The Crosstube with Large Windows has two Double Cable Sheaves (also called twin Cable Sheaves), so the two Lifting Cables that share a Double Cable Sheave are routed around the same time; for example, Lifting Cables A and C are routed around the same time because they share a Double Cable Sheave, and same for Cables B and D.
- Each Crosstube Gusset has a Cable Lock Pin underneath the Gusset Sheave. Each Cable Lock Pin needs to be removed when routing the Cable to its Post and then reinstalled once the Cable is in place.
- The Cable Lock Pin prevents the Cable from coming out later; there is not enough space between the bottom of the Gusset Sheave and the Cable Lock Pin for the Cable to slip out.

-
- In the following drawings, the Cables and Cable Sheaves are labeled A, B, C, and D. These letters are **not** on the label on the Threaded end. You have to match the Cable letter with the length.
 - The four Lifting Cables for the **HD-9ST** are:
 - **A: 2,926** mm / 9.7 feet / 115.25 inches
 - **B: 4,356** mm / 14.4 feet / 171.5 inches
 - **C: 7,048** mm / 23.2 feet / 277.5 inches
 - **D: 8,476** mm / 27.10 feet / 333.75 inches
 - The four Lifting Cables for the **HD-9STX** are:
 - **A: 3,240** mm / 11 feet / 127.5 inches
 - **B: 4,663** mm / 15 feet / 183.5 inches
 - **C: 7,978** mm / 26 feet / 314 inches
 - **D: 9,404** mm / 30 feet / 370.25 inches
 - The four Lifting Cables for the **HD-9** are:
 - **A: 2,958** mm / 9.9 feet / 116.5 inches
 - **B: 4,578** mm / 15 feet / 180.25 inches
 - **C: 7,094** mm / 23.4 feet / 279.25 inches
 - **D: 8,706** mm / 28.7 feet / 342.75 inches
 - The four Lifting Cables for the **HD-9XL** are:
 - **A: 3,582** mm / 11.9 feet / 141 inches
 - **B: 5,195** mm / 17 feet / 204.5 inches
 - **C: 8,332** mm / 27.4 feet / 328 inches
 - **D: 9,932** mm / 32.7 feet / 391 inches
 - The four Lifting Cables for the **HD-9XW** are:
 - **A: 3,263** mm / 10.8 feet / 128.5 inches
 - **B: 4,883** mm / 16 feet / 192.25 inches
 - **C: 8,007** mm / 26.3 feet / 315.25 inches
 - **D: 9,613** mm / 31.7 feet / 378.5 inches

Important: Make sure to use the correct Lifting Cable for each routing. If you put a Cable in the wrong place, it will be too short or too long. Remember that the length of each Cable is printed on the label on the Threaded end.

- Lifting Cables A and B pass around one Cable Sheave and one Gusset Sheave. Lifting Cables C and D pass around *two* Cable Sheaves and one Gusset Sheave. See the drawing on the following page for routing information.

The following drawing shows the components involved in routing the Lifting Cables.

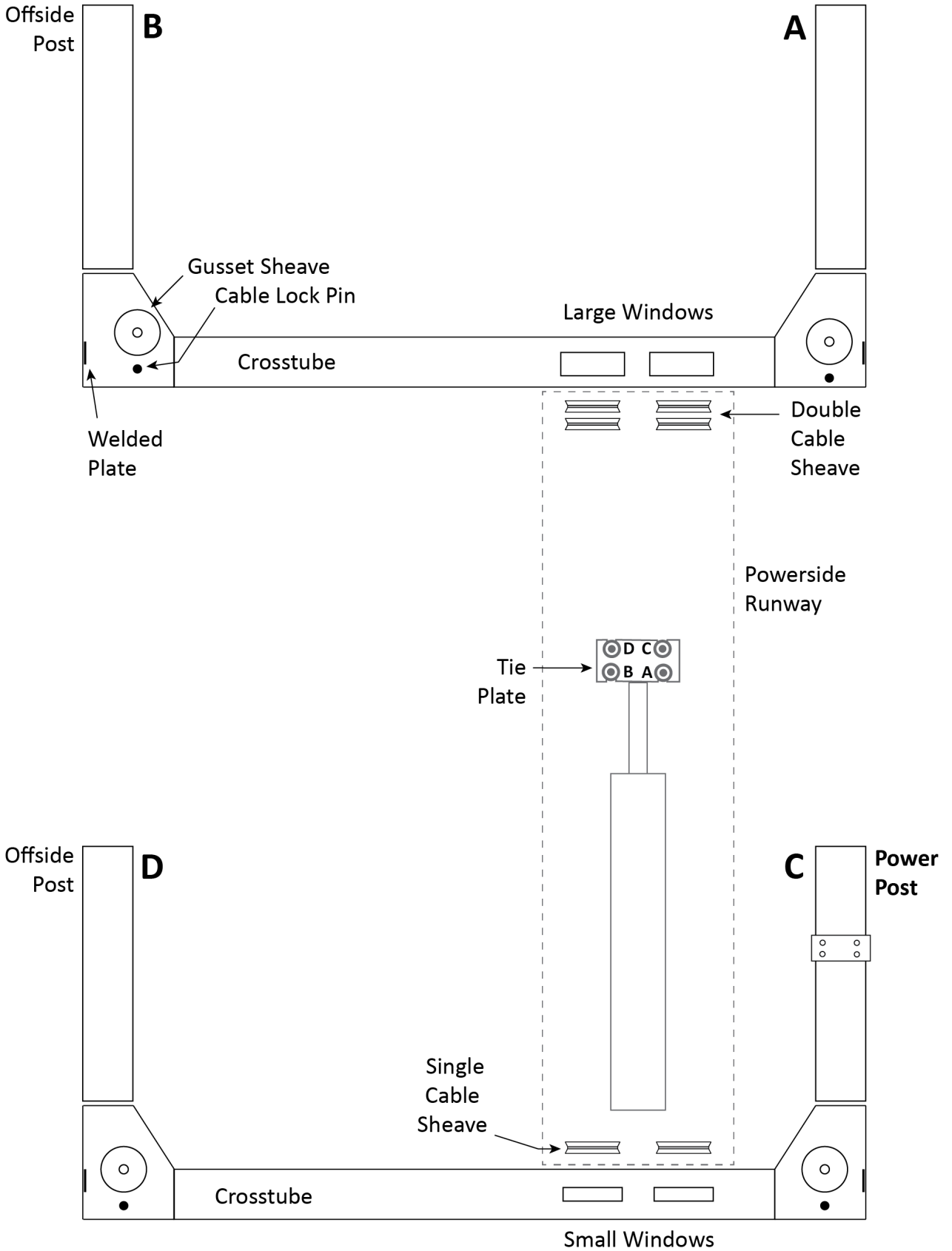

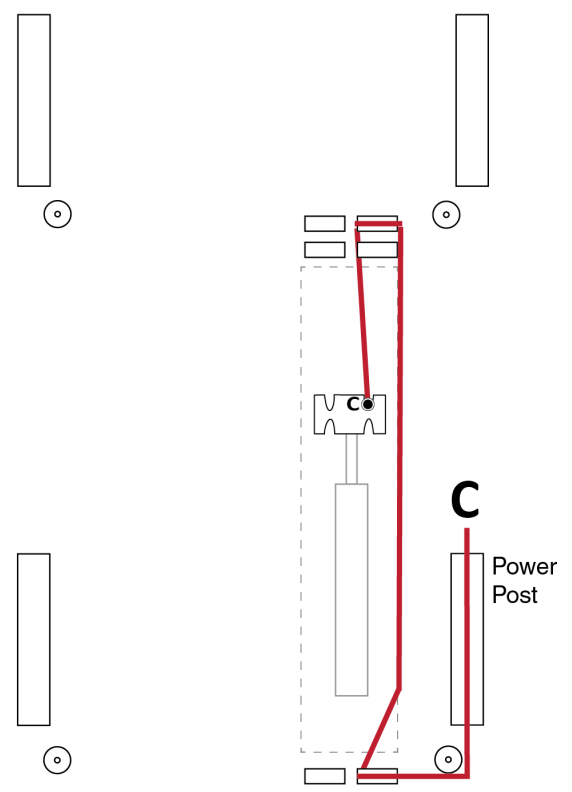
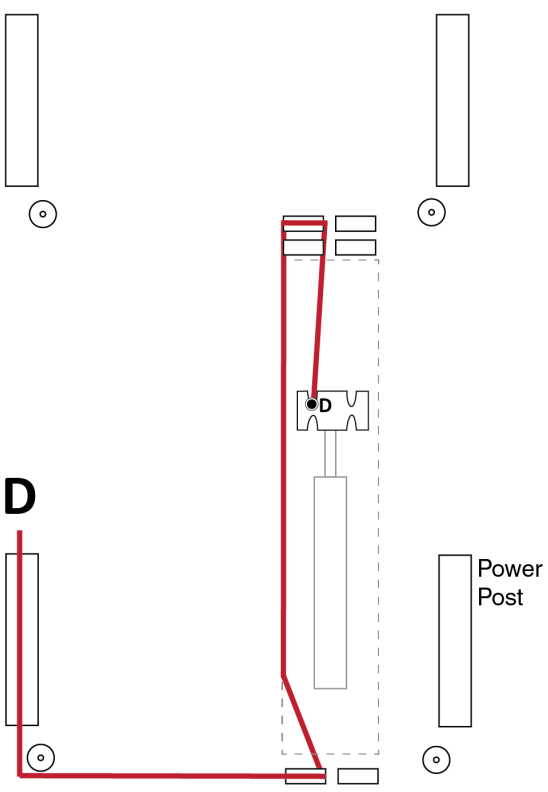
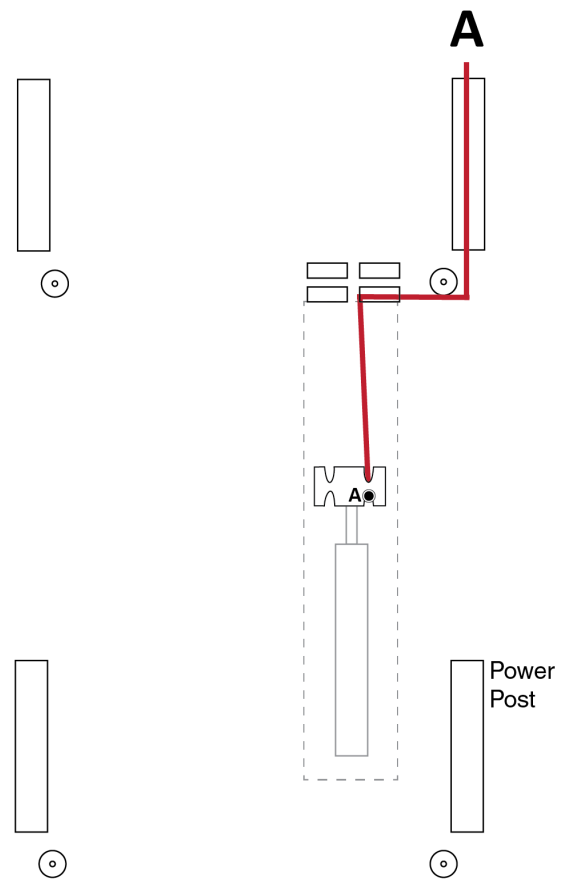
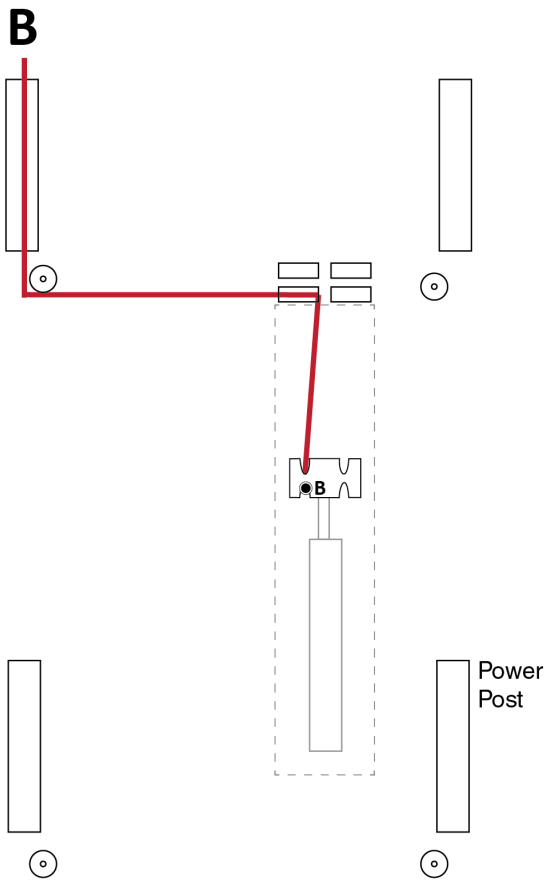

Before routing the Cables, extend the Piston on the Hydraulic Cylinder.

To extend the Piston:

1. Remove the Shipping Plug from the Return Line Connector.
The Return Line Connector is on the Cylinder end closest to where the Power Unit will be.
2. Attach an air pressure source to the Return Line Connector.
3. Use the air pressure to extend the Hydraulic Cylinder's Piston and Retaining Plate.

Do not exceed 50 psi.

If the Cylinder does not move, stop using air pressure; instead, use a pulling device (such as a Come Along Tool) to extend the Piston and Retaining Plate; be care not to damage the Piston.

4. Reinstall the Shipping Plug to the Return Line Connector.

The following procedure assumes you have nearby the four Lifting Cables and Sheaves you removed prior to installing the Runways.

To route Lifting Cables A and C:

1. **Starting with Lifting Cable A**, move the entire thing to just under the Large Window it goes through, near the bottom of Post A.
Check the label to make sure you have the correct Lifting Cable.
2. Remove the Nut and Washer from the Threaded End (but keep it nearby, you will need it soon).
3. Route the Threaded End of Lifting Cable A into its Large Window on the Crosstube, push it towards Post A, and then pull the Threaded End out of the Crosstube at the bottom of the Gusset.
4. Route the Threaded End of Lifting Cable A under where the Gusset Sheave will go when it is reinstalled, then route it up past the top of the Crosstube Gusset.

The following drawing shows how to route the Lifting Cable through the Gusset.

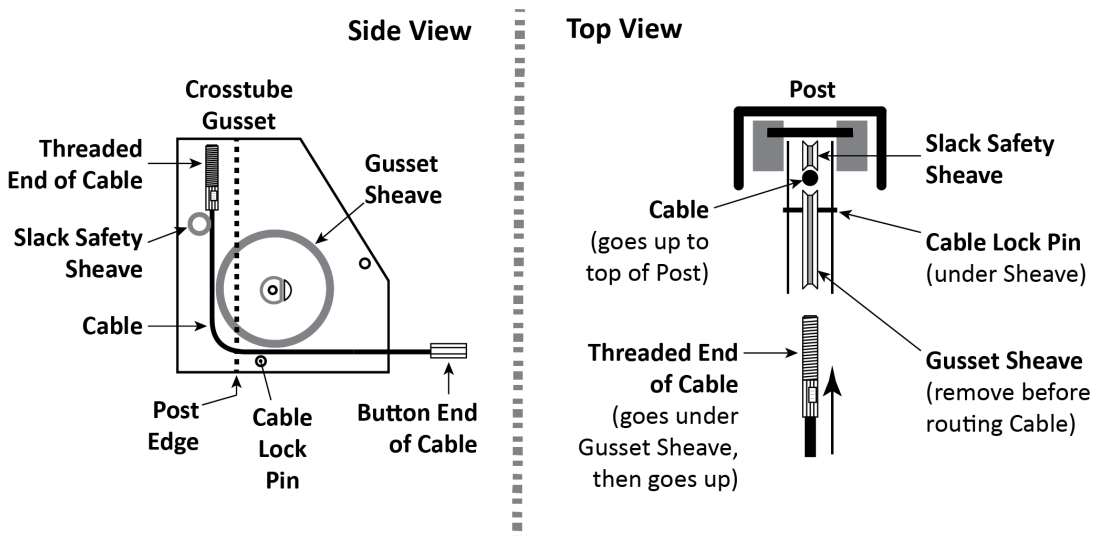

Important: When routing a Lifting Cable in its Post, the Cable must go **under** the Gusset Sheave and be on the side of the Slack Safety Sheave. When the Cables are pulled tight, the Cable prevents the Slack Safety from engaging, which is what you want. If the Cable is **not in this exact location**, the Slack Safeties will **not** work correctly.

5. With the Lifting Cable in place, reinstall the Gusset Sheave and the Cable Lock Pin in Post A.
6. Make sure Lifting Cable A is correctly positioned: in between the Gusset Sheave and the Slack Safety Sheave, with the Cable Lock Pin **under** it.
7. Push the Threaded End of Lifting Cable A up to and through the Top Cap (at the top of the Post) and **hand tighten** it in place with the Nut and Washer you removed earlier.

You only want to hand tighten the Nut at this point so that there is little play in the cabling. We will securely tighten all four Nuts later in the installation procedure.

8. **Switching to Lifting Cable C**, repeat Steps 1 through 7 for Lifting Cable C, starting at the Small Window near the bottom of Post C (the Power Post).
9. Reinstall a Single Cable Sheave and then make sure Lifting Cable C is correctly positioned in the Cable Sheave in the Small Window.
10. Under the Powerside Runway, move the rest of Lifting Cable C back towards the Crosstube with Large Windows.
11. Reinstall the Double Cable Sheave in place in the Large Window, making sure Lifting Cable A is seated in the Bottom Sheave and Lifting Cable C is seated in the Top Sheave, as shown below.

The following drawing shows the Cable/Cable Sheave pairs in the Crosstube with Large Windows.

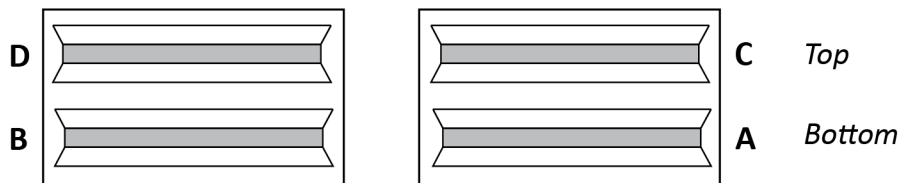

Front view. Double Cable Sheaves separated for easier understanding. Not all components shown. Not necessarily to scale.

12. By the Hydraulic Cylinder, loosen the Retaining Plate enough to give you room to slip the Button End of each Cable into its spot on the Tie Plate.

Do not take the Retaining Plate off, just loosen the Retaining Plate enough to give you enough room to slip the Button End of each Lifting Cable into place.

13. Pull the Button Ends of Lifting Cables A and C back towards the middle of the Runway, past the Retaining Plate, and into its slot on the Tie Plate.

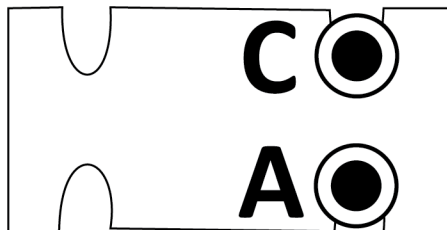

Drawing shows a front view of the Tie Plate, facing towards the Crosstube with Large Windows. Lifting Cables A and C are now correctly routed to their Posts.

Routing Lifting Cables B and D is the same process as routing Lifting Cables A and C, just to the other two Posts and using a different set of Sheaves. Refer to the drawings in the previous section.

To route Lifting Cables B and D:

1. **Starting with Lifting Cable B**, move the entire thing to under the Large Window it goes through, opposite of Cables A and C (already in place).

Check the label to make sure you have the correct Lifting Cable.

2. Remove the Nut and Washer from the Threaded End (but keep it nearby, you will need it soon).
3. Route the Threaded End of Lifting Cable B into its Large Window, push it towards Post B, and then pull the Threaded End out of the Crosstube at the bottom of the Gusset.
4. Route the Threaded End of Lifting Cable B just under where the Gusset Sheave will go when it is reinstalled, then route it up past the top of the Crosstube Gusset.

Important: When routing a Lifting Cable in its Post, the Cable must go **under** the Gusset Sheave and be on the side of the Slack Safety Sheave. When the Lifting Cables are pulled tight, the Lifting Cable prevents the Slack Safety from engaging, which is what you want. If the Cable is **not in this exact location**, the Slack Safeties will **not** work correctly.

5. With the Lifting Cable in place, reinstall the Gusset Sheave and Cable Lock Pin in Post B.
6. Make sure the Lifting Cable is correctly positioned: in between the Gusset Sheave and the Slack Safety Sheave, with a Cable Lock Pin **under** it.
7. Push the Threaded End of Lifting Cable B up to and through the Top Cap (at the top of the Post) and **hand tighten** it in place with the Nut and Washer you removed earlier.

You only want to hand tighten the Nut at this point so that there is little play in the cabling. We will securely tighten all four Nuts later in the installation.

8. **Switching to Lifting Cable D**, repeat Steps 1 through 7 for Lifting Cable D, starting at the other Small Window next to Lifting Cable C.
9. Reinstall the other Single Cable Sheave and then make sure Lifting Cable D is correctly positioned in the Cable Sheave in the Small Window.
10. Under the Powerside Runway, move the rest of Lifting Cable D back towards the Crosstube with Large Windows.
11. Reinstall the other Double Cable Sheave in the Large Window, making sure Lifting Cable B is seated in the Bottom Sheave and Lifting Cable D is seated in the Top Sheave.
12. Pull the Button Ends of Cable B and D back towards the middle of the Runway, past the Retaining Plate, and into its Slot on the Tie Plate.

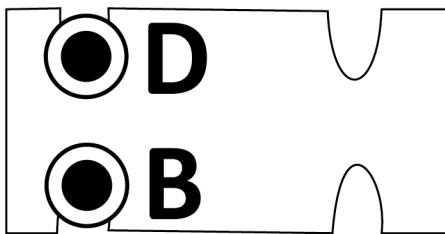

Drawing shows a front view of the Tie Plate, facing towards the Crosstube with Large Windows.

Lifting Cables B and D are now correctly routed to their Posts.

Working with Compression Fittings and Tubing

Your Lift comes with a roll of ¼ inch, black, polyethylene Tubing (also called Poly-Flo® Tubing) that is used with Compression Fittings in two ways: for the Return Line and for the Air Lines.

Important: While both lines use Tubing and Compression Fittings, the Return Line and Air Lines are used for completely separate purposes; do not connect the two together.

Note: Compression Fittings are different from Hydraulic Fittings. This section covers Compression Fittings only.

The components involved with Compression Fittings include:

- **¼ inch, black, polyethylene Tubing.** You use a single piece of Tubing for the Return Line. The Air Lines require multiple Tubing pieces. Create the Tubing pieces for both the Return Line and the Air Lines by cutting lengths from the long roll of Tubing supplied with your Lift.
- **Elbow Compression Fittings.** The Hydraulic Cylinder uses an Elbow Compression Fitting and then one Elbow Compression Fitting goes on the Power Unit.
- **Tee Compression Fittings.** The Air Lines requires three Tee Compression Fittings.
- **Nuts, Ferrules, Rods, and Threads.** Each connector on Elbow and Tee Compression Fittings have a Nut, Ferrule, Rod, and Threads (see drawing below). The Nut holds the Tubing and Fitting together. The Ferrule compresses when you tighten the Nut on the Threads to make a secure connection. The Rod goes inside the Tubing so that nothing leaks out.

The following drawing shows the components of a connector on a Tee Compression Fitting.

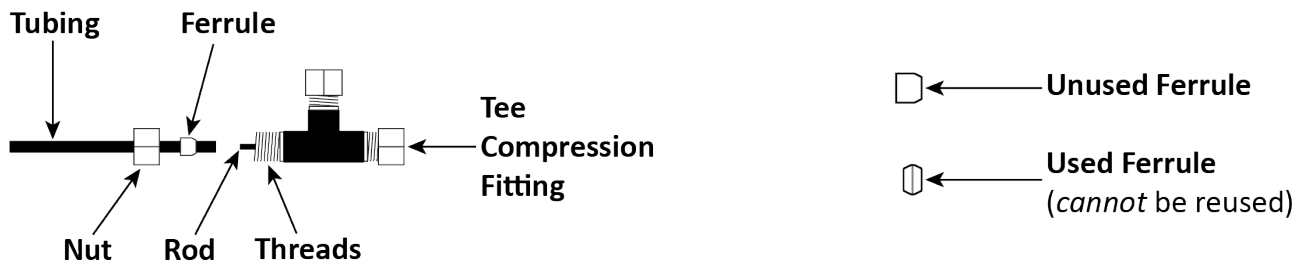

Important: *Ferrules can only be tightened once.* When you tighten the Nut on the Threads, the Ferrule gets compressed; it literally changes shape and **cannot** be used again.

To connect Tubing to a Compression Fitting:

1. Push the Tubing through the Nut and over the Rod.

Do not push hard; you only need the Tubing to go a little way over the Rod. You cannot see the Ferrule at this point, but the Tubing must go through the Ferrule and over the Rod.

2. Slide the Nut on the Tubing **away from the Fitting**, if the Nut is still on the Threads, unscrew it from the Threads and then slide it away from the Fitting. See the drawing above.
3. Slide the Ferrule over the Tubing, away from the Fitting and towards the Nut.
4. With the Nut and the Ferrule out of the way, push the Tubing further over the Rod until it stops.
5. Slide the Ferrule and the Nut back to the Threads on the Fitting.

The Ferrule goes around the Rod and under the Threads. The Nut goes onto the Threads.

6. Tighten the Nut.

Remember that the Ferrule can only be used once; do not tighten the Nut until everything is ready.

Installing the Air Lines

The Air Lines use air pressure to disengage the Safety Locks in each Post so that you can lower the Runways. You will need more of the ¼ inch, black, polyethylene Tubing that came with the Lift and three Air Line Tee Connectors to install the Air Lines.

An Air Supply (3 to 25 cfm at 50 – 150 psi) is required to disengage the Safety Locks.

⚠ CAUTION **Do not let the Air Supply exceed 150 psi**, the Air Lines could burst or the Safety Locks malfunction.

The Air Line Elbow Connectors on the Air Cylinders come installed from the factory.

Important: Do not confuse the Air Lines with the Return Line. They use the same Tubing and similar-looking connectors, but they are used for completely different things; the two systems cannot be connected to each other.

The Air Line Elbow Connectors on the Crosstube Gussets come installed from the factory.

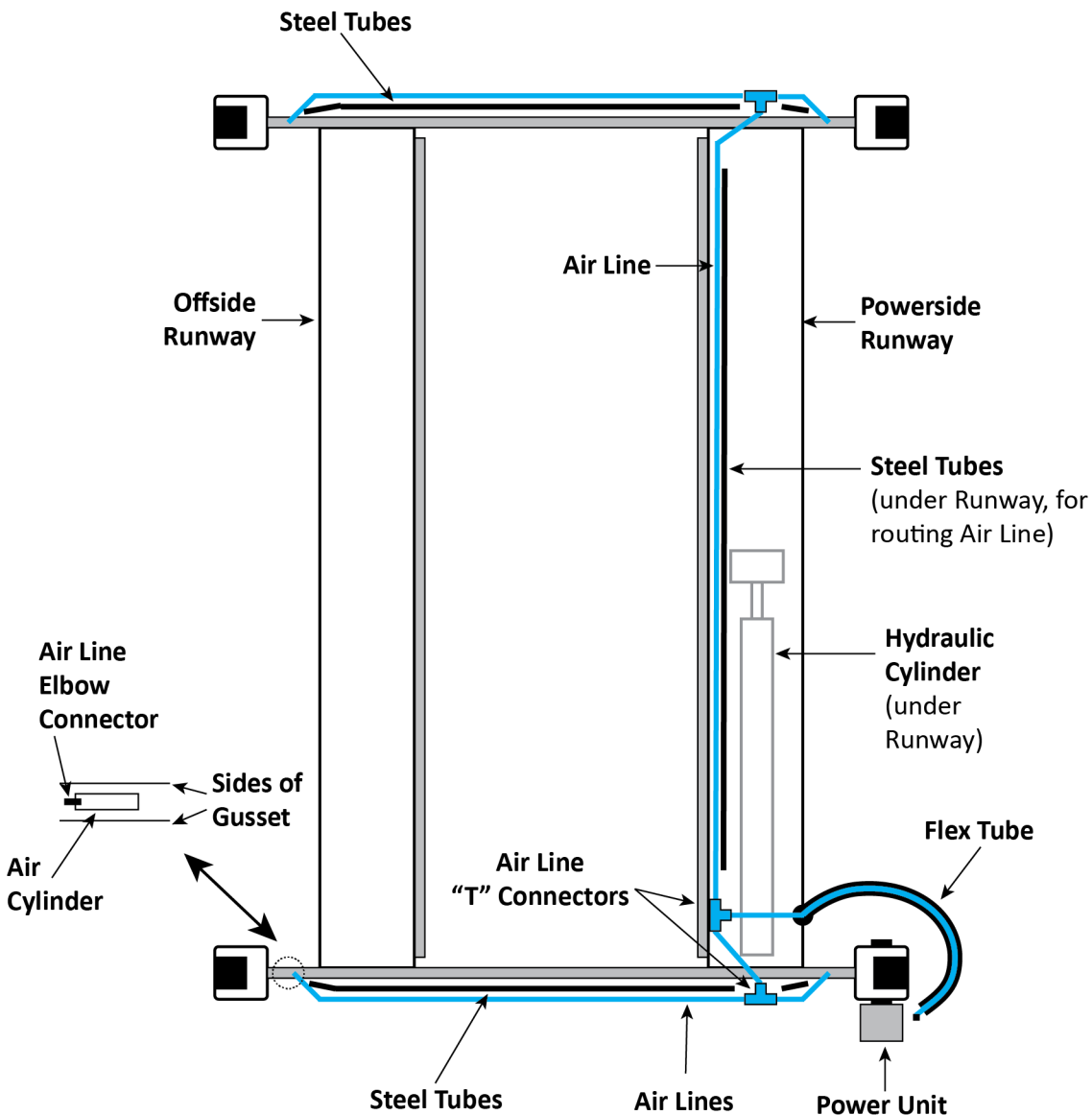

Air Lines shown outside Steel Tubes for clarity. Drawing not to scale. Some components not shown.

To install the Air Lines:

1. Find the roll of supplied ¼ inch, black, polyethylene Tubing and three Air Line Tee Connectors.
2. Measure the distances for each of the seven (7) Tubing pieces you will need (see the drawing on the previous page) for the Air Lines.
3. Cut seven pieces of Tubing to the measured lengths from the roll of Tubing.
4. Connect the various pieces of Tubing to the Air Line Tee Connectors on the Lift, as shown in the drawing on the previous page for the locations of the Tubing pieces.

Make sure to position the three Air Line Tee Connectors as shown in the drawing.

Also, route the long Tubing piece that goes under the Powerside Runway through the Steel Tubes; they keep Air Lines are out of the way of where the Cables will be routed.

 **WARNING** Make sure to route the Tubing pieces on the **outside** ends of the Front and Rear Crosstubes through the Steel Tubes on the ends of the Crosstubes. This keeps the Tubing and the Tee Connectors from being disturbed as you use the Lift. This is important, because if the Air Lines are disturbed, the Safety Locks on the Lift may not work correctly. If you notice that Tubing has become disconnected from an Air Line Tee Connector, take the Lift out of service and get the Air Lines fixed.

Refer to **Working with Compression Fittings and Tubing** for more information about connecting the Tubing to the Air Line Tee Connectors.

5. Leave the Power Unit end of the Air Line hanging out of the Flex Tube opening for now. It will be connected to a Tee Fitting and the Pushbutton Air Valve later.

Installing the Return Line

The Return Line takes excess Hydraulic Fluid coming out of the Hydraulic Cylinder and sends it back into the Fluid Reservoir on the Power Unit.

The Return Line is a single piece of ¼ inch, black, polyethylene Tubing with Elbow Compression Fittings on each end. You need to cut off a piece of the supplied Tubing of the right length to create the Return Line.

Important: The Return Line uses the same ¼ inch, black, polyethylene Tubing as the Air Lines. Be sure not to confuse the two; the Return Line and the Air Lines do completely different things and **must** be kept separate from each other.

The following drawing shows where the Return Line connects on the Lift.

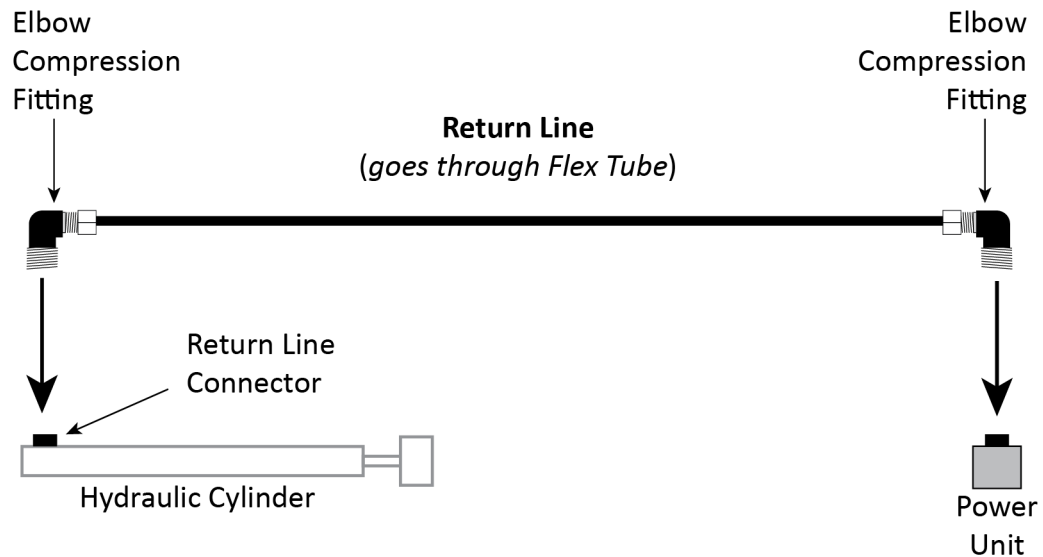

Front view. Drawing not to scale. Some components exaggerated for clarity.

To install the Return Line:

1. Measure the distance from the Return Line connector on the Hydraulic Cylinder to the Return Line connector on the Power Unit.
2. Cut a piece of Tubing to the measured length from the roll of Tubing that comes with the Lift.
It is better to cut the Tubing a little too long rather than a little too short.
3. Route the Tubing from the Hydraulic Cylinder through the Flex Tube opening, and out next to where the Power Unit will be installed.
Let the Tubing hang out of the opening for now.
4. Remove the Shipping Plug from the Return Line Connector on the Hydraulic Cylinder.
5. Connect and tighten the Elbow Compression Fitting into the opening where the Shipping Plug was.
6. Connect one end of the Return Line to the Elbow Compression Fitting you just installed.
Refer to **Working with Compression Fittings and Tubing** for instructions.
7. Leave the Power Unit end of the Return Line hanging out of the Flex Tube opening for now.
It will be connected to the Power Unit later in the installation.



IMPORTANT! PLEASE READ NOW



Hydraulic Fluid Contamination

Hydraulic Fluid Contamination poses a **serious** issue for your Lift; contaminants such as water, dirt, or other debris can get into the Hydraulic Hoses and Fittings on your Lift, making your new Lift inoperable.

Your Lift is shipped with clean components; however, BendPak strongly recommends that you take secondary precaution and clean all Hydraulic Hoses and Fittings prior to making connections. It is better and less costly to take these extra steps now so that you do not need to take your Lift out of service later to fix issues that could have been prevented at the time of installation.

There are several ways to clean Hydraulic Hoses and Fittings:

- **Compressed Air.** Use an air compressor to blow out contaminants from each Hydraulic Hose and Fitting prior to installation. Clean, dry air is preferred. Wear eye protection (safety glasses, goggles, or face shield) when using compressed air for cleaning. Never point an air hose nozzle at any part of your body or any other person.
- **Fluid Flushing.** As long as the Hydraulic Fluid is clean and compatible with the system fluid, you can flush Hoses and Fittings to create turbulent flow and remove particulates. Always ensure that the fluid itself is contaminant-free.

Some additional steps that will help keep the Hydraulic Fluid clean:

- **Remove old thread seal tape.** Some ports on the Hydraulic Cylinders are shipped with temporary plugs secured with thread seal tape, so make sure to thoroughly remove any leftover thread seal tape that may inadvertently enter the Hydraulic System.
- **Use a liquid thread sealant only.** Teflon paste-type thread sealant or Loctite™ 5452 thread sealant is recommended for all NPT Fittings. Do not over tighten NPT Fittings or they may crack. Never use thread seal tape on JIC Fittings or ORB O-Ring Fittings.
- **Always use clean equipment.** If you use a dirty bucket or funnel to transfer the Hydraulic Fluid into the Hydraulic Fluid Reservoir, the contaminants will likely be introduced into the Fluid. When using cleaning rags, use a lint-free rag.
- **Proper storage.** Keep the Hydraulic Fluid sealed in its container until ready for use; store the Fluid in a clean, dry, and cool area.
- **Cover the Hoses and Fittings.** Before installation, do not leave the ends of the Fittings exposed; the same applies for the Hydraulic Hoses. As a general rule, keep the Hydraulic Hoses and Fittings capped and kept clean in a clean area until ready for use.
- **Filter the new Hydraulic Fluid.** Just because it is new does not necessarily mean it is *clean*. Use an offline filtration cart or kidney loop system to make sure the Hydraulic Fluid is clean before being transferred into the Hydraulic Fluid Reservoir (even using a heavy duty nylon mesh screen is better than trusting what is left at the bottom of the barrel).
- **Avoid mixing different types of Hydraulic Fluid.** If Hydraulic Fluid needs to be replaced, make sure to flush the Hydraulic System of the old Hydraulic Fluid before you add the replacement Fluid; do not mix the two together.

About Thread Sealants

We recommend using a Liquid Thread Sealant (like Loctite™ 5452 or similar PTFE Thread Sealant) to seal the Hydraulic components on your Lift.

Liquid Thread Sealant lubricates and fills the gaps between the Fitting threads, and leaves no residue that could contaminate the Hydraulic Fluid. Other types of Thread Sealants (like Teflon Tape) can shred during installation or removal and eventually enter the Hydraulic System.

Thread Sealant is not the same as a Threadlocker, Threadlocker holds assemblies tightly in place to prevent them from loosening over time, and is not easily removed.

Thread Sealant can be used with most Hydraulic Fittings, although you probably only need to use it with NPT connectors.

To apply Thread Sealant:

1. Make sure the Fittings and connectors you are going to use are clean and dry.

If you are adding Thread Sealant to a Fitting or connector that has already been used with a different Sealant, use a wire brush to thoroughly remove the old sealant before adding more.

2. Apply a small amount of Thread Sealant to the first four threads of the Fitting.

 **WARNING** Always wear the proper protective equipment when handling Thread Sealant.

You only need a small amount because the sealant spreads to the other threads as it is tightened into place.

If you put too much, the excess liquid will be pushed out when the Fitting is tightened; use a rag to wipe the excess.

3. Tighten the Fitting into the connector; do **not** over tighten the Fitting.
4. Allow the manufacturer-recommended curing time before pressurizing the system.

Installing the Hydraulic Hose

The Hydraulic Hose moves Hydraulic Fluid from the Power Unit to the Hydraulic Cylinder.

To install the Hydraulic Hose, you will need:

- **The Hydraulic Hose.** The Hydraulic Hose has a Curved end and Straight end.
- **JIC to NPT Hydraulic Fitting.** The JIC end goes to the Hydraulic Hose and the NPT end goes to the Hydraulic Cylinder.
- **JIC to ORB Hydraulic Fitting.** The JIC connector goes to the Hydraulic Hose and the ORB end to the Power Unit.

The following drawing shows the connections to make to the Hydraulic Hose.

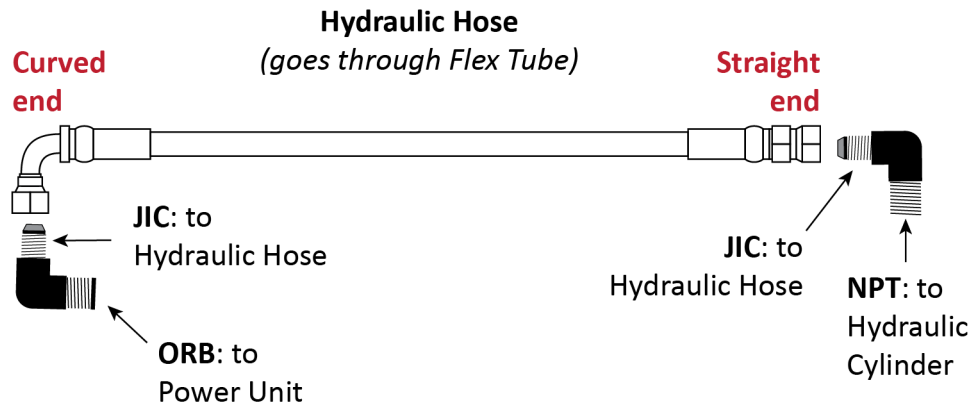

Drawing not to scale. Not all components are shown.

The following procedure is based on the drawing above, but it does not matter which end of the Hydraulic Hose is connected to the Power Unit; choose the option that best fits your setup.

To install the Hydraulic Hose:

1. Find the Hydraulic Hose and a Hydraulic Elbow Fitting (04 JIC – 06 NPT).
2. Clean the Hydraulic components using the information in [Hydraulic Fluid Contamination](#).
3. On the Hydraulic Cylinder, remove the Shipping Plug from the connector at the Piston Rod end.
4. Attach the NPT end of the JIC-to-NPT Fitting to the connector on the Hydraulic Cylinder (where you just removed the Shipping Plug) and tighten it.
5. Attach the Straight end of the Hydraulic Hose to the JIC connector and tighten it.
6. Take the Curved end of the Hydraulic Hose and, starting at the Hydraulic Cylinder, route the Curved end through the Retaining Rings (along inside edge of the Powerside Runway) and the Flex Tube opening.

Once done, the Curved end should be coming out of the Flex Tube opening near the Power Unit.

7. Leave the Curved end of the Hydraulic Hose coming out of the Flex Tube opening for now.

It will be connected to the Power Unit later in the installation.

Installing the Power Unit

This section describes how to **install**, but not make the connections to, the Power Unit for your Lift. An Electrician is **not** needed to install the Power Unit; one is required to connect the Power Unit to its power source.

The Power Unit **must** be installed on the Power Post; attach it to one of the two Mounting Brackets, whichever is more convenient for the installation.

Important: Many people install the Flex Tube Bracket Plate and/or the Zero Angle Bracket at the same time as they install the Power Unit. Read [Installing the Flex Tube](#) and [Installing the Pushbutton Air Valve](#) for more information to see if this makes sense for your installation.

⚠ DANGER Risk of explosion: The Power Unit has internal arcing or parts that may spark and should not be exposed to flammable vapors. Never expose the Power Unit motor to rain or other damp environments. Damage to the motor caused by water is **not** covered by the warranty.



Tip

The Power Unit is heavy. We recommend you have one person hold the Power Unit while another person bolts it in place.

The following drawing shows how to attach the Power Unit to the Power Post.

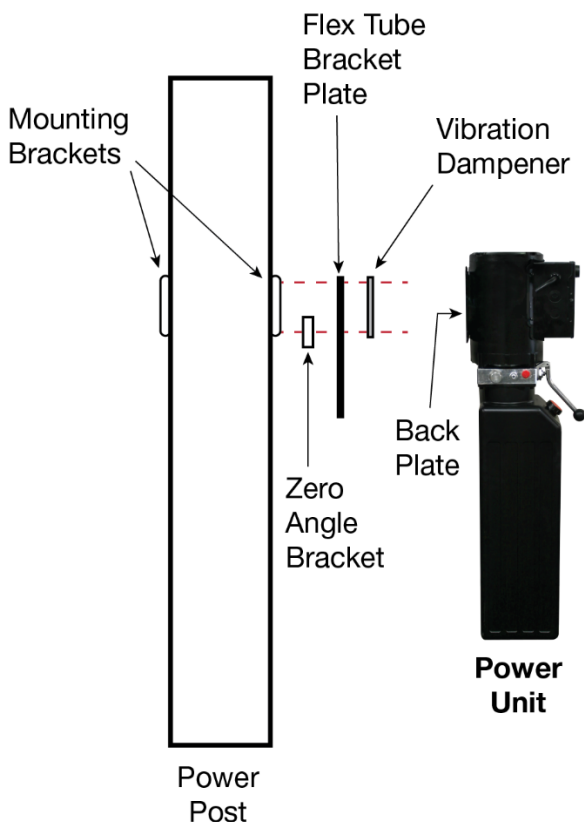

Side view of Power Post. Not drawn to scale. Not all components are shown.

To install the Power Unit:

1. Find the four supplied Hex Head Bolts, Flat Washers, Nyloc Nuts, and Vibration Plate.
2. Line up the holes on the Power Unit Back Plate with the four holes in the Mounting Bracket you want to use.

If you are going to install the Flex Tube Bracket Plate and/or the Zero Angle Bracket at the same time as the Power Unit, now is the time to put those into place.
3. Place a Flat Washer onto each of the four Hex Head Bolts, slide the Bolts through the back of the Mounting Bracket and through the holes in the Vibration Dampener.
4. Have the second person lift the Power Unit and slide the holes in the Back Plate of the Power Unit over the Bolts that are coming out of the Vibration Dampener.
5. Add the Nyloc Nuts to secure the Power Unit in place.

Filling the Hydraulic Fluid Reservoir

The Hydraulic Fluid Reservoir on the Power Unit must be filled with Hydraulic Fluid or automatic transmission fluid before you begin normal operation. When you receive the Lift, the Reservoir is empty.

The Power Unit will not work correctly until it is filled with the approved Hydraulic Fluid.

Approved fluids are any general purpose ISO-32, ISO-46, or ISO-68 Hydraulic Fluid or approved automatic transmission fluids such as Dexron III, Dexron VI, Mercon V, Mercon LV, or any synthetic Multi-Vehicle automatic transmission fluid.

 **WARNING** Do not run your Power Unit without Hydraulic Fluid; you will damage it.

To fill the Hydraulic Fluid Reservoir:

1. Remove the Reservoir Cap and set it aside.

Take care to **keep contaminants out** of the Hydraulic Fluid Reservoir.
2. Fill the Hydraulic Fluid Reservoir on the Power Unit with the appropriate amount of Hydraulic Fluid:
 - **5585280**: 3.6 gallons / 13.5 Liters
 - **5585079**: 3.5 gallons / 13.25 Liters
 - **5585014**: 3.7 gallons / 14 Liters
 - **5585247**: 3.7 gallons / 14 Liters
 - **5585177**: 3.5 gallons / 13.25 Liters
 - **5585178**: 3.5 gallons / 13.25 Liters

Approved fluids are any general purpose ISO-32, ISO-46, or ISO-68 Hydraulic Fluid or approved automatic transmission fluids such as Dexron III, Dexron VI, Mercon V, Mercon LV, or any synthetic Multi-Vehicle automatic transmission fluid.

3. When the Reservoir is filled, replace the Reservoir Cap.

Do not connect the Power Unit to a power source at this point.

Installing the Second End of the Flex Tube

Once the Power Unit is installed, you can install the second end of the Flex Tube (the other end was connected to the Powerside Runway earlier in the installation).

The Flex Tube consolidates and protects the lines that come out from under the Powerside Runway: the Air Line, the Return Line, and the Hydraulic Hose.

To connect the Flex Tube to the Power Unit, you first need to connect the Flex Tube Bracket Plate and the Flex Tube Angle Plate.

Flex Tube Bracket Plate

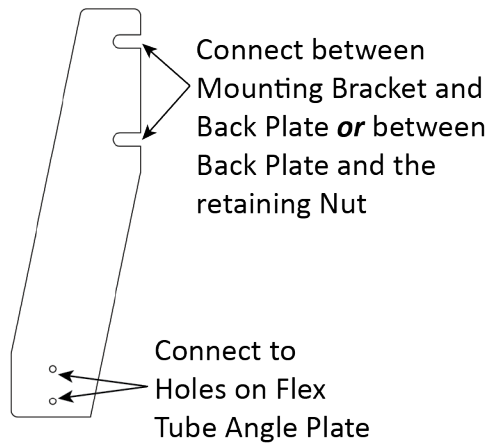

Flex Tube Angle Plate

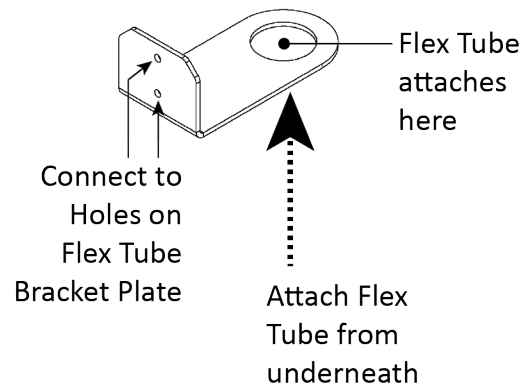

The components involved include:

- **Flex Tube.** Protects the Air Line, the Return Line, and the Hydraulic Hose. One end connects to the hole on the Flex Tube Angle Plate from underneath, the other end connects to the hole on the side of the Powerside Runway.
- **Flex Tube Bracket Plate.** The two notches at the top attach near the Mounting Bracket on the Power Post. The two holes at the bottom connect to the Flex Tube Angle Plate.
- **Flex Tube Angle Plate.** Attaches to the Flex Tube Bracket Plate via two holes, giving you the flexibility to connect it on either side. Includes the hole to which the Flex Tube connects.

BendPak recommends orienting the Flex Tube so that the lines coming out of it are near where it connects on the Power Unit and to the Pushbutton Air Valve.

To connect the Flex Tubes:

1. Find the Flex Tube Bracket Plate and the Flex Tube Angle Plate.
2. Install the Flex Tube Bracket Plate.

Location options are: between the Mounting Bracket and the Back Plate or between the Back Plate and the retaining Nut (see the drawing on the following page).

Note: It is common to install the Flex Tube Bracket Plate between the Mounting Bracket and the Back Plate. This allows the Zero Angle Bracket (which holds the Pushbutton Air Valve and is described in the next section) to be installed between the Back Plate and the retaining Nut. This configuration is common, but not required.

The following drawing describes how to position the Flex Tube Bracket Plate between the Mounting Bracket and Back Plate.

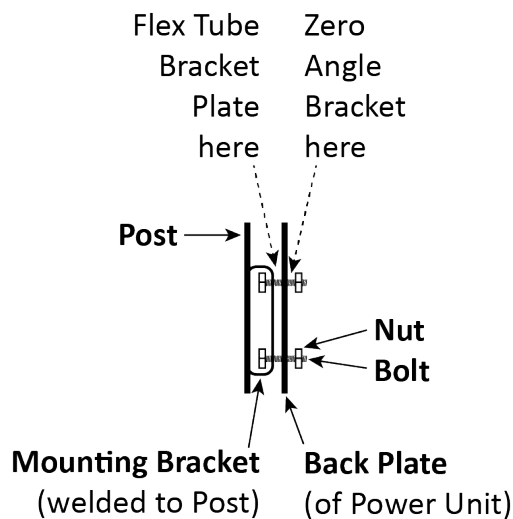

Side view of where the Power Unit attaches to the Power Post. Not necessarily to scale.

3. Connect the Flex Tube Angle Plate to the Flex Tube Bracket Plate so that the holes for the Flex Tubes are best positioned for connecting the Return Line, the Air Line, and the Hydraulic Hose. The Flex Tube Angle Plate can be connected on either side of the Flex Tube Bracket Plate.
4. When the Flex Tube Angle Plate is in place, unscrew the Plastic one of the Flex Tubes.
5. Holding the Flex Tube by the Plastic Collar, put the Threads through the hole on the Flex Tube Angle Plate **from underneath**.
6. Screw the Plastic Nut back onto the Threads and tighten.

Installing the Pushbutton Air Valve

Once the Power Unit and the Flex Tube are installed, you can install the Pushbutton Air Valve, which requires the Zero Angle Bracket (which may already have been installed).

The Pushbutton Air Valve is used to lower the Runways. It can go on either side of the Power Unit, but we recommend placing it on the side facing away from the Lift to be out of the way.

Once the pushbutton is in place, you need to connect it to the Air Line on one end and the customer-supplied air pressure on the other end. **A minimum air pressure of 75 PSI / 3 CFM is required.**

The following drawing shows the Zero Angle Bracket and where it connects.

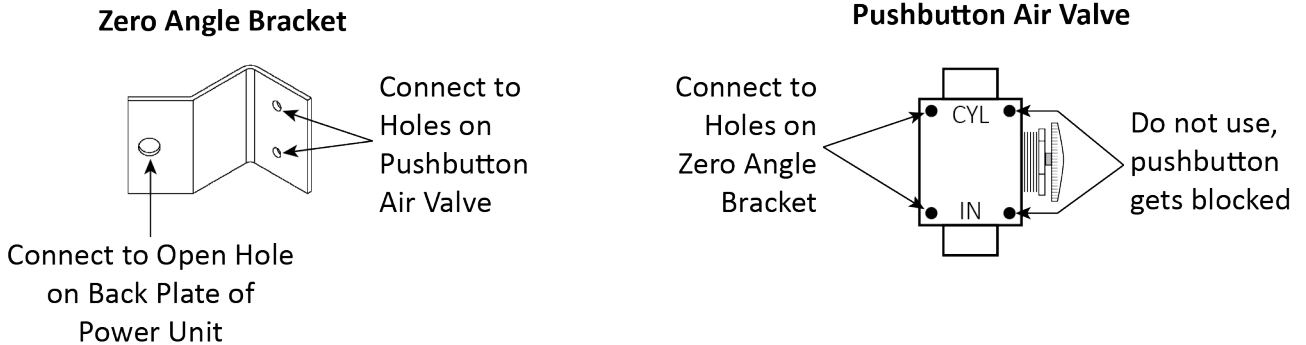

The components involved include:

- **Zero Angle Bracket.** Attaches at the Mounting Bracket on the Power Post or to other available holes on the Back Plate of the Power Unit. Holds the Pushbutton Air Valve, so be sure to orient the Zero Angle Bracket so that the Pushbutton Air Valve can be easily reached by the Lift operator.
- **Pushbutton Air Valve.** Used to lower the Runways.
- **Air Line Compression Elbow Fitting.** Connects the Pushbutton Air Valve to the Air Line coming from the Tee Fitting.
- **Straight Expander Fitting.** Connects the Pushbutton Air Valve to the customer-supplied air pressure.

To install the Pushbutton Air Valve:

1. Find the necessary components: Zero Angle Bracket, Pushbutton Air Valve, Air Line Compression Elbow Fitting, and Straight Expander Fitting.

2. Connect the Zero Angle Bracket at the desired location (if it has not already been connected).

It can attach to an available hole on the Back Plate of the Power Unit or to one of the Bolts that connect the Power Unit to the Mounting Bracket on the Power Post.

The best location is one that is visible and easily reached by the Lift operator.

3. Connect the Pushbutton Air Valve to the Zero Angle Bracket.

Use the two holes on the Pushbutton Air Valve on the side away from the actual pushbutton. If you use the holes next to the pushbutton, the Zero Angle Bracket interferes with the pushbutton when you try to use it.

The following drawing shows the Pushbutton Air Valve and its connections.

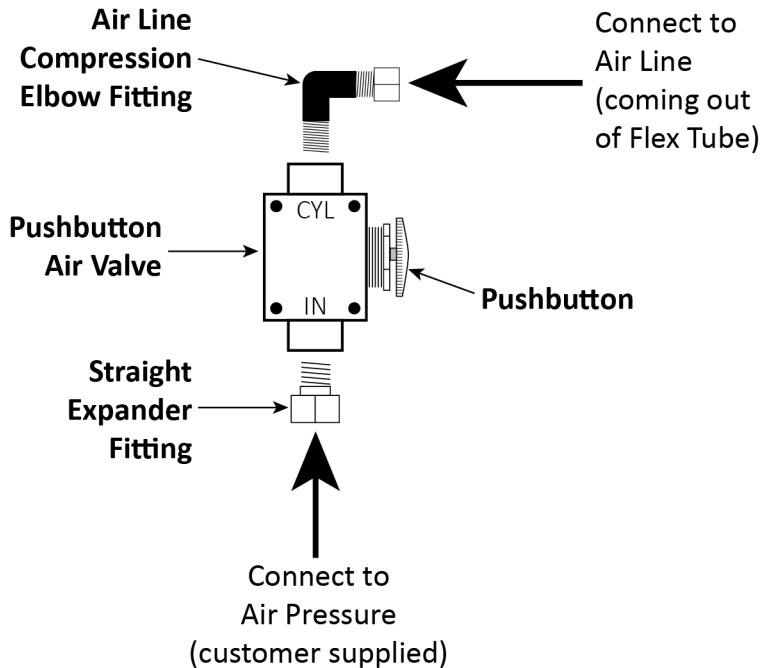

4. Connect the Air Line Compression Elbow Fitting and the Straight Expander Fitting to the appropriate locations on the Pushbutton Air Valve.

The Elbow Fitting connects to the opening labelled **CYL**. The Straight Fitting to the opening labelled **IN**. See the drawing above.

5. Attach the Air Line (coming out of the Flex Tube) to the Compression Fitting on the Elbow Fitting and the customer-supplied air to the Straight Fitting.

Important: The Return Line also comes out of the Flex Tube and is the same kind of tubing as the Air Line. **Do not attach the Return Line to the Pushbutton Air Valve by mistake.** Double check to make sure you are attaching the Air Line to the Pushbutton Air Valve.

For the customer-supplied air pressure, a minimum of 50 to 150 psi / 3 to 25 cfm is required.

Connecting the Return Line

The Return Line should already be routed through the Flex Tube and connected to the Return Line connector on the Hydraulic Cylinder; the other end of the Return Line needs to be connected to the Power Unit.

To attach the Return Line to the Power Unit:

1. Find an Elbow Compression Fitting (04 COMP – 06 NPT) from the Parts Bag.
2. Locate the Hydraulic Return connector on the Power Unit and remove the Shipping Plug.
See **Connecting the Power Source** for the possible connector locations.
3. Connect and tighten the threaded end of the Elbow Compression Fitting to the Hydraulic Return connector on the Power Unit.

For information about connection compression fittings, refer to **Working with Compression Fittings and Tubing**.

4. Find the Return Line coming out of the Flex Tube and connect it to the other connector on the Elbow Compression Fitting.

Important: The Air Line, at one point, was also coming out of the Flex Tube and it uses the same kind of tubing as the Return Line. The Air Line should have been connected in the previous section, but if it was not, make sure you are attaching the Return Line to the Power Unit and not the Air Line. ***Do not attach the Air Line to the Power Unit by mistake.***

Connecting the Hydraulic Hose

The Hydraulic Hose connects to a Hydraulic Power Out connector on the Power Unit; the Curved end of the Hydraulic Hose is already connected to the Hydraulic Cylinder, the other end should be coming out of the Flex Tube.

To connect the Hydraulic Hose:

1. Find the Hydraulic Fitting (04 JIC – 06 ORB). The Hydraulic Hose is already in place, with the Straight end coming out of the Flex Tube.
2. Locate the Hydraulic Power Out connector on the Power Unit you want to use and remove the Shipping Plug.
See **Connecting the Power Source** for the possible connector locations.
3. Connect and securely tighten the ORB end of the JIC – ORB Fitting to the Hydraulic Power Out on the Power Unit.
4. Connect and securely tighten the JIC end of the JIC – ORB Fitting to the Hydraulic Hose coming out of the Flex Tube.

Contacting the Electrician

As mentioned previously, there are installation tasks that **require** a certified Electrician.

⚠ DANGER All wiring **must** be performed by a licensed, certified Electrician. If someone who is not a certified Electrician attempts these tasks, they could damage the Lift or be electrocuted, resulting in serious injury or even death.

The Electrician needs to:

- **Connect a power source to the Power Unit.** A power source is required. The Power Unit comes with a pigtail for wiring to the power source. Have your Electrician remove the pigtail and attach an appropriate Power Cord and Plug or wire directly into the facility's electrical system. Refer to **Connecting the Power Source** for more information.
- **Install a Power Disconnect Switch.** Ensures you can quickly and completely interrupt electrical power to the Lift in the event of an electrical circuit fault, emergency situation, or when equipment is undergoing service or maintenance. You must put it within sight and easy reach of the Lift operator. Refer to **Install a Power Disconnect Switch** for more information.
- **Install a Thermal Disconnect Switch.** Ensures the equipment shuts down in the event of an overload or an overheated motor. Refer to **Install a Thermal Disconnect Switch** for more information. ***The motor on the Power Unit that comes with the Lift is not thermally protected.***

The Electrician is responsible for providing:

- an appropriate power cord and plug for connecting to the power source
- a Power Disconnect Switch
- a Thermal Disconnect Switch

⚠ DANGER Risk of explosion: This equipment has internal arcing or parts that may spark and should not be exposed to flammable vapors. The Power Unit's motor should not be located in a recessed area or below floor level. Never expose the motor to rain or other damp environments; damage to the motor caused by water is **not** covered by the warranty.

Connecting the Power Source

The standard Power Unit for your Lift is 220 VAC, 60 Hz, single phase. The Power Unit must be connected to an appropriate power source.

Refer to **Wiring Diagrams** for wiring information.

⚠ DANGER All wiring **must** be performed by a licensed, certified Electrician. Do not perform any maintenance or installation on the Lift without first making sure that main electrical power has been disconnected from the Lift and **cannot** be re-energized until all procedures are complete. If your organization has Lockout/Tagout policies, make sure to implement them after connecting to a power source.

Important electrical information:

- Improper electrical installation can damage the motor; this is not covered under warranty.
- Use a separate circuit breaker for each Power Unit.
- Protect each circuit with a time-delay fuse or circuit breaker. For a 220 VAC, single phase circuit, use a 25 amp or greater fuse.

The Hydraulic Power Ports are usually labeled **P1/P2** on the Power Unit; the Hydraulic Return Ports are commonly labeled **T1/T2** or **CV1/CV2**.

The following drawing shows the standard configuration for the Power Unit.

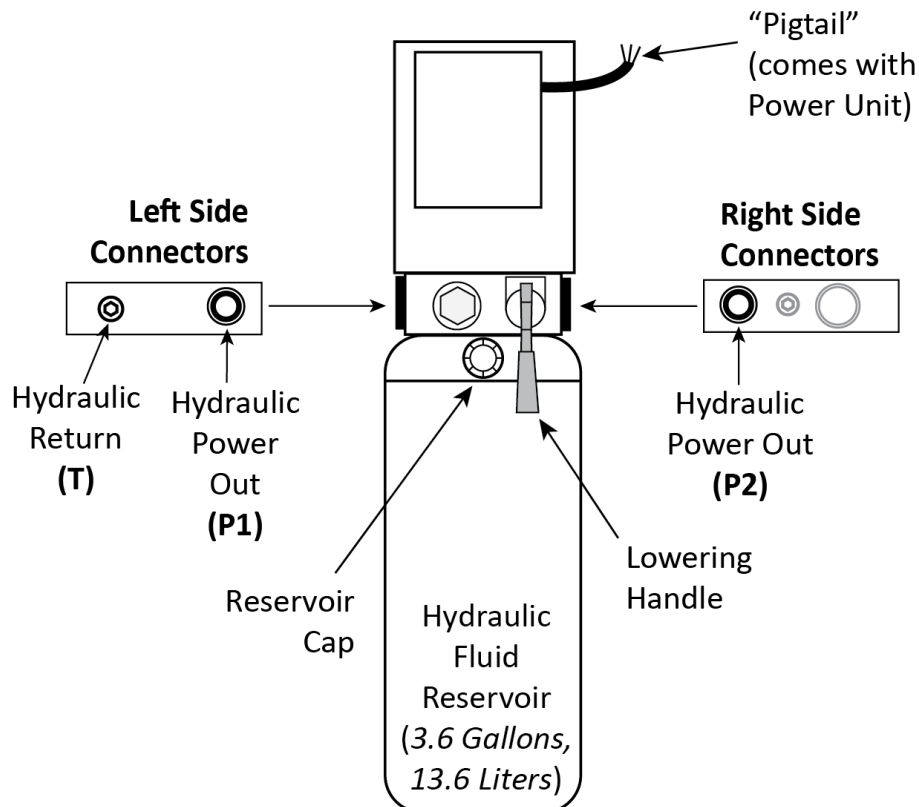

Not drawn to scale. Not all components shown.

The following drawing shows the possible connector locations, depending on the Power Unit you may have.

Left Side Connectors

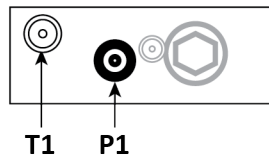
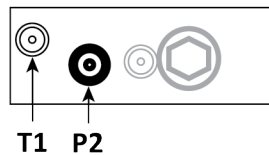
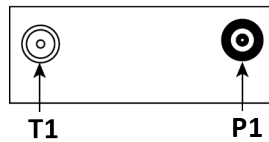

Front

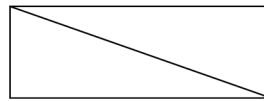
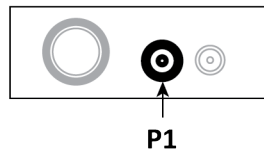
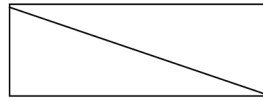

Right Side Connectors

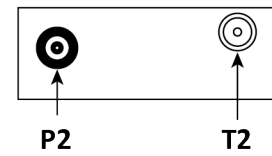
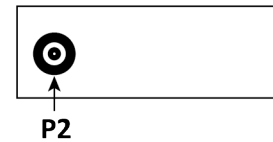

Not drawn to scale. Not all components shown.

To connect the Lift to a power source:

1. Have a certified, licensed Electrician locate the Pigtail coming out of the Electrical Box on the Power Unit.
2. Open the Electrical Box, remove the Pigtail, and then either:
 - Wire the Power Unit directly into the facility's electrical system.
 - Wire a Power Cord (with appropriate plug) inside the Electrical Box to the wiring that was connected to the Pigtail.

The Power Cord and Plug are **not** supplied with the Lift.

See [Wiring Diagrams](#) for more information.

Installing a Power Disconnect Switch

⚠ WARNING A main Power Disconnect Switch is **not** provided with this equipment.

A Power Disconnect Switch is a National Electrical Code (NEC) requirement. They are designed to interrupt electrical power in the event of an electrical circuit fault, emergency situation, or when equipment is undergoing service or maintenance.

BendPak strongly recommends that you install a Power Disconnect Switch that is properly rated for the incoming power.

⚠ DANGER All wiring **must** be performed by a licensed, certified Electrician.

Your Power Disconnect Switch must be readily accessible and installed so that it is in easy reach of the Lift operator. It must be clearly and legibly marked to indicate its purpose.

The drawing to the right shows a toggle Power Disconnect Switch between the Lift's power source and its Power Unit. A quick flip of the switch immediately cuts power to the Lift.

Make sure to have a certified Electrician install the Power Disconnect Switch.

Make sure the electrician selects a **UL-listed** Power Disconnect Switch.

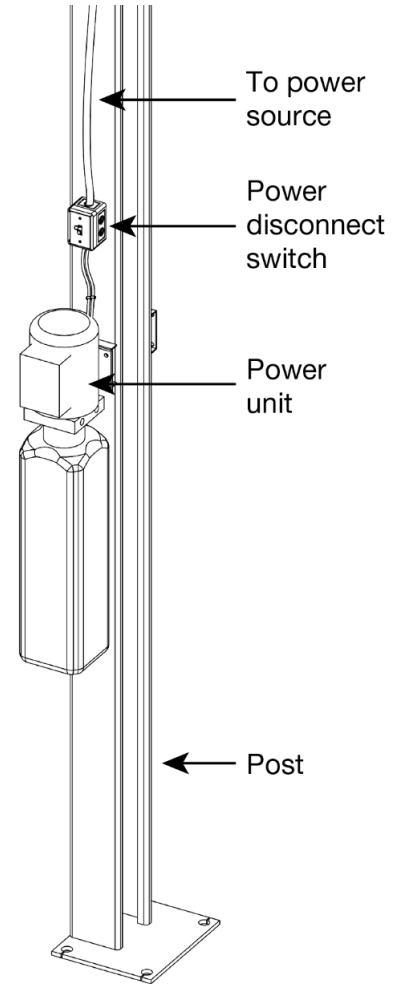

Installing a Thermal Disconnect Switch

⚠ WARNING The Lift's motor does **not** have thermal overload protection.

Connect a motor Thermal Disconnect Switch or overload device that will make sure the equipment shuts down in the event of an overload or an overheated motor.

⚠ DANGER All wiring **must** be performed by a licensed, certified Electrician.

High running amps that exceed the motor's full load amps (FLA) rating may result in permanent damage to the motor.

BendPak strongly recommends you **not** exceed the rated duty cycle of the Lift's motor.

About Effective Embedment

Anchor Bolts (also called Wedge Anchors) get their holding strength from how far down into the Hole the Anchor Bolt's Expansion Sleeve presses into the Concrete (called Effective Embedment) and how forcefully the Expansion Sleeve presses into the Concrete (based on the width of the hole and how much Torque is applied).

The further down into the Hole you get the Expansion Sleeve, the greater the Effective Embedment and thus the greater the holding strength of the Anchor Bolt. The hole should be drilled the same width as the Anchor Bolt with no wobbling. The correct amount of Torque is a range; too little Torque and the Anchor Bolts hold with less strength, too much Torque and you could damage the Concrete and lessen the Anchor Bolt's holding strength.

Note: Some people confuse Effective Embedment with *Nominal* Embedment, which is how far down into the Hole the *bottom* of the Anchor Bolt is. The two are **not** the same; Nominal Embedment does not tell you anything about the holding strength of the Anchor Bolt.

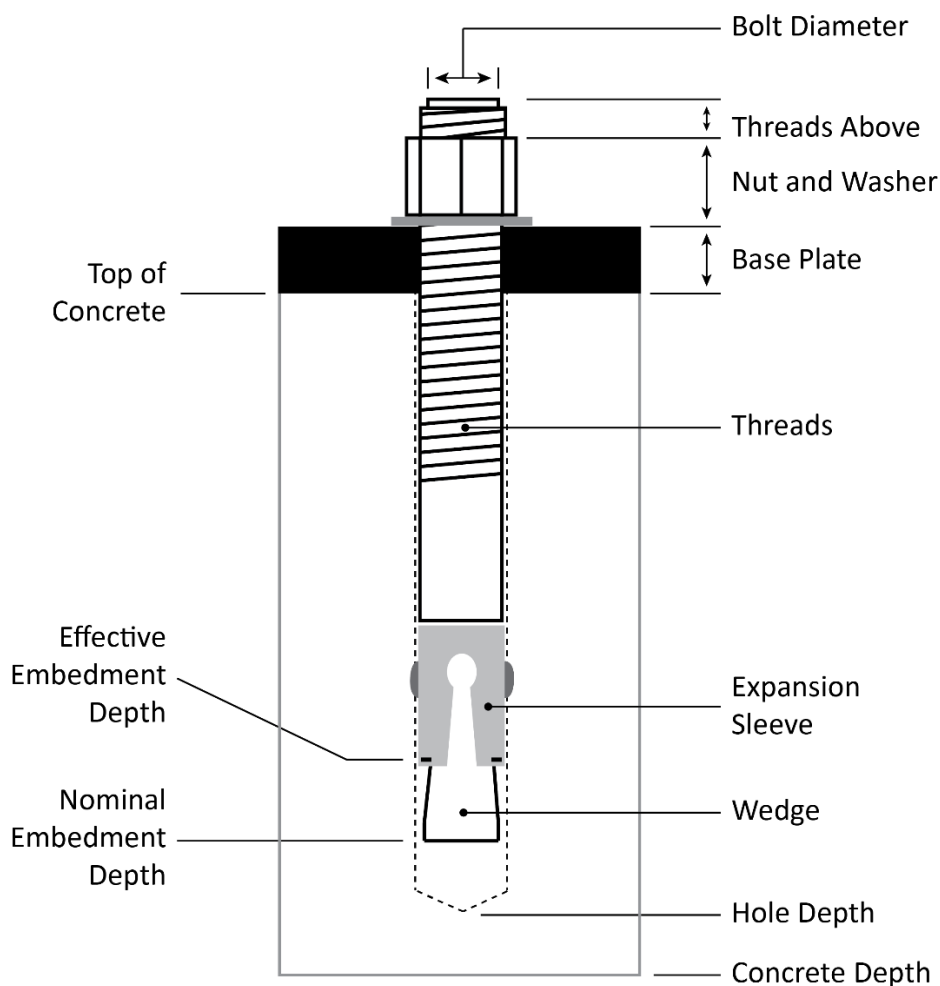

Make sure to carefully follow the specifications and instructions in the following procedure.

⚠ WARNING

Use only the Anchor Bolts that came with your Lift. Only install your Lift on a Concrete floor. Make sure to get the correct amount of Effective Embedment and use the correct amount of Torque.

Anchoring the Posts

Install one Anchor Bolt in each corner of each Base Plate, 4 per Post, 16 Anchor Bolts total.

Concrete specifications are:

- **Depth:** 4.25 inches
- **PSI:** 3,000 PSI, minimum
- **Cured:** 28 days, minimum

Anchor Bolt specifications are:

- **Length:** 4.75 inches
- **Diameter:** .75 inch
- **Anchor torque:** 85-95 pound feet (do *not* Torque less than 80 or more than 105)

⚠ WARNING Your Concrete and Anchor Bolts **must** meet these specifications. Only install your Lift on a Concrete surface. If you install a Lift on asphalt or any other surface, or your Concrete or Anchor Bolts do not meet these specifications, it could lead to product damage, Vehicle damage, personal injury, or even death.

BendPak Lifts are supplied with installation instructions and concrete fasteners meeting the criteria as prescribed by the American National Standard “Automotive Lifts – Safety Requirements for Construction, Testing, and Validation” ANSI/ALI ALCTV.

⚠ WARNING Use only the Anchor Bolts that came with your Lift. If you use components from a different source, you void your warranty and compromise the safety of everyone who installs or operates the Lift.

Lift buyers are responsible for conforming to all regional, structural, and seismic anchoring requirements specified by any other agencies and/or codes, such as the Uniform Building Code and/or International Building Code.

To anchor the Posts:

1. Locate the hardware you will need: four Anchor Bolts, four Nuts, and four washers **per Post**.
2. Using the Base Plates as guides, drill the holes —one hole in each corner of the Base Plate, so four holes total per Base Plate.

Important: Do **not** drill all the way through the concrete; if you punch completely through the slab, you compromise the holding strength of the Anchor Bolt once put into place.

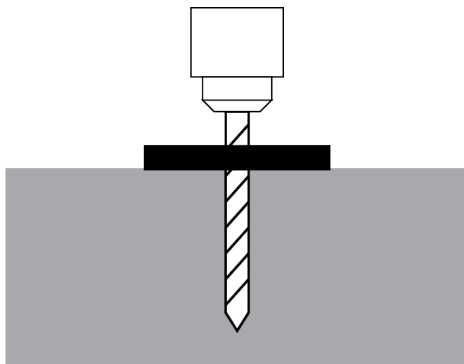

Go in straight, in the center of the hole; do not let the drill wobble.

Use a carbide bit (conforming to ANSI B212.15).

The diameter of the drill bit must be the same as the diameter of the Anchor Bolt. So if you are using a 3/4 inch diameter Anchor Bolt, for example, use a 3/4 inch diameter drill bit.

3. Vacuum each hole clean.

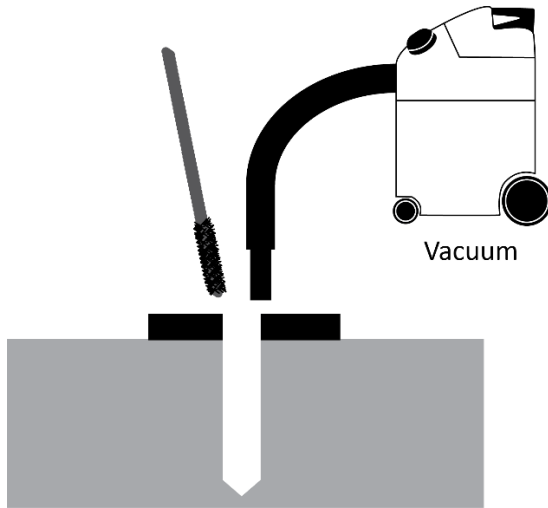

BendPak recommends using a vacuum to clean the hole. You can also use a wire brush, hand pump, or compressed air; just ***make sure to thoroughly clean each hole.***

Do not ream the hole. Do not make the hole any wider than the drill bit made it.

- Important:** The holding strength of an Anchor Bolt is partially based on the how cleanly the Expansion Sleeve presses against the Concrete. If the hole is dirty, the Expansion Sleeve does not press as cleanly, which means less holding strength. If the hole is too wide, the Expansion Sleeve does not press against the Concrete with as much force, again resulting in less holding strength.

4. Make sure the Washer and Nut are in place, ***with the top of the Nut flush with the top of the Anchor Bolt***, then insert the Anchor Bolt into the hole.

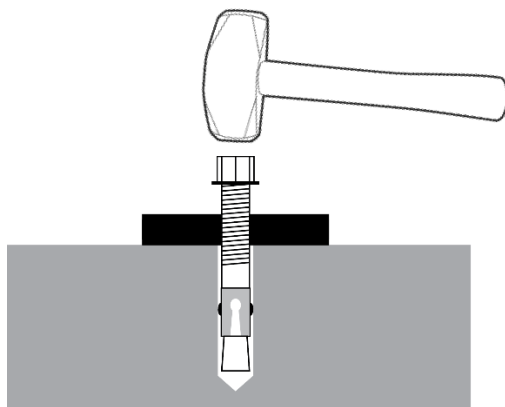

5. Hammer or mallet the Anchor Bolt down into the hole.

The Expansion Sleeve of the Anchor Bolt may prevent the Anchor Bolt from passing through the hole in the Base Plate; this is normal. The hammer or mallet will get the Expansion Sleeve through the Base Plate and into the hole.

Even using a hammer or mallet, the Anchor Bolt should only go into the hole part of the way; this is normal. If the Anchor Bolt goes all the way in with little or no resistance, the hole is too wide.

Once past the hole in the Base Plate, the Anchor Bolt eventually stops going down into the hole as the Expansion Sleeve contacts the sides of the hole; this is normal.

6. Hammer or mallet the Anchor Bolt the rest of the way down into the hole.

Stop when the Washer is snug against the Base Plate.

7. Plumb each Post; install any needed Shims.

Do not shim a Post more than half an inch using the provided Shims. A maximum of 2 inches is possible by ordering optional Shim Plates. Contact BendPak at **(800) 253-2363**, extension 191 to order. Please have the model and serial number of your Lift available.

Take your time while plumbing and shimming the Posts; ***it is important to make the Lift level as possible.***

8. Wrench each Nut ***clockwise*** to the recommended installation torque, 85-95 pound feet, using a Torque Wrench.

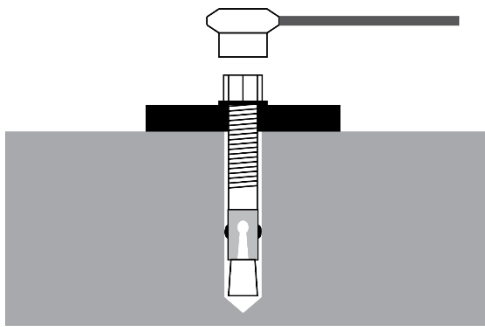

Important: Do ***not*** use an impact wrench to torque the Anchor Bolts.

Wrenching the Nut forces the Wedge up, forcing out the Expansion Sleeve and pressing it tightly against the Concrete.

Final Leveling

The following procedure describes how to fine tune how level your Lift is. The goal is that the four Safety Locks engage at the same time.

To do final leveling on the Lift:

1. Raise the Runways to the first Lock position (the primary Safety Locks, not the Slack Safety Locks).
2. Use a transit level or other leveling mechanism to evaluate how level the Posts and Runways are to each other.
3. If you need to adjust a Runway, use the Top Nut and Stop Nut on the Top Cap of each Post to make adjustments to the Ladder in that Post (which impacts the levelness of the Runway and when the Safety Locks engage).
4. Raise the Lift to full height, listening as the Safety Locks engage.

If the Safety Locks are engaging at the same time, no further adjustments are necessary.

If the Safety Locks are *not* engaging at the same time, check the leveling, make necessary adjustments, and then raise the Lift again and listen as the Safety Locks engage.

5. When you are satisfied the Lift is level, firmly secure the Nuts at the top of each Post.

Installing Accessories

The accessories available for your Lift include:

- **Tire Stops.** Installed at the Front of the Lift. Hold the front Tires of the Vehicle in position.
- **Drive-up Ramps.** Installed at the Rear of the Lift. Allow Vehicles to be easily driven onto the Runways.
- **Caster Kit.** Gets your Lift up off the ground so you can move it. *Optional.*

Tire Stops

Tire Stops go at the Front of the Lift; they prevent the Tires of your Vehicle from going too forward.

To install the Tire Stops:

1. Find the two Tire Stops, Pins, and Rotor Clips needed.
2. Put one Tire Stop in position in between the Tubes on the front of the Runway, then put the Pin through the Tire Stop and the Tubes.
3. Secure the Tire Stop with a Rotor Clip on either end of the Pin.
4. Repeat Steps 2 and 3 for the other Tire Stop.

Drive-up Ramps

The Lift uses Drive-up Ramps for Vehicles to be easily driven onto the Runways.

To install the Drive up Ramps:

1. Find the required components: two Ramps, two Ramp Pins, and four Rotor Clips.
2. Put a Ramp into position at the rear of the Runway, with the Ramp Tube aligned between the two tubes attached to the Runway.
3. Slide a Ramp Pin through the three tubes, then put two Rotor Clips on both ends of the Ramp Pin.

Note: The Ramps are heavy and awkward, so you may want to consider having two people install them; one to hold the Ramp, the other to put the components into place.

4. Repeat Steps 2 and 3 for the other Ramp.

Caster Kit

The Caster Kit includes four assemblies, each of which goes under one of the Lift's four Posts. When the Lift is raised by the Caster Kit assemblies, you can move it to the desired location.



For installations on special flooring, you can go to your local hardware store and get non-slip Rubber Pads and size them to fit the bottom of the Base Plates; the Pads will protect against scratches. Use the Caster Kit to raise the Lift and then put the Pads into place.

⚠ WARNING ***Do not use the Caster Kit with a Vehicle on the Runways,*** if the Vehicle falls off, it could cause product damage or severe injury to anyone nearby.

Important: Only put the Caster Kit assemblies into position to move the Lift. When you are done moving the Lift, remove the Caster Kit assemblies.

The following drawings shows the components of the Caster Kit.

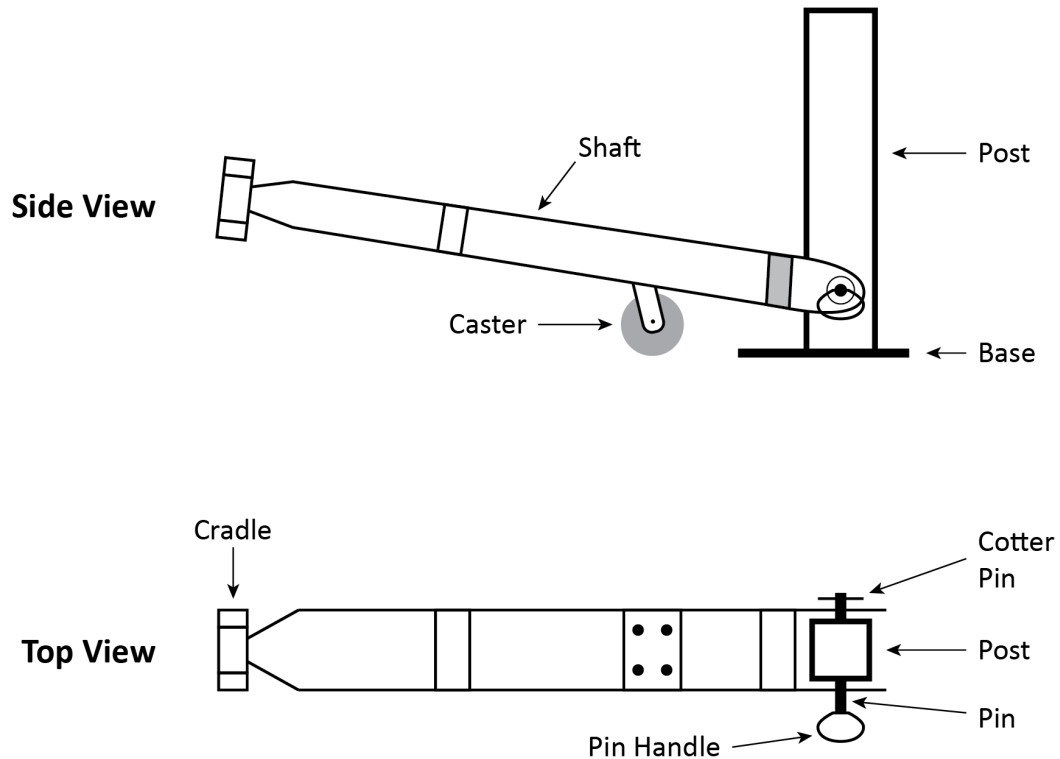

To use the Caster Kit:

1. Raise the Lift to the first Safety Lock and engage it here.
2. Locate the components of the four Caster Kit assemblies.
3. Using the supplied hardware, bolt the four Casters to the four holes in the four Caster Kit Shafts.
4. Take one Shaft and put the open end around the Post, with the Shaft on the inside of the Lift.
The Cradle of the Shaft needs to be directly below the Crosstube.
5. Put the Pin through the holes in the Caster Kit assembly and the Post.
6. Put the Cotter Pin into place on the end of the Pin.
7. Repeat Steps 4 through 6 for the other three Caster Kit assemblies.
8. Lower the Lift to the ground.

Make sure the Crosstubes are going into all four Cradles on all four Caster Kit Shafts; this what pushes the Bases of the Posts off the ground so that you can move it.

9. Move the Lift to the desired location.
10. Raise the Lift to a locking position and engage it there.

⚠ WARNING Make sure the Runways are secured on a Safety Lock position before removing the Caster Kit assemblies.

11. Take off all four Caster Kit assemblies.

Lubricating the Lift

There are several lubrication points on the Lift. All of them are where Sheaves are located:

- **Inside of the Crosstube Gussets.** One on each side of the Crosstube Gusset facing the inside, for a total of eight.
- **Under the Cable Sheaves.** One under each Double Cable Sheave under the Front Powerside Runway and another two under the two Rear Sheaves under the Rear Powerside Runway.

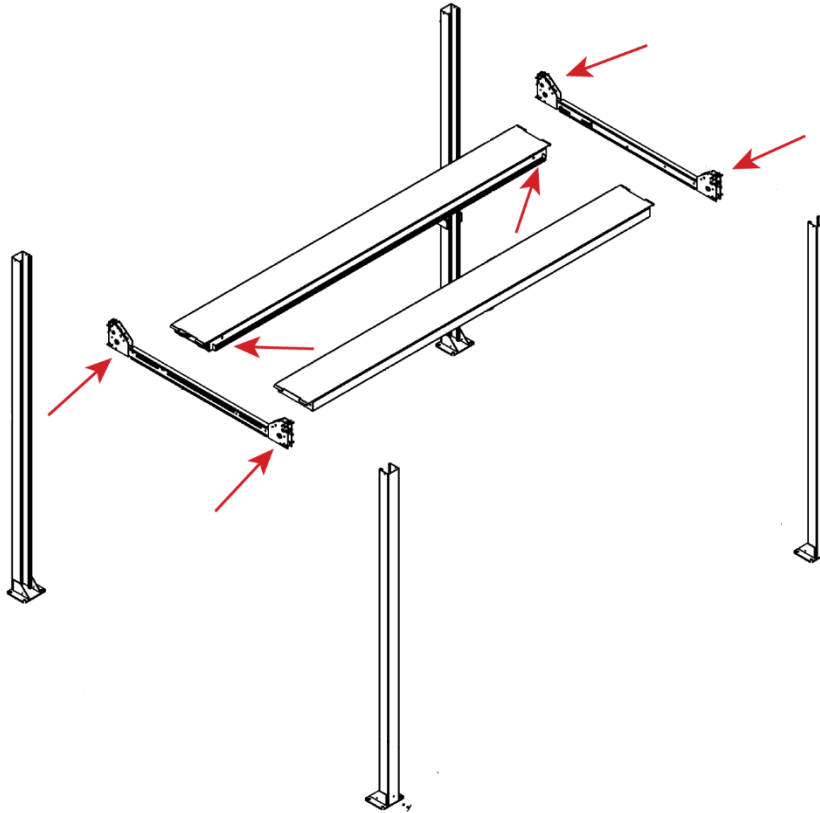

Put a small amount of white lithium grease or similar on each lubrication point before you use the Lift and monthly after putting the Lift into service.

Bleeding the Hydraulic Cylinder

The Hydraulic Cylinder on the Lift is self-bleeding, which means that in most cases any air in the system can be removed by raising and lowering the Runways a few times, “bleeding” the Hydraulic System of the unwanted air.

 **WARNING** Before performing any maintenance on your Lift (for example, bleeding the Hydraulic Cylinder or adding Hydraulic Fluid), make sure the Runways are fully lowered and the power source has been completely disconnected. If your organization has Lockout/Tagout policies, make sure to implement them after connecting to the power source.

Symptoms of air in the Hydraulic System include Runways moving erratically and/or making odd noises. These could be caused by other situations; refer to **Troubleshooting** for more information.

To bleed the Hydraulic System:

1. Raise and lower the Runways up to six times; ***pause for at least one minute between each cycle.***

The Lift’s motor cannot run continuously; it is designed for regular use, but not continuous use.

2. Watch the Runways as you raise and lower them.

When the Lift stops moving erratically or stops squeaking, you can stop the bleeding process.

3. Check the Hydraulic Fluid Reservoir on the Power Unit.

Bleeding the Hydraulic System may significantly lower the amount of Hydraulic Fluid in the reservoir; add more Hydraulic Fluid if necessary.

You can damage your motor by running it without enough Hydraulic Fluid in the reservoir.

If your Lift is still moving erratically or making odd noises after bleeding the Hydraulic System, refer to **Troubleshooting** for more information.

Test the Lift

BendPak strongly recommends doing an Operational Test of your Lift with a standard Vehicle on the Runways before starting normal service (a typical Vehicle is not required, but is recommended).

During the Operational Test, watch the Lift and its components and check for proper installation and operation. If you run into an issue that does not go away, refer to **Troubleshooting**.

Note: Residual air in the Hydraulic Systems can cause the Lift to shake, move erratically, or squeak when you start using it; this is normal. If it happens, do not worry; it will go away as the Hydraulic System is self-bleeding. If it does not go away soon, try bleeding the Cylinder of air. If it still does not go away, refer to **Troubleshooting** for additional information.

To test your Lift:

1. Before you start using your Lift, make sure to check for people, pets, or objects that might be in the path of the Lift as you raise and lower it.
2. Drive the Vehicle onto the Runways; try to center the Vehicle's Tires in the middle of each Runway. Put the Vehicle into park, put on the parking brake, put it in gear if it is a manual transmission, and chock the wheels.
3. Press and hold the **Up** button.
4. After the Runways pass three or four Safety Locks (you will hear them), release the **Up** button.
5. Press and hold the pushbutton on the Pushbutton Air Valve, then press and hold the Lowering Handle.

The Runways back down onto the Safety Locks they just passed.

 **CAUTION** *Never leave the Lift without making sure that all four Safety Locks have engaged on locking positions at the same height.* If one of the four Safety Locks do not fully engage, the Runways will not be level and you could risk damaging any Vehicles sitting on or underneath the Runways.

6. Press the **Up** button for a few seconds to disengage the Runways from the Safety Locks, then release the **Up** button.
7. Press and hold the pushbutton on the Pushbutton Air Valve, then press and hold the Lowering Handle.
8. When the Runways reach the ground, release the Lowering Handle.
9. Wait for one minute.

 **CAUTION** Always take a break between cycles. The Power Unit's motor is **not** constant duty; it cannot be run continuously.

10. Repeat the process, this time raising the Runways to a higher Safety Lock.
11. If the Lift is working without shaking, moving erratically, or squeaking, there is no need to repeat the procedure.

If the Lift is shaking, moving erratically, or squeaking (which is normal during the start-up period), repeat the procedure a couple more times, with at least a one-minute break between cycles.

If you continue to have issues, refer to **Troubleshooting** for assistance.

Final Checklist

Make sure these things have been done **before** putting the Lift into service:

- Review the **Installation Checklist** to make sure all steps have been performed.
- Make sure the Power Unit is getting power from the power source.
- Check the Hydraulic Fluid Reservoir on the Power Unit; it must be full of approved Hydraulic Fluid or automatic transmission fluid. **You can damage the motor by running it without enough fluid.**
- Check the Hydraulic System for leaks.
- Make sure all four Posts are properly anchored, shimmed, level, and stable.
- Make sure all Cables are properly seated in their Sheaves.
- Make sure all Safety Locks are operating normally.
- Make sure the backup Slack Safety Locks are **not** engaged.
- Make sure a copy of the *Installation and Operation Manual* is left with the Lift.
- If it has not been done already, perform an Operational Test of the Lift with a typical Vehicle. Refer to **Test the Lift**.

Outdoor usage

Your Lift is designed for indoor use, but if you decide to use it *outside*, here's what you should know:

- **You may void your warranty.** Damages to the Motor or rusted components on the Lift caused by outdoor elements are not covered by warranty.
- **Cover the Lift.** Use a canopy or something similar to block the Lift from the sun and any precipitation, reducing the impact from it being outside.
- **Protect the Power Unit. This one is really important.** The Power Unit has an electric motor, so if that motor gets wets, it is possible for someone to get electrocuted, a fire can start, and most certainly the motor will short circuit and stop functioning. These things are not covered by the warranty. Always keep the Power Unit and all wiring covered, clean, and dry.
- **Increase the Maintenance.** Placing your Lift outside subjects it to the outdoor elements like wind, rain, dust, sunlight, snow, and other corrosive elements; you will need to double the maintenance on your Lift to minimize the impact from it being outside. For example, if the maintenance suggests doing something weekly, then do it 2-3 times a week.
- **Increase the Replacement Parts.** Everything on the Lift breaks down faster if the Lift is outside, so be prepared to order replacement parts much sooner than with indoor Lifts.

Operation

This section describes how to operate your Lift.

Safety Considerations

Do the following every time **before** you raise a Vehicle on your Lift:

- **Check the Lift.** Walk all the way around the Lift, checking for any missing, heavily worn, or damaged parts. Do not operate the Lift if you find any issues; instead, take it out of service, then contact your dealer, email techsupport@bendpak.com, or call **(800) 253-2363**.
- **Check the area.** Keep the area around and under the Lift clean and free of obstructions; anything that could cause a problem. Do not forget to check **above** the Lift. If you find an obstruction, move it out of the way. If you find any other issues, resolve them before using the Lift. Do not allow any people or animals within 30 feet of the Lift while it is in motion.
- **Check the operators.** Make sure everyone who is going to operate the Lift has been trained in its use, has read the labels on the unit, and has read the manual. Only the operator at the Controls should be within 10 feet of the Lift when it is in motion.

Do not allow children to operate the Lift. Do not allow anyone under the influence of drugs, alcohol, or medication to operate the Lift. Do not allow any unauthorized personnel to operate the Lift.

- **Check for safety.** Make sure everyone who is going to be walking near the Lift is aware of its presence and takes appropriate safety measures. Only put Vehicles on the Runways.

When raising a Vehicle, do not leave it until the Platform is engaged on a Safety Lock. When lowering the Lift, do not leave it until it is on the ground.

- **Check the Vehicle.** Never exceed the Lift's weight rating. Do not allow people inside a Vehicle you are going to raise. Double check you have everything you need out of the Vehicle before raising the Lift. Make sure the Vehicle is not overbalanced on either end or either side.

Using the Controls

The Controls for your Lift include:

- **Up button.** Press and hold to raise the Runways. Located near the top of the Power Unit.

To put Runways onto a Safety Lock position. Raise the Runways a little above where you want them, then press and hold the Lowering Handle to back the Runways down onto the Safety Locks position (do not press and hold the pushbutton on the Pushbutton Air Valve). When the Runways stop going down, they are engaged on a Safety Lock.

Before leaving the Lift, make sure all four corners are engaged on their Safety Locks.

- **Lowering Handle.** Press and hold to lower the Runways. Located in the middle of the Power Unit, the Lowering Handle is long and has a ball at the end.

To lower raised Runways down to the ground: press and hold the Pushbutton on the Pushbutton Air Valve first, then **press and hold** the Lowering Handle.

Watch the Runways as they go down to make sure they are coming down evenly. If they are not, stop lowering the Lift and troubleshoot the problem.

⚠ WARNING Only leave the Runways either engaged on a Safety Lock position or fully lowered.

- **Pushbutton Air Valve.** Press and hold the Pushbutton on the Pushbutton Air Valve as part of the process to lower the Runways. Located on one side or the other of the Power Unit (depending on where it was installed). Pressing and holding the Pushbutton on the Pushbutton Air Valve disengages the Safety Locks, which is needed to lower the Runways.

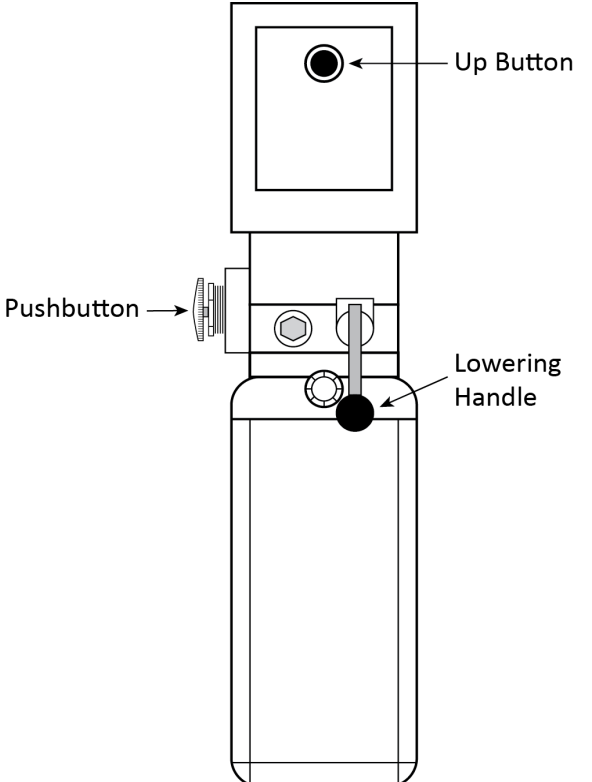
<p>To raise Runways to a Safety Lock:</p> <ol style="list-style-type: none">1. Press and hold Up Button.2. When just past desired height, release Up Button.3. Press and hold Lowering Handle.4. Runways stop going down when engaged on a Safety Lock; release Lowering Handle when they stop. <p><i>Do not press and hold Pushbutton.</i></p>	 <p>The diagram shows a vertical control panel. At the top is a square button labeled 'Up Button'. Below it is a cylindrical component labeled 'Pushbutton'. At the bottom is a long, vertical handle with a ball at the end, labeled 'Lowering Handle'.</p>	<p>To lower Runways:</p> <ol style="list-style-type: none">1. Press the Up Button for a second or two. This disengages the Runways from the Safety Locks.2. Press and hold Pushbutton <i>and</i> Lowering Handle <i>at the same time</i>. Runways begin lowering.3. When Runways are fully lowered, release Pushbutton and Lowering Handle.4. Drive Vehicle off Runways.
---	--	--

Raising and Lowering Vehicles

Keep the following in mind when operating your Lift:

- **Be safe.** Make sure to check for people, pets, and objects that might be in the path of the Lift as you raise or lower it. If there is something in the way, stop the Lift and move it out of the way. Watch the Lift carefully as it raises and lowers.

 **DANGER** Pay careful attention when you are raising or lowering your Lift. If a person or pet gets stuck under the Lift, they could be injured or, in rare cases, killed.

- **The Power Disconnect Switch exists for a reason.** We hope you never have to use it, but if something unexpected happens, use the **Power Disconnect Switch** to immediately stop the Lift from moving.
- **Get what you need out of the Vehicle before lifting it.** It is frustrating to raise a Vehicle and then realize you left something inside. ***Never raise your Lift with people in the Vehicle.***
- **Make sure the Vehicle is balanced.** If there is extra weight on one end or the other, remove it or balance it before raising the Vehicle.
- **Center the Vehicle's wheels on the Runway.** Centered wheels keep the Vehicle balanced.

To raise a Vehicle:

1. Make sure the Runways are on the ground. If they are not, move them to the ground.
2. Drive the Vehicle onto the Runways.

Make sure all four Wheels are fully on the Runways, as close to the center of the Runways as possible.

Put the Vehicle into park and put on the parking brake. If your Vehicle has a manual transmission, place the transmission in first gear, not in neutral.

Chock the Tires.

3. Walk around the Lift to make sure no obstructions will interfere with the Vehicle being lifted.
4. Press and hold the **Up** button.
5. When the Runways get to the desired locking position, go up a little bit more, then release the **Up** button and ***Press and hold*** the Lowering Handle.

The Runways engage on the most recently passed Safety Locks.

How do you know if one of the four Safety Locks, has for some reason, not engaged? If this happens, the non-engaged corner of the Lift will continue to go down, while the others stay where they are. This results in a Runway that is not flat.

Always check to make sure that all four Safety Locks are engaged at the same height before working under or near the raised Vehicle.

 **WARNING** Only leave your Lift either engaged on Safety Locks or fully lowered.

6. With the Runways engaged on the Safety Locks, check around the Vehicle to make sure everything looks good.

If you see anything wrong, fix it before anyone gets near the Runways or goes under them.

To lower a Vehicle:

1. Double check that no one except the Lift operator is within 10 feet of the Lift.
2. Press the **Up** button to disengage the Runways from the Safety Locks.
After a second or two, release the **Up** button.
3. Press and hold the Pushbutton Air Valve **and** the Lowering Handle *at the same time*.
4. Lower the Runways all the way to the ground, then release the Pushbutton Air Valve and the Lowering Handle.
5. Remove the Tire Chocks, then carefully drive the Vehicle off the Runways.

Maintenance

 **DANGER** Before performing any maintenance on your Lift, make sure it is **completely** disconnected from power. If your organization has Lockout/Tagout policies, make sure to implement those procedures after connecting to the power source.

To maintain your Lift:

- **Daily:** Keep the Lift clean. Wipe up any spills, clean any dirt.
- **Daily:** Make a visual inspection of all moving parts and check for damage or excessive wear. Replace any damaged or worn parts before using the Lift.

 **DANGER** Do not use the Lift if the Cables are damaged or extremely worn. If a Vehicle is raised when you notice the damage or extreme wear, very carefully lower the Vehicle to the ground. When the Lift is on the ground, take it out of service, disconnect it from power, and make arrangements to fix the damage or wear.

- **Daily:** Make sure all Safety Locks are in good operating condition. Do not use your Lift if the Safety Locks are damaged or excessively worn.
- **Monthly:** Check all labels on the Lift. Replace them if they are illegible or missing.
- **Monthly:** Grease all lubrication points on the Lift.
- **Monthly:** Check Hydraulic Fluid levels. Refill if low.
- **Monthly:** Lubricate the wire rope (Cables). Use a wire-rope lubricant such as 90-WT gear oil or ALMASOL® Wire Rope Lubricant.
- **Monthly:** Check cable connections, bolts, and pins for proper mounting and torque.
- **Every two months:** Check all Anchor Bolts to make sure they are properly torqued. If they are loose, tighten them.
- **As needed.** Take the Lift out of service and then replace the Lifting Cables if there are signs of damage or extreme wear.

 **WARNING** Do not operate your Lift if you find maintenance issues; instead, take the Lift out of service, then contact your dealer, visit [bendpak.com/support](https://www.bendpak.com/support), email techsupport@bendpak.com, or call **(800) 253-2363**.

Wire Rope Inspection and Maintenance

Your Lift's Cables, which are wire rope, should be inspected regularly:

- Wire rope should be replaced when there are visible signs of damage or extreme wear. *Do not use the Lift if it has damaged or worn Cables; **take it out of service!***

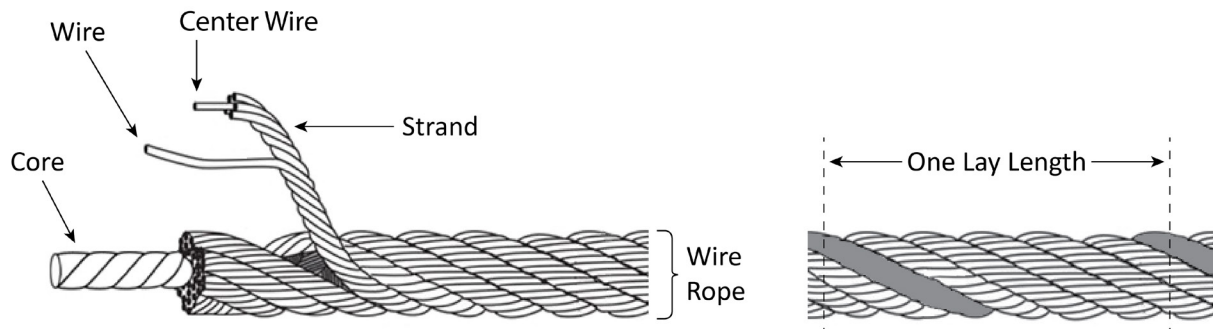

- Wire rope should be maintained in a well-lubricated condition at all times.

Wire rope is only fully protected when each wire strand is lubricated both internally and externally. Excessive wear shortens the life of wire rope. Use a wire-rope lubricant that penetrates to the core of the rope and provides long-term lubrication between each individual strand, such as 90-WT gear oil or ALMASOL® Wire Rope Lubricant. To make sure that the inner layers of the rope remain well lubricated, lubrication should be done at least every three months during normal operation.

- All Sheaves and guide rollers that contact moving wire rope should be given regular visual checks for surface wear and lubricated to make sure they run freely. This should be done every three months during normal operation.

For all sheave axles, use standard wheel bearing grease. For all Sheaves and/or guide rollers, use 90-WT gear oil or a similar heavy lubricant, applied by any method including pump/spray dispensing, brush, hand, or swabbing.

- How often should you inspect?

Wire rope should be visually inspected at least once each day when in use, as suggested by American Petroleum Institute's Recommended Practice 54 guidelines. Any wire rope that meets the criteria for removal must be immediately replaced.

- When should you replace wire rope due to broken wires?

Wire rope should be removed from service if you see six randomly distributed broken wires within any one lay length (where a single strand makes a full turn around the rope) or three broken wires in one strand within one lay length.

- Are there other reasons to replace your wire rope?

Yes. Corrosion that pits the wires and/or connectors, evidence of kinking, crushing, cutting, bird-caging, or a popped core, wear that exceeds 10% of a wire's original diameter, or heat damage.

- How do you find broken wires?

- a. Relax your rope to a stationary position and move the pick-up points off the Sheaves. Clean the surface of the rope with a cloth — a wire brush, if necessary — so you can see any breaks.
- b. Flex the rope to expose any broken wires hidden in the valleys between the strands.
- c. Visually check for any broken wires. One way to check for crown breaks is to run a cloth along the rope to check for possible snags.
- d. With an awl, probe between wires and strands and raise any wires that appear loose.

Troubleshooting

This section describes how to troubleshoot your Lift.

⚠ WARNING If your Lift is **not** functioning correctly, **you must take it out of service until it is fixed**. All repair work must be done by qualified personnel. If your organization has Lockout/Tagout policies, make sure to implement them after connecting to the power source.

Runways do not raise or do not lower, once raised.	<p>Make sure there is sufficient Hydraulic Fluid in the Reservoir.</p> <p>Make sure there is no air in the Hydraulic System.</p> <p>Make sure none of the Hydraulic Hoses are pinched or leaking.</p> <p>Make sure the Power Unit is getting power.</p> <p>If the Hydraulic Fluid is dirty, replace it with clean fluid.</p> <p>Make sure Lift is not overloaded.</p>
Runways do not lower past the nearest Safety Lock even when pressing and holding the pushbutton.	Problem with the Air Lines; check to make sure all sections of the Air Line are connected and not leaking.
One corner of a Platform is lower than the other three corners.	The Safety Lock on the lower corner is not engaged. Raise the Runways up, then lower them down onto the Safety Locks. Check to make sure all four Safety Locks are engaged on Safety Locks of the same height.
Runways move erratically or squeak when in use.	Move the Runways up and down a few times to flush any residual air from the Hydraulic System. Make sure to pause for at least 2 minutes between cycles.
Runways do not stay up.	<p>Check for leaking Hydraulic Fluid.</p> <p>Make sure the Runways are left on their Safety Locks.</p>
Motor not running.	<p>Check the connection to the power source; make sure it is plugged in and of the appropriate voltage.</p> <p>Check the wiring diagram.</p>
Hydraulic Fluid is dirty.	Replace the dirty fluid with clean, approved Hydraulic Fluid.
Runways make odd noises.	Lubricate the Bushings on the Sheaves on the sides of the Crosstubes using white lithium grease. If the Lift is new, a break-in period may be needed; run the Lift several times each day. If the noises persist, contact BendPak Support.

If you continue to have issues with your Lift, take it out of service, then contact your dealer, go to bendpak.com/support, email techsupport@bendpak.com, or call **(800) 253-2363**.

Wiring Diagrams

5585280 (208-230 VAC, single phase)

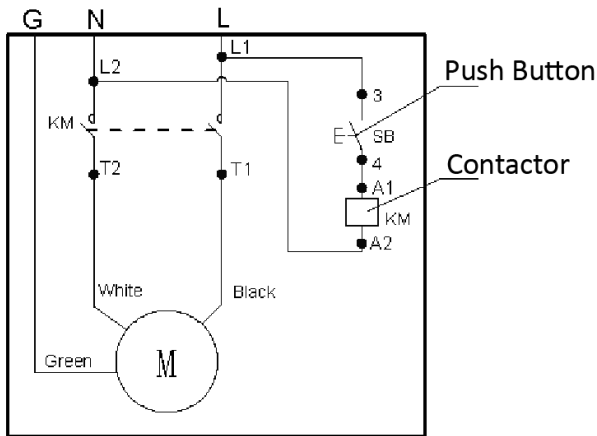

5585079 (208-230 VAC, single phase)

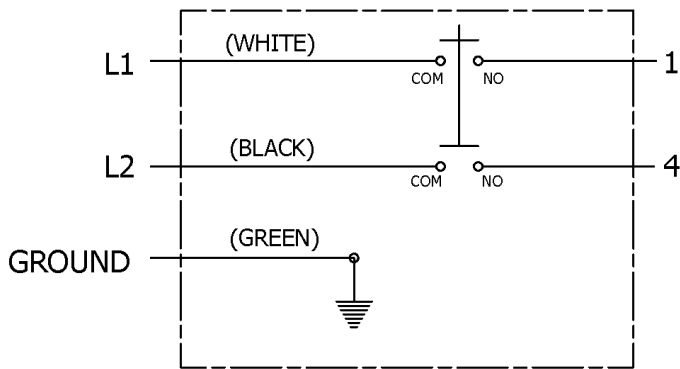

5585178 (110 VAC)

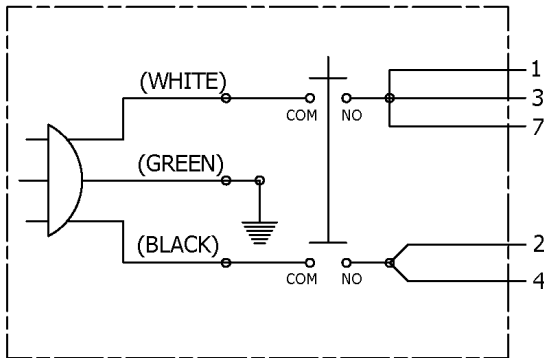

5585014 (110 VAC)

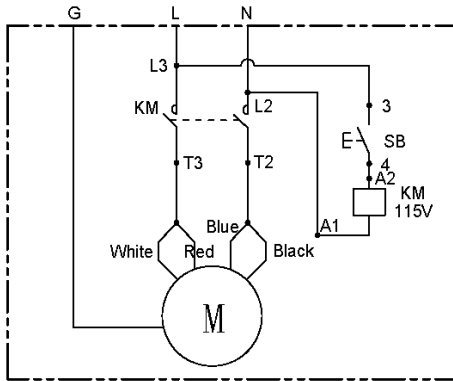

Wiring for 115V

5585177 (Select VAC, three phase)

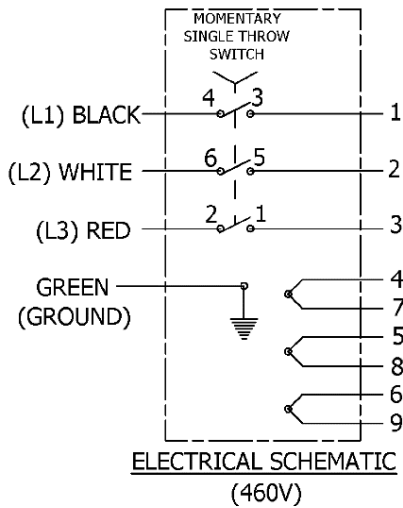

5585247 (Select VAC, three phase)

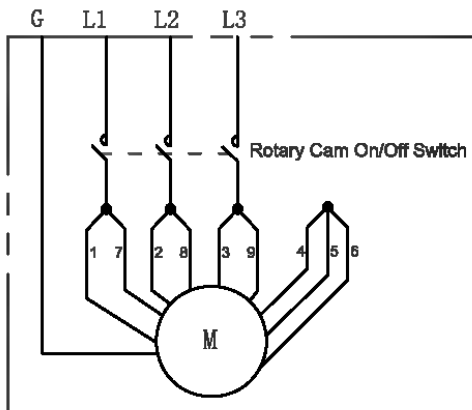

Wiring for 190/208-230V

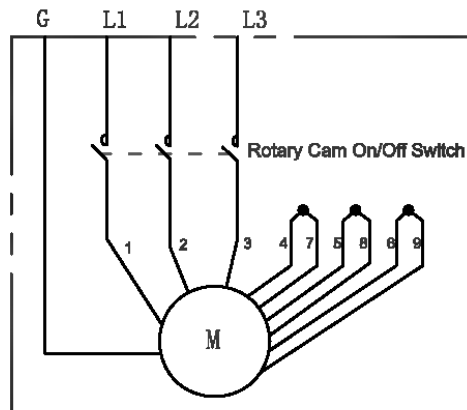

Wiring for 380/460V

Labels

A



B

⚠ DANGER	
VISUALLY CONFIRM THAT ALL PRIMARY SAFETY LOCKS ARE ENGAGED BEFORE ENTERING WORK AREA.	
Suspension components on this lift are intended to raise and lower lifts they are NOT load-holding devices. Do not go under an elevated lift until visual confirmation is made that the lift is engaged on its Safety Locks. Refer to the manual for proper Safety Lock procedures and additional instructions.	
VÉRIFIER VISUELLEMENT QUE TOUS LES VERROUS DE SÉCURITÉ PRIMAIRES SONT ENGAGÉS AVANT D'ENTRER DANS LA ZONE DE TRAVAIL.	
Les composants de suspension de cet élévateur sont destinés à élever et abaisser l'ascenseur; ce ne sont PAS des dispositifs de maintien de la charge. Ne passez pas sous un élévateur sans avoir visuellement obtenu la confirmation visuelle que l'ascenseur est engagé sur ses serrures de sécurité. Reportez-vous au manuel pour connaître les procédures de verrouillage de sécurité et les instructions supplémentaires.	
⚠ WARNING	
Wire Rope Inspection and Maintenance	
<ul style="list-style-type: none"> • Replace lifting cables if wear or damage is evident, such as excessive broken strands, kinks, deformities, or areas of heavy distortion. • Keep wire rope in good lubricated condition at all times. Wire rope is only fully protected when each wire strand is lubricated, both internally and externally. Excessive wear thins the life of wire rope. Use wire rope lubricant that penetrates to the core of the rope and provides long-term lubrication between individual strands. Lubrication should be done at least every three months during normal operation. • All sheaves and guide rollers in contact with the moving wire rope should be given regular visual checks for surface wear and lubricated to make sure they are free. This should be done at least every three months during normal operation. For sheave axes, use standard wheel bearing grease. For all sheaves and guide rollers, use 90-100 gear oil or similar heavy lubricant applied by any method including pump/spray dispensing, brush, hand, and/or swabbing. 	
Failure to read, understand, and follow these instructions may cause death or serious injury. Read and understand these instructions before using lift.	
⚠ ATTENTION	
Inspection et maintenance des câbles	
<ul style="list-style-type: none"> • Remplacez les câbles de levage si l'usure ou des dommages sont évidents, tels que des brins cassés, des torsions, des déformations ou des zones de forte abrasion excessive. • Gardez le câble métallique bien lubrifié en tout temps. Le câble métallique n'est entièrement protégé que lorsque chaque brin est lubrifié, à la fois à l'intérieur et à l'extérieur. Une usure excessive raccourcit la durée de vie du câble. Utilisez un lubrifiant pour câbles métalliques qui pénètre dans le noyau du câble et assure une lubrification à long terme entre les brins. La lubrification doit être effectuée au moins tous les trois mois en fonctionnement normal. • Toutes les poulies et les guides de guidage en contact avec le câble métallique en mouvement doivent être soumis à des contrôles visuels réguliers de l'usure de la surface et lubrifiés pour s'assurer de la fonctionnalité normale. Ces contrôles doivent être effectués au moins tous les trois mois pendant le fonctionnement normal. Pour les axes de poulies, utilisez de la graisse standard pour roulement de roue. Pour toutes les poulies et / ou les guides de guidage, utilisez de l'huile pour engrenages 90-100 ou un lubrifiant lourd similaire, appliqué selon l'imprégnation quelle méthode, y compris la distribution par pompe / spray, brosse, main et / ou éponge. 	
Lisez et comprenez ces instructions avant d'utiliser l'ascenseur. Ne pas lire, comprendre et suivre ces instructions peut provoquer des blessures graves, voire mortelles.	
IMPORTANT OPERATION / MAINTENANCE INSTRUCTIONS - PLEASE READ	
<p>TO RAISE LIFT</p> <ul style="list-style-type: none"> ✓ Position vehicle free of the extent of reach limits. ✓ Set parking brake or use wheel chock to hold vehicle in position. ✓ Before moving vehicle, be sure all controls are clear of lift and non-working area. Pay careful attention to overhead clearances. ✓ Raise lift to desired height by pressing up/down or power and. ✓ Maintain visual contact with cables and surrounding areas of frame while raising lift. ✓ Stop immediately if not stable or becomes unlevel. ✓ After vehicle is raised to desired height, lower lift onto the required Safety Lock. Do not allow cables to become excessively slack. ✓ Always make sure all Primary Safety Locks are engaged before entering work area. <p>TO LOWER LIFT</p> <ul style="list-style-type: none"> ✓ Make sure all personnel, tools, and equipment are clear of lift and surrounding area. ✓ Raise lift by pressing up/down or power and. Lower lift at slow rate and do not touch any other safety controls for back to down. ✓ Press and hold Stop before lift. ✓ Lower vehicle by slow pressing and holding Lowering handle. ✓ When lowering lift, make sure that all personnel and objects are kept clear. ✓ Always stop a second time to settle on return lowering. ✓ Always make sure safety locks are disengaged. If one of the locks inadvertently engages on descent, lift entire vehicle very slowly causing potential injury or death. <p>REQUIRED MONTHLY MAINTENANCE</p> <ul style="list-style-type: none"> ✓ Consult operator manual for factory recommended maintenance. ✓ Adjust lift cables to ensure lift rises level and Safety Locks engage automatically. ✓ Check all chainable connections, bolts and pins to ensure proper mounting. ✓ Visually inspect Safety Locks for proper operation. ✓ Visually inspect cables. Do not use lift if cables show signs of breaking or other deterioration. ✓ Inspect all roller balls, replace as necessary. ✓ Check posts for squareness and plumb. ✓ Inspect all bolts and other fasteners to make sure they are properly secured. ✓ Make a visual inspection of all moving parts and check the signs of excessive wear. ✓ Replace all faulty parts before lift is put back into operation. 	
<p>⚠ WARNING</p> <ul style="list-style-type: none"> • Warning: If electrical cables or any component of the lift is defective, do not use lift to lift or lower these loads. • Never operate lift with people or equipment under it. • Never exceed rated capacity. • Always ensure Safety Locks are engaged before any attempt is made to work on or near vehicle. • Do not remove electrical cables engaged on Safety Locks. • Do not touch the electric motor to lift and do not attempt to cover by employees and covered by the operator. 	<p>⚠ ATTENTION</p> <ul style="list-style-type: none"> • Attention: Si la structure ou la traction d'élevage sont défectueuses ou si un des composants de l'élevateur est défectueux, ne l'utilisez pas d'élever/lower ces charges. • Ne l'utilisez jamais avec des personnes ou des équipements sous l'ascenseur. • Ne jamais dépasser la capacité nominale. • Toujours s'assurer que les serrures de sécurité sont correctement engagées avant toute tentative de travailler sur ou près du véhicule. • Ne retirez pas les câbles électriques engagés sur les serrures de sécurité. • Ne touchez pas le moteur électrique de levage et ne tentez pas de le couvrir par les employés et par le conducteur.

C

⚠ CAUTION	⚠ CAUTION
<small>The messages and pictographs shown are generic in nature and are meant to generally represent hazards common to all automotive lifts regardless of specific make.</small>	<small>Funding for the development and validation of these labels was provided by the Automotive Lift Institute, P.O. Box 85 Cortland, NY 13845.</small>
<small>Replacement label sets may be obtained from the original lift manufacturer and ALI's member companies. They are protected by copyright.</small>	<small>www.ali.org</small>
⚠ WARNING	⚠ WARNING
⚠ WARNING	⚠ WARNING
⚠ WARNING	⚠ WARNING
<small>The messages and pictographs shown are generic in nature and are meant to generally represent hazards common to all automotive lifts regardless of specific make.</small>	<small>Funding for the development and validation of these labels was provided by the Automotive Lift Institute, P.O. Box 85 Cortland, NY 13845.</small>
<small>Replacement label sets may be obtained from the original lift manufacturer and ALI's member companies. They are protected by copyright.</small>	<small>www.ali.org</small>
NOTICE	NOTICE
NOTICE	
	<small>The messages and pictographs shown are generic in nature and are meant to generally represent hazards common to all automotive lifts regardless of specific make.</small>
<small>Do not operate a damaged lift.</small>	<small>Funding for the development and validation of these labels was provided by the Automotive Lift Institute, P.O. Box 85 Cortland, NY 13845.</small>
<small>Replacement label sets may be obtained from the original lift manufacturer and ALI's member companies. They are protected by copyright.</small>	<small>www.ali.org</small>
<small>© 2019 by ALI, Inc. ALI911-2019</small>	

D

⚠ DANGER

THE MAXIMUM LIFTING CAPACITY FOR THIS LIFT IS DESCRIBED BELOW

Maximum Lifting Capacity 9,000 lbs. / 4,082 kg
Max. Lifting Cap. / Front of Lift Center 4,500 lbs. / 2,041 kg
Max. Lifting Cap. / Rear of Lift Center 4,500 lbs. / 2,041 kg

Exceeding the weight capacity of this lift can damage lift and/or property and may cause personal harm, injury or death to operators and/or bystanders. All vehicles MUST be positioned on lift with CENTER OF GRAVITY midway between adapters and/or centered on runways. Damage to lift due to overloading or misuse IS NOT covered under warranty.

LA CAPACITÉ DE LEVAGE MAXIMUM POUR CE LEVAGE EST DÉCRIT CI-DESSOUS

Capacité de Levage Maximale 9,000 lbs. / 4,082 kg
Max. Capuchon De Levage. / Avant du centre de relèvement 4,500 lbs. / 2,041 kg
Max. Capuchon De Levage. / Arrière du centre de levage 4,500 lbs. / 2,041 kg

Le dépassement de la capacité de poids de cet élévateur peut endommager l'ascenseur et / ou les biens et peut causer des dommages corporels, des blessures voire la mort aux opérateurs et / ou aux passants. Tous les véhicules DOIVENT être placés sur l'élévateur avec le CENTRE DE GRAVITÉ à mi-chemin entre les adaptateurs et / ou au centre des pistes. Dommages à soulever dus à la surcharge ou une mauvaise utilisation N'EST PAS couverte par la garantie.

E

⚠ ATTENTION ⚠

**MAXIMUM LIFTING CAPACITY
CAPACITÉ DE LEVAGE MAXIMUM**

**9000 Lbs.
4082 Kg.**

F

BP BendPak PROVIDING AUTOMOTIVE SERVICE SOLUTIONS

SANTA PAULA, CA USA
WWW.BENDPAK.COM
PN 5905340

LIFT TYPE: SURFACE MOUNT MFG. BPK SEE DATA PLATE FOR PRODUCT DETAILS
POWER: ELECTRIC/HYDRAULIC INSTALLATION - SEE OWNERS GUIDE OR CONTACT FACTORY

SAFETY INSTRUCTIONS: IF ATTACHMENTS, ACCESSORIES OR CONFIGURATION MODIFYING COMPONENTS THAT ARE LOCATED IN THE LOAD PATH, AFFECT OPERATION OF THE LIFT, AFFECT THE LIFT ELECTRICAL LISTING OR AFFECT INTENDED VEHICLE ACCOMMODATION ARE USED ON THIS LIFT AND, IF THEY ARE NOT CERTIFIED FOR USE ON THIS LIFT, THEN THE CERTIFICATION OF THIS LIFT SHALL BECOME NULL AND VOID. CONTACT THE PARTICIPANT FOR INFORMATION PERTAINING TO CERTIFIED ATTACHMENTS, ACCESSORIES OR CONFIGURATION MODIFYING COMPONENTS.

BENDPAK LIFTS ARE SUPPLIED WITH CONCRETE FASTENERS MEETING THE CRITERIA AS PRESCRIBED BY ASTM E488 - 99(2003). LIFT BUYERS ARE RESPONSIBLE FOR ANY SPECIAL REGIONAL, STRUCTURAL AND/OR SEISMIC ANCHORING REQUIREMENTS SPECIFIED BY ANY OTHER AGENCIES AND/OR CODES SUCH AS THE UNIFORM BUILDING CODE (UBC) AND/OR INTERNATIONAL BUILDING CODE (IBC).

THE MANUFACTURE, USE, SALE OR IMPORT OF THIS PRODUCT MAY BE SUBJECT TO ONE OR MORE UNITED STATES PATENTS, OR PENDING APPLICATIONS, OWNED BY BENDPAK, INC.

DO NOT REMOVE ENGINEERED BY BENDPAK INC. USA MADE IN CHINA

G

NOTICE

If attachments, accessories, or configuration modifying components used on this lift are located in the load path and affect operation of the lift, affect the lift electrical listing, or affect intended vehicle accommodation; and if they are not certified for use on this lift, then the certification of this lift shall become null and void. Contact the participant for information pertaining to certified attachments, accessories, or configuration modifying components.

www.autolift.org ©2011 by ALI, Inc. ALI / WLSIA01

H

CERTIFIED AUTOMOTIVE LIFT

ALI CERTIFIED
To the provisions of ANSI/ALI ALCVT-2011 SAFETY REQUIREMENTS FOR CONSTRUCTION, TESTING AND VALIDATION

Automotive Lift Institute, Inc. | Cortland, NY 13045

MET LISTED
Conforms to ANSI/UL 201 SAFETY STANDARD FOR GARAGE EQUIPMENT

MET LISTED
MET Laboratories, Inc. BALTIMORE, MD 21230

Certification Label Serial Number
AL00617000J

I

BP BendPak Santa Paula, CA USA
www.bendpak.com

MODEL NUMBER	
DESCRIPTION	
LIFT CAPACITY	DATE OF MFG.
ROLLING JACK MAX CAP.	MAX PSI / BAR
VOLTAGE	SERIAL NUMBER
<input type="checkbox"/> 110-240V, 50-60 Hz, 1 Ph <input type="checkbox"/> 208-240V, 50-60 Hz, 1 Ph <input type="checkbox"/> 380-415V, 50-60 Hz, 3 Ph <input type="checkbox"/> 208-440V, 50-60 Hz, 3 Ph	UPC

⚠ DANGER! **CE EAC**
Discharge Power before Servicing

WARRANTY VOID IF DATA PLATE IS REMOVED PN 5905953

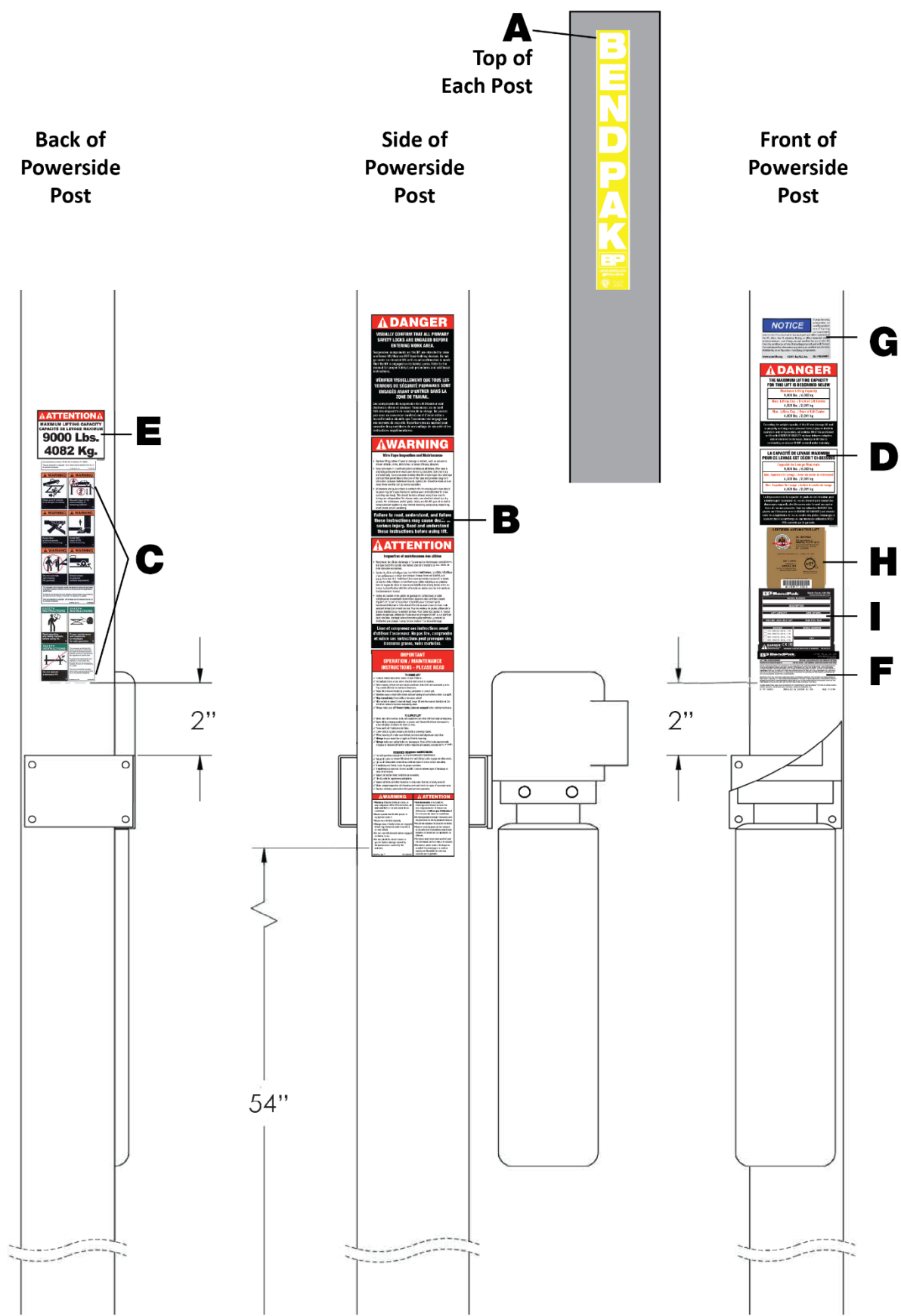

Parts Drawings

BP BendPak.	
1645 LEMONWOOD DR. SANTA PALMA, CA 93060	
TITLE: HD-9ST PRODUCTION LIFT VER K (CE CERT)	
SIZE DWG. NO.	REV
A 5260526	U
SCALE: 1:35	
SHEET 2 OF 2	

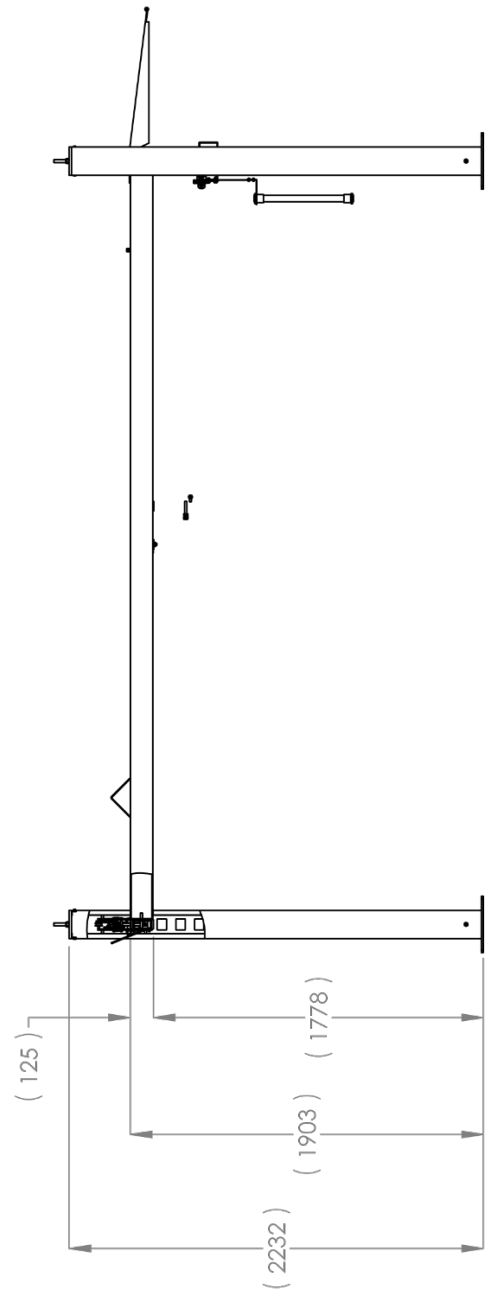
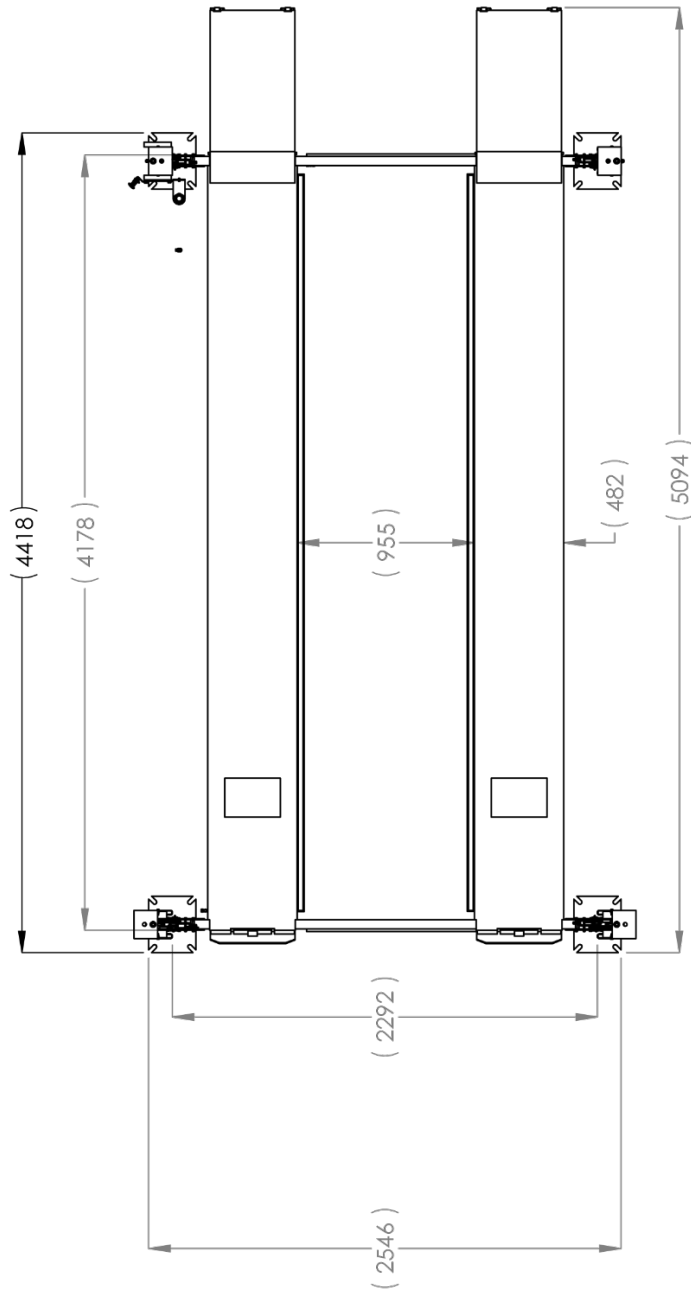

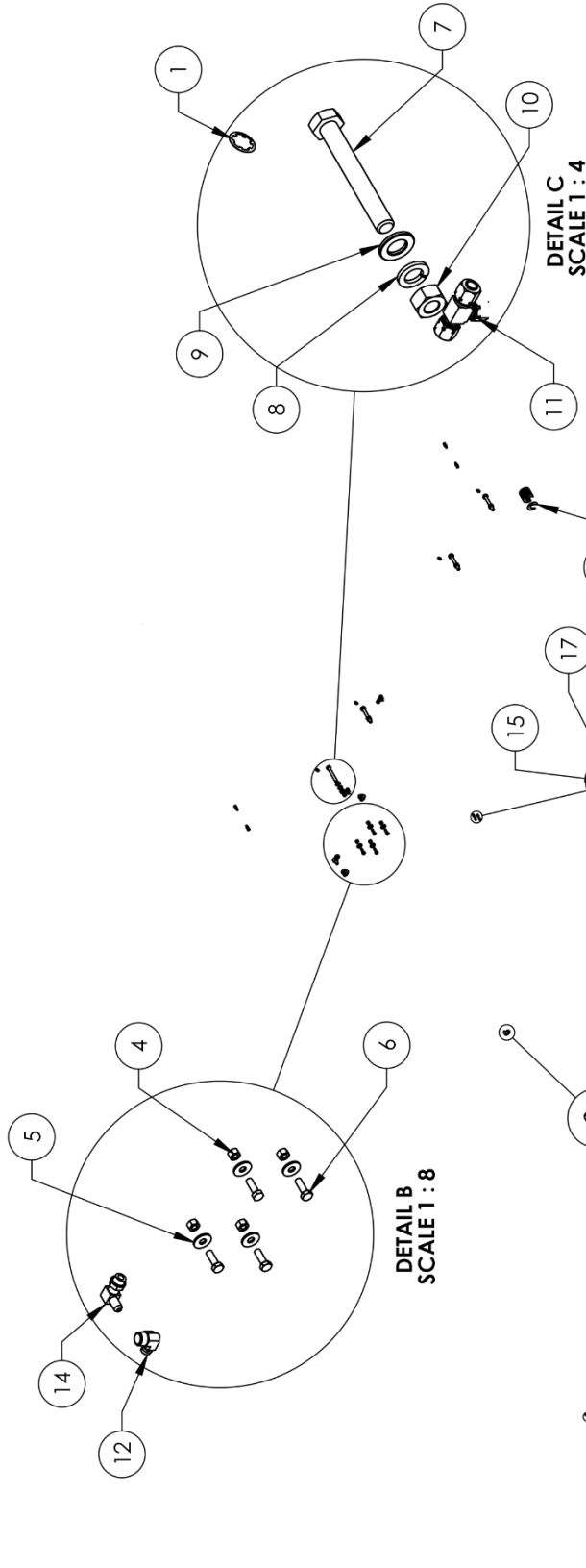

ITEM NO.	PART NUMBER	DESCRIPTION	QTY.	REV.
1	550503	ROTOR CLIP 12mm SS	8	-
2	5530756	HHB M6 X 1 X 25	8	-
3	5533357	NUT M6 X 1.0 NL	8	-
4	5535001	NUT M8 X 1.25 NL	4	A
5	5543340	WASHER MB X24 FLAT	4	-
6	5530010	HHB M8 X 1.25 X 25	4	B
7	5530009	HHB M12 X 1.75 X 90 CL18.8	8	-
8	5543201	WASHER M12 SPRING LOCK	8	-
9	5543347	WASHER M12 FLAT WASHER	8	-
10	5533354	NUT M12 X 1.75	8	-
11	5550395	FIG-TEE-04 COMP X-04 COMP X-04 COMP	3	-
12	5550089	FIG-FLB-04 COMP X-06 NPT	2	-
13	5550106	FIG-FLB-04 JIC-06 NPT	1	-
14	5550008	FIG-FLB-04 JIC-06 ORB	1	-
15	5545009	WASHER 24.3 X 29mm X 0.8mm	2	-
16	5530008	SHCS M4 X 0.7 X 12 ROC	2	-
17	5535010	NUT M4 X 0.7	2	-
18	5545335	C WASHER SHIM FOR LIFTS	20	-

DO NOT SCALE DRAWING

DIMENSIONS ARE IN MM

MATERIAL: ---

SIZE: ---

THIRD ANGLE PROJECTION

PROPERTY AND CONFIDENTIAL INFORMATION OF BENDPAK INC. IS HEREBY PROTECTED BY PATENT AND TRADE SECRET RIGHTS. REPRODUCTION IN ANY MANNER WITHOUT THE WRITTEN PERMISSION OF BENDPAK INC. IS PROHIBITED.

NAME: AC DATE: 08/08/2008

DRAWN: --- CHECKED: ---

BendPak
1645 LEMONWOOD DR.
SANTA PAULA, CA 93060

TITLE: HD- 9 SERIES PARTS BAG

SIZE DWG. NO. A 5174092

REV. E

SCALE: 1:30

SHEET 1 OF 1

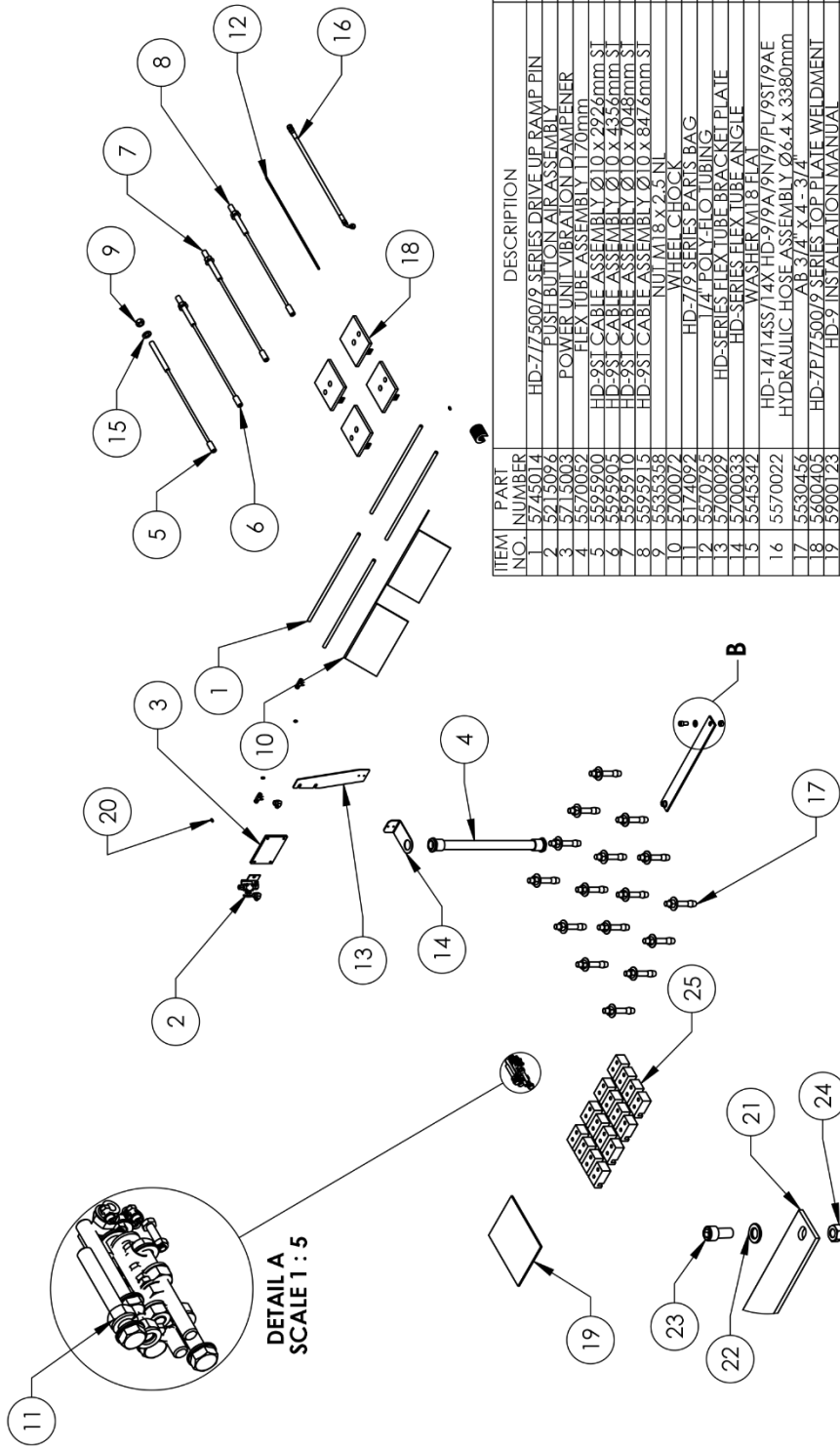

ITEM NO.	PART NUMBER	DESCRIPTION	QTY.	REV.
1	5745014	HD-77500/9 SERIES DRIVE UP RAMP PIN	4	B
2	5715094	PUSH BUTTON AIR ASSEMBLY	4	C
3	5715003	POWER UNIT VIBRATION DAMPENER	1	B
4	5570052	FLEX TUBE ASSEMBLY 170mm	1	C
5	5595900	HD-9ST CABLE ASSEMBLY Ø10 x 2926mm S1	1	C
6	5595903	HD-9ST CABLE ASSEMBLY Ø10 x 4356mm S1	1	C
7	5595910	HD-9ST CABLE ASSEMBLY Ø10 x 7088mm S1	1	C
8	5595915	HD-9ST CABLE ASSEMBLY Ø10 x 8476mm S1	1	C
9	5533358	NUT M18 X 2.5 N	4	C
10	5700072	WHEEL CHOCK	2	B
11	5174092	HD-779 SERIES PARTS BAG	1	E
12	5707095	1/4" POLY FLO TUBING	17000*mm	E
13	5700026	HD-SERIES FLEX TUBE BRACKET PLATE	4	E
14	5700033	HD-SERIES FLEX TUBE ANGLE	4	E
15	5545342	WASHER M18 FLAT	4	-
16	5570022	HD-1414SS/14X HD-9/A/9N/9/PL/9ST/9AE HYDRAULIC HOSE ASSEMBLY Ø6.4 x 3380mm AR 37.4° x 37.4°	1	G
17	5530456	HD-77500/9 SERIES TOP PLATE WELDMENT	16	C
18	5600406	HD-9 INSTALLATION MANUAL	4	-
19	5900123	FIG. GR5 M6 X 1.0	8	-
20	5735663	HD-9 SERIES RAMP STRAP BOLT ON WASHER M12 FLAT WASHER	2	B
21	5545347	SHCS M12 X 1.75 X 25mm	2	-
22	5530061	NUT M12 X 1.75 N	2	-
23	5535012	HD-77500/9/14/HD90-14 POLYETHYLENE SLIDE BLOCK	16	L
24	5716005			

		1645 LEMONWOOD DR. SANTA PAULA, CA 93060	
DRAWN TM	DATE 05/09/2013	CHECKED CA	DATE 10/30/2018
TITLE: PARTS BOX HD-9ST			
DIMENSIONS ARE IN MM		THIRD ANGLE PROJECTION	
		SIZE DWG. NO. A 5250188	
PROPRIETARY AND CONFIDENTIAL THE INFORMATION CONTAINED IN THIS DRAWING IS THE PROPERTY OF BENDPAK INC. AND IS NOT TO BE REPRODUCED IN ANY MANNER WITHOUT THE WRITTEN PERMISSION OF BENDPAK INC.		REV J	
SCALE: 1:25			SHEET 1 OF 1

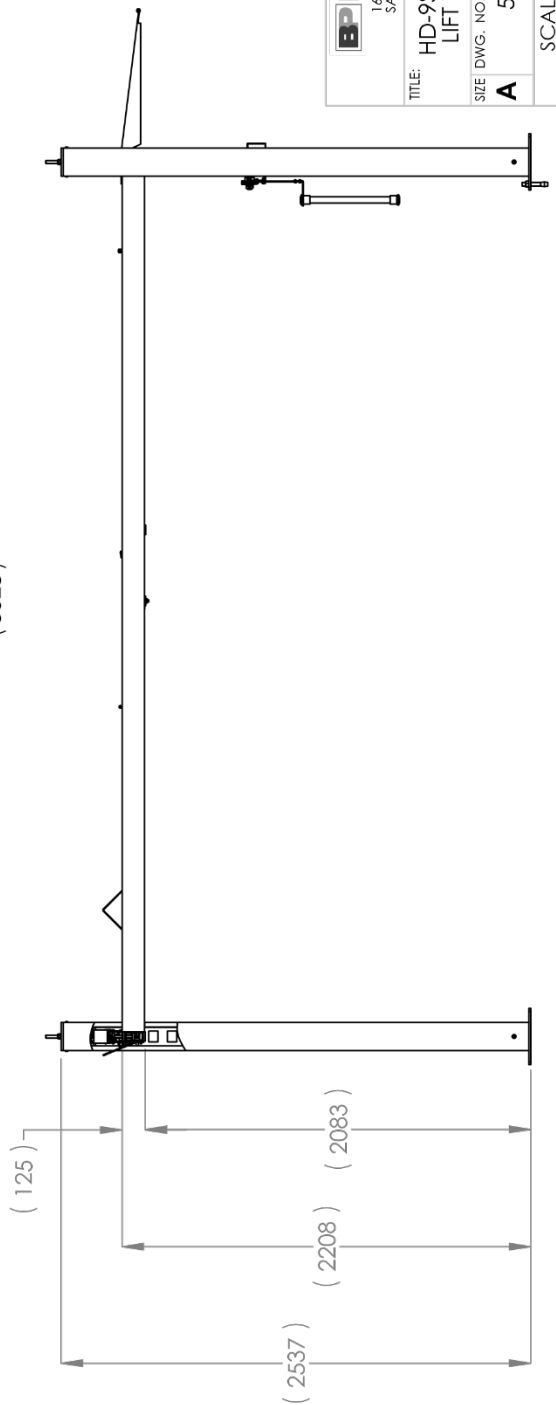
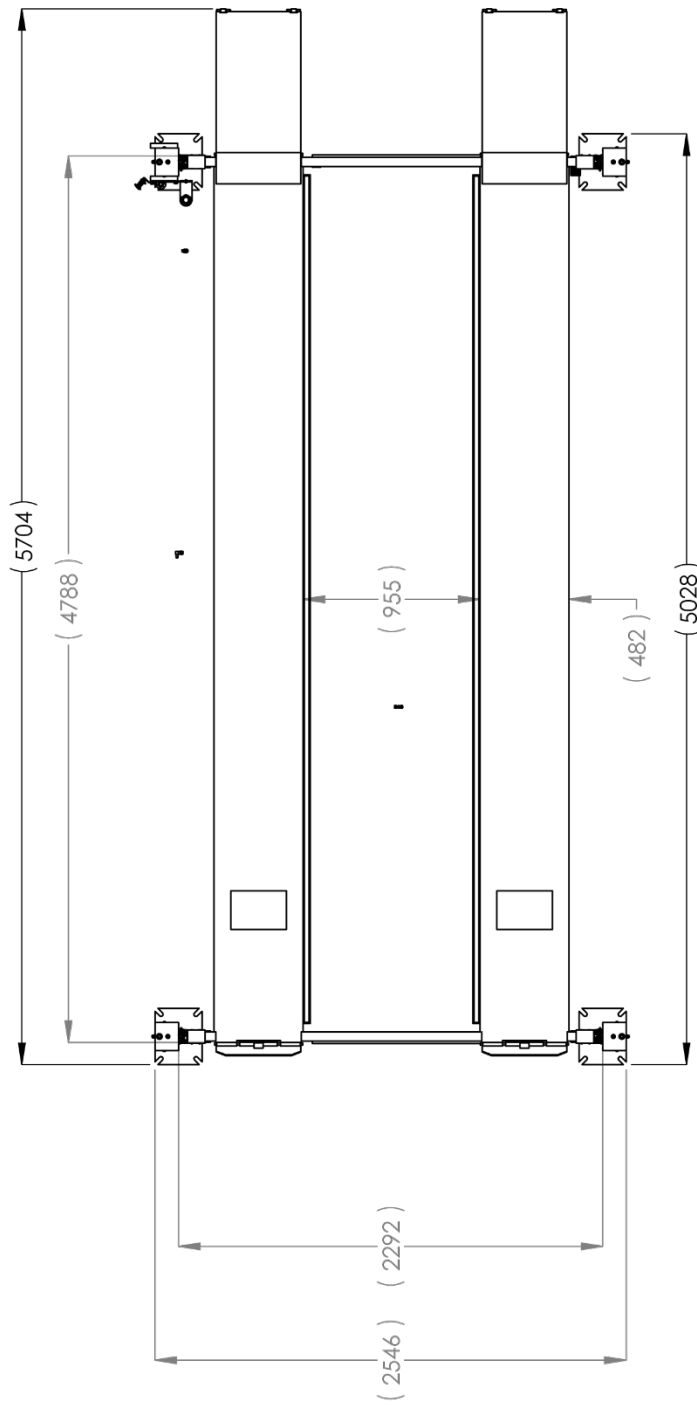

BendPak 1645 LEMONWOOD DR. SANTA PAULA, CA 95660	
TITLE:	HD-9STX PRODUCTION LIFT VER K (CE CERT)
SIZE DWG. NO.	REV
A	5260528 U
SCALE: 1:35 SHEET 2 OF 2	

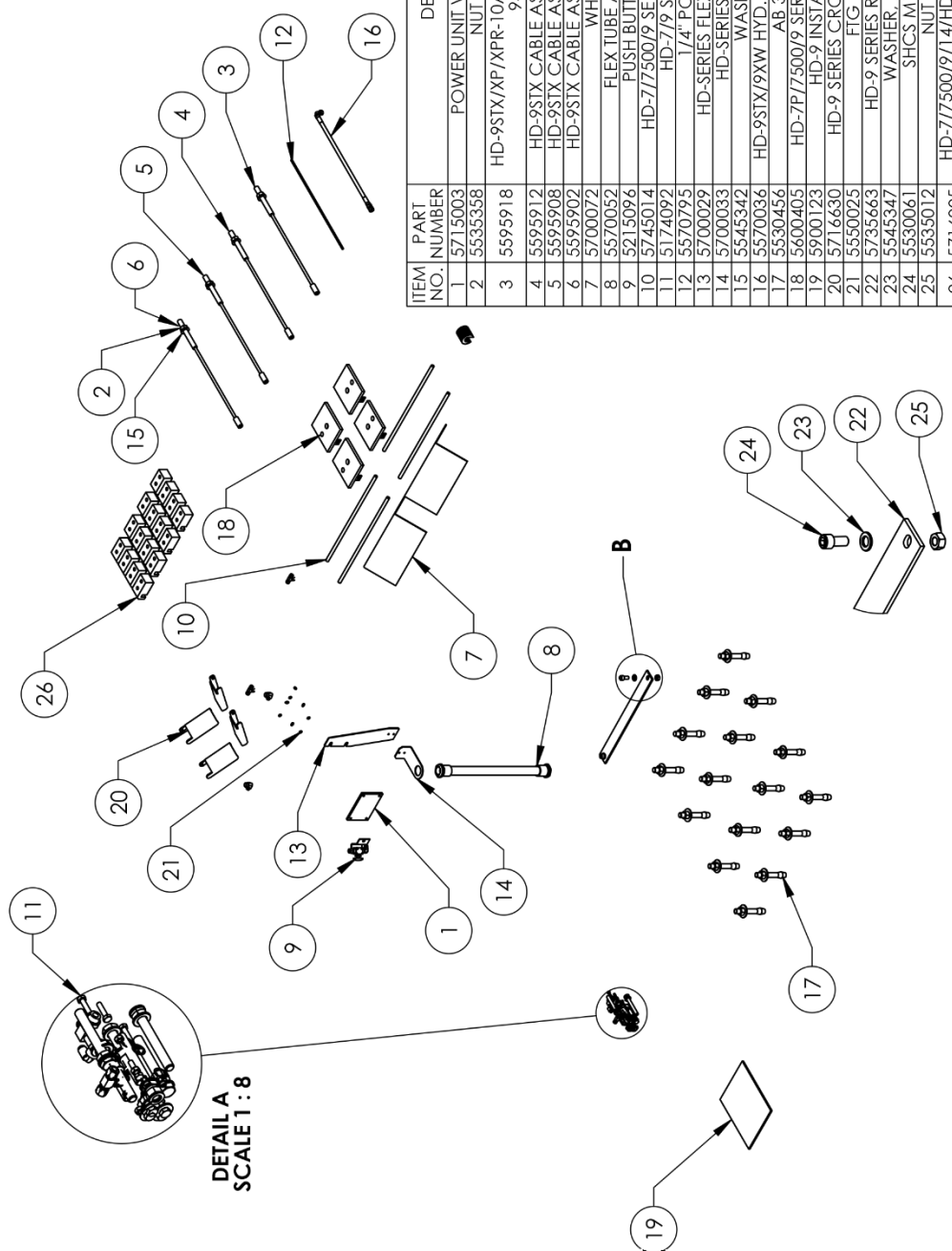

ITEM NO.	PART NUMBER	DESCRIPTION	QTY.	REV
1	5715003	POWER UNIT VIBRATION DAMPENER	1	B
2	5535358	NUT M18 x 2.5 NL	4	-
3	5595918	HD-9STX/XP/XP/10ACX CABLE ASSEMBLY Ø10 x 9404mm ST	1	E
4	5595912	HD-9STX CABLE ASSEMBLY Ø10 x 7978mm ST	1	F
5	5595908	HD-9STX CABLE ASSEMBLY Ø10 x 4663mm ST	1	F
6	5595902	HD-9STX CABLE ASSEMBLY Ø10 x 3240mm ST	1	G
7	5700072	WHEEL CHOCK	2	B
8	5570052	FLEX TUBE ASSEMBLY 1170mm	1	B
9	5215096	PUSH BUTTON AIR ASSEMBLY	1	G
10	5745014	HD-7/7500/9 SERIES DRIVE UP RAMP PIN	4	B
11	5174092	HD-7/9 SERIES PARTS BAG	1	E
12	5570795	1/4" POLY-FLO TUBING	17000*mm	-
13	5700029	HD-SERIES FLEX TUBE BRACKET PLATE	1	F
14	5700033	HD-SERIES FLEX TUBE ANGLE	1	E
15	5545342	WASHER M18 FLAT	4	-
16	5570036	HD-9STX/9XW HYD. HOSE ASSY. Ø6.4 x 3683mm	1	E
17	5530456	AB 3/4" x 4" - 3/4"	16	-
18	5600405	HD-7P/7500/9 SERIES TOP PLATE WELDMENT	4	C
19	5900123	HD-9 INSTALLATION MANUAL	1	-
20	5716630	HD-9 SERIES CROSSTUBE COVER, PLASTIC	4	A
21	5550025	FIG GRS M6 x 1.0	8	-
22	5735663	HD-9 SERIES RAMP STRAP, BOLT ON	1	B
23	5545347	WASHER, M12 FLAT WASHER	2	-
24	5530061	SHCS M12x1.75 x 25mmL	2	-
25	5535012	NUT M12x1.75 NL	2	-
26	5716005	HD-7/7500/9/14/HDSO-14 POLYETHYLENE SLIDE	16	L

DO NOT SCALE DRAWING

NAME: _____ DATE: _____

DRAWN: TM 05/09/2013

CHECKED: CA 10/30/2018

THIRD ANGLE PROJECTION

PROPRIETARY AND CONFIDENTIAL
THE SOLE PROPERTY OF BENDPAK INC. ANY
REPRODUCTION OR TRANSMISSION WITHOUT
THE WRITTEN PERMISSION OF BENDPAK INC. IS
PROHIBITED.

DIMENSIONS ARE IN MM

BendPak.
1645 LEMONWOOD DR.
SANTA ANA, CA 92660

TITLE: PARTS BOX HD-9STX

SIZE DWG. NO. A 5250189

REV K

SCALE: 1:25

SHEET 1 OF 1

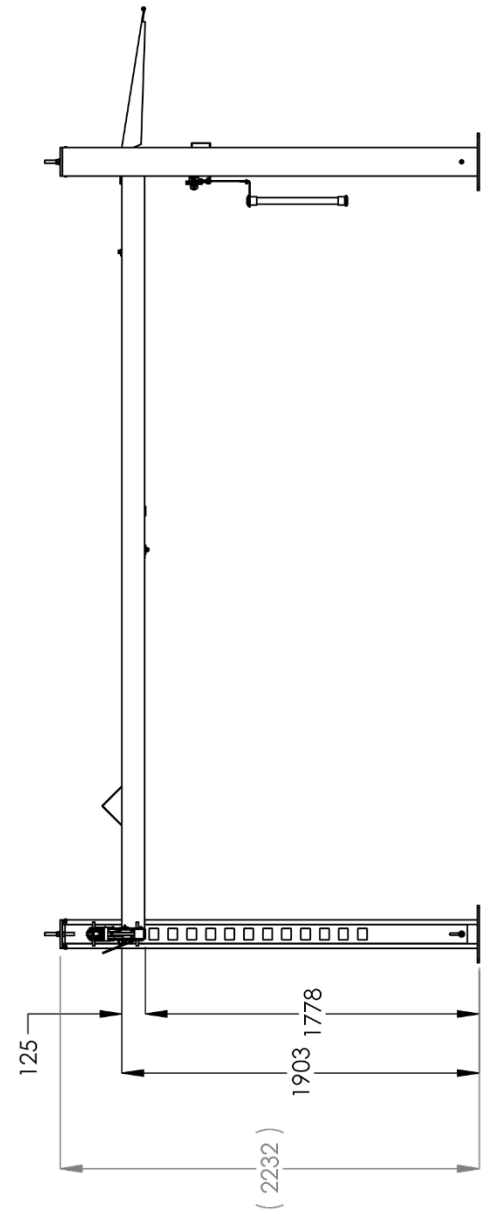
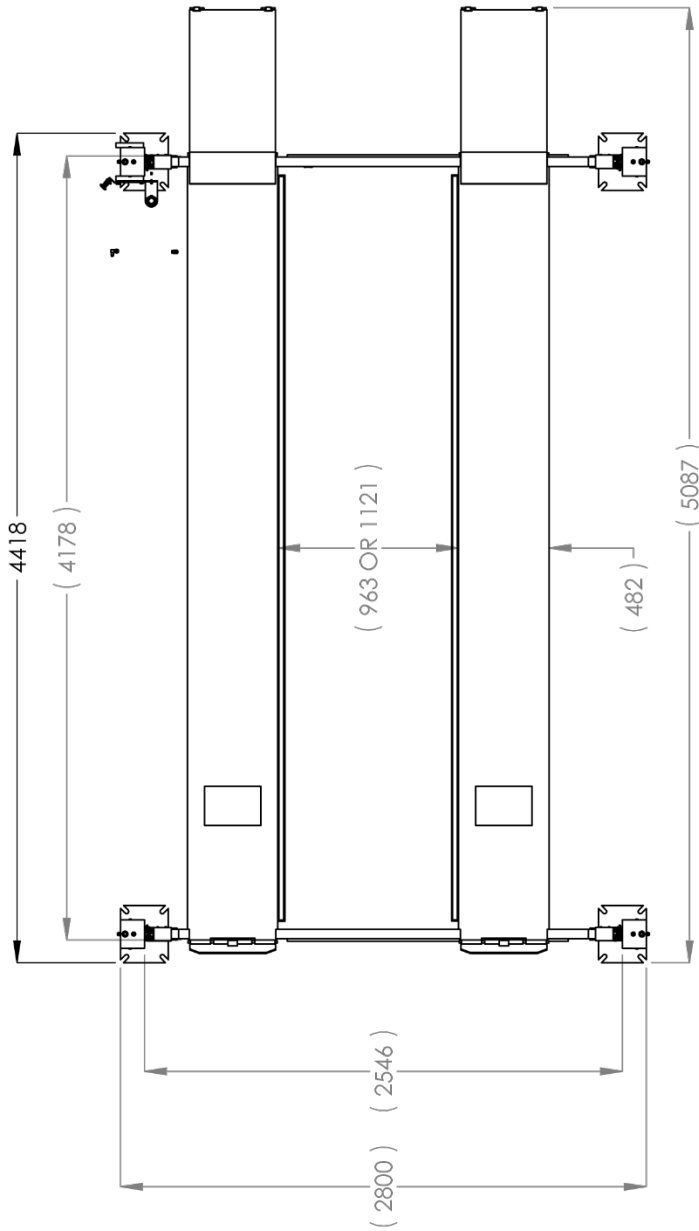

1645 LEMONWOOD DR. SANTA PAULA, CA 93060	
TITLE:	HD-9 PRODUCTION LIFT VER L (CE CERT)
SIZE DWG. NO.	A 5260516
REV	U
SCALE: 1:35	
SHEET 2 OF 2	

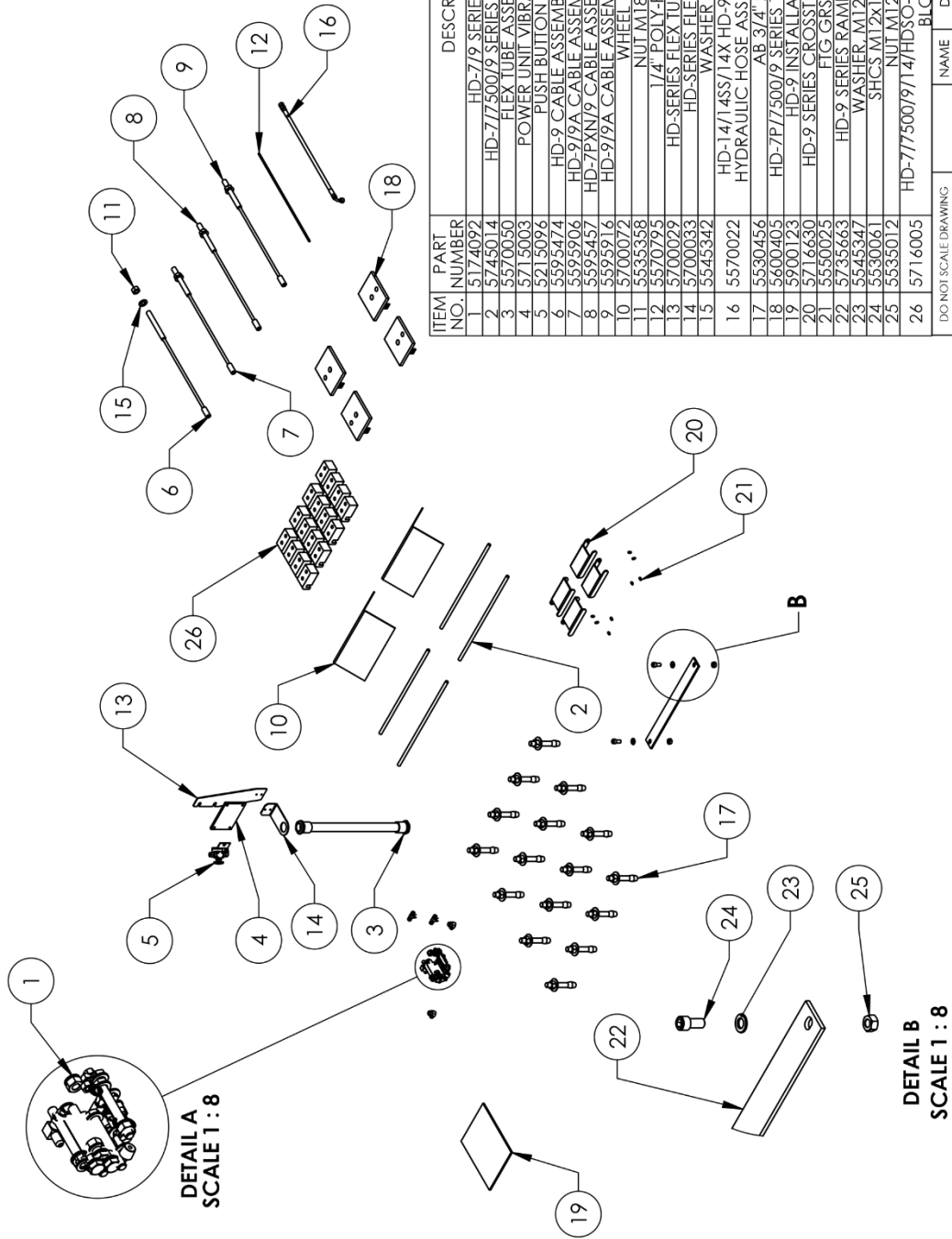

DETAIL A
SCALE 1 : 8

DETAIL B
SCALE 1 : 8

ITEM NO.	PART NUMBER	DESCRIPTION	QTY.	REV.
1	5174092	HD-7/9 SERIES PARTS BAG	1	E
2	5745014	HD-7/7500/9 SERIES DRIVE UP RAMP PIN	4	B
3	5970050	FLEX TUBE ASSEMBLY 1320mm	1	B
4	5715003	POWER UNIT VIBRATION DAMPENER	1	B
5	5215096	PUSH BUTTON AIR ASSEMBLY	1	G
6	5595474	HD-9 CABLE ASSEMBLY Ø10 x 2958mm ST	1	B
7	5595906	HD-9/9A CABLE ASSEMBLY Ø10 x 4578mm ST	1	F
8	5595457	HD-7/PXN/9 CABLE ASSEMBLY Ø10 x 7094mm ST	1	-
9	5595916	HD-9/9A CABLE ASSEMBLY Ø10 x 8706mm ST	1	G
10	5700072	WHEEL CHOCK	2	B
11	5533358	NUJ M18 X 2.5 NL	4	-
12	5570795	1/4" POLY-FLO TUBING	17000*mm	-
13	5700029	HD-SERIES FLEX TUBE BRACKET PLATE	1	F
14	5700033	HD-SERIES FLEX TUBE ANGLE	1	E
15	5545342	WASHER M18 FLAT	4	-
16	5570022	HD-14/14SS/14X HD-9/9A/9N/9/PL/9ST/9AE HYDRAULIC HOSE ASSEMBLY Ø6.4 x 3380mm	1	G
17	5530456	AB 3/4" x 4 - 3/4"	16	-
18	5600405	HD-7/7500/9 SERIES TOP PLATE WELDMENT	4	C
19	5900123	HD-9 INSTALLATION MANUAL	1	-
20	5716630	HD-9 SERIES CROSSTUBE COVER, PLASTIC	4	A
21	5550025	FIG GRS M6 x 1.0	8	-
22	5735663	HD-9 SERIES RAMP STRAP BOLT ON	1	B
23	5543347	WASHER M12 FLAT WASHER	2	-
24	5530061	SHCS M12 X 1.75 X 2.5mm	2	-
25	5535012	NUJ M12 X 1.75 NL	2	-
26	5716005	HD-77500/9/174/HDSO-14 POLYETHYLENE SLIDE BLOCK	16	L

DO NOT SCALE DRAWING

NAME: **BendPak** DATE: 05/07/2013

DRAWN: TM CHECKED: CA 10/30/2018

THIRD ANGLE PROJECTION

TITLE: PARTS BOX HD-9

SIZE DWG. NO. 5250167

REV. J

SHEET 1 OF 1

1645 LEMONWOOD DR. SANTA PAULA, CA 93060

PROPRIETARY AND CONFIDENTIAL
THE INFORMATION CONTAINED HEREIN IS THE PROPERTY OF BENDPAK INC. REPRODUCTION IN PART OR AS A WHOLE WITHOUT PERMISSION BY BENDPAK INC. IS PROHIBITED.

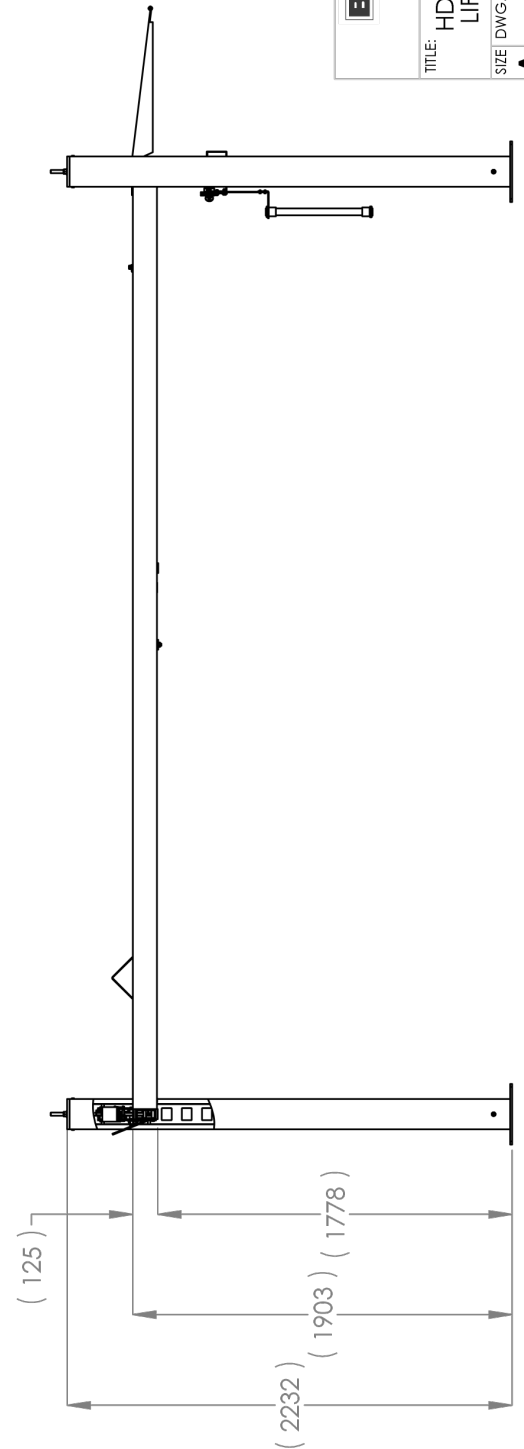
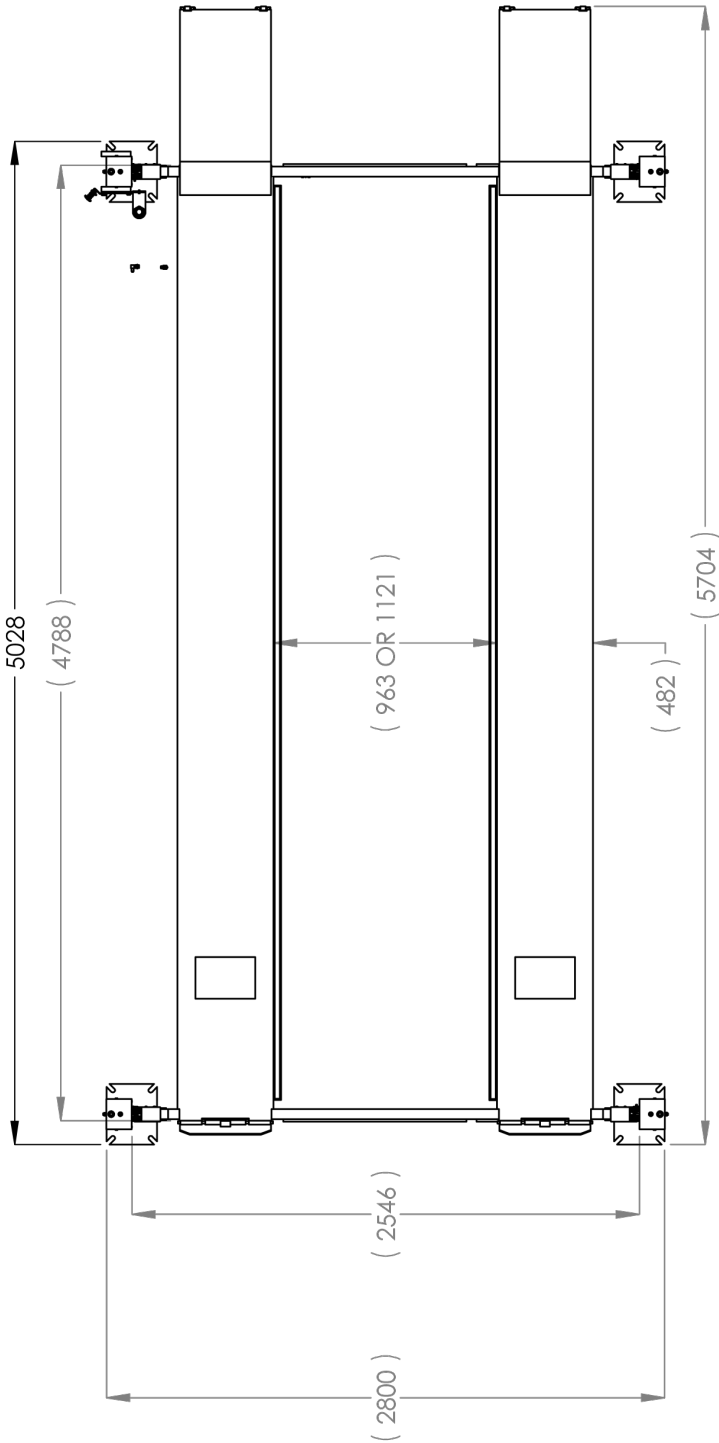

BP BendPak.	
1645 LEMONWOOD DR. SANTA PAULA, CA 93060	
TITLE: HD-9XL PRODUCTION LIFT VER E (CE CERT)	
SIZE DWG. NO.	REV
A	T
SCALE: 1:35	
SHEET 2 OF 2	

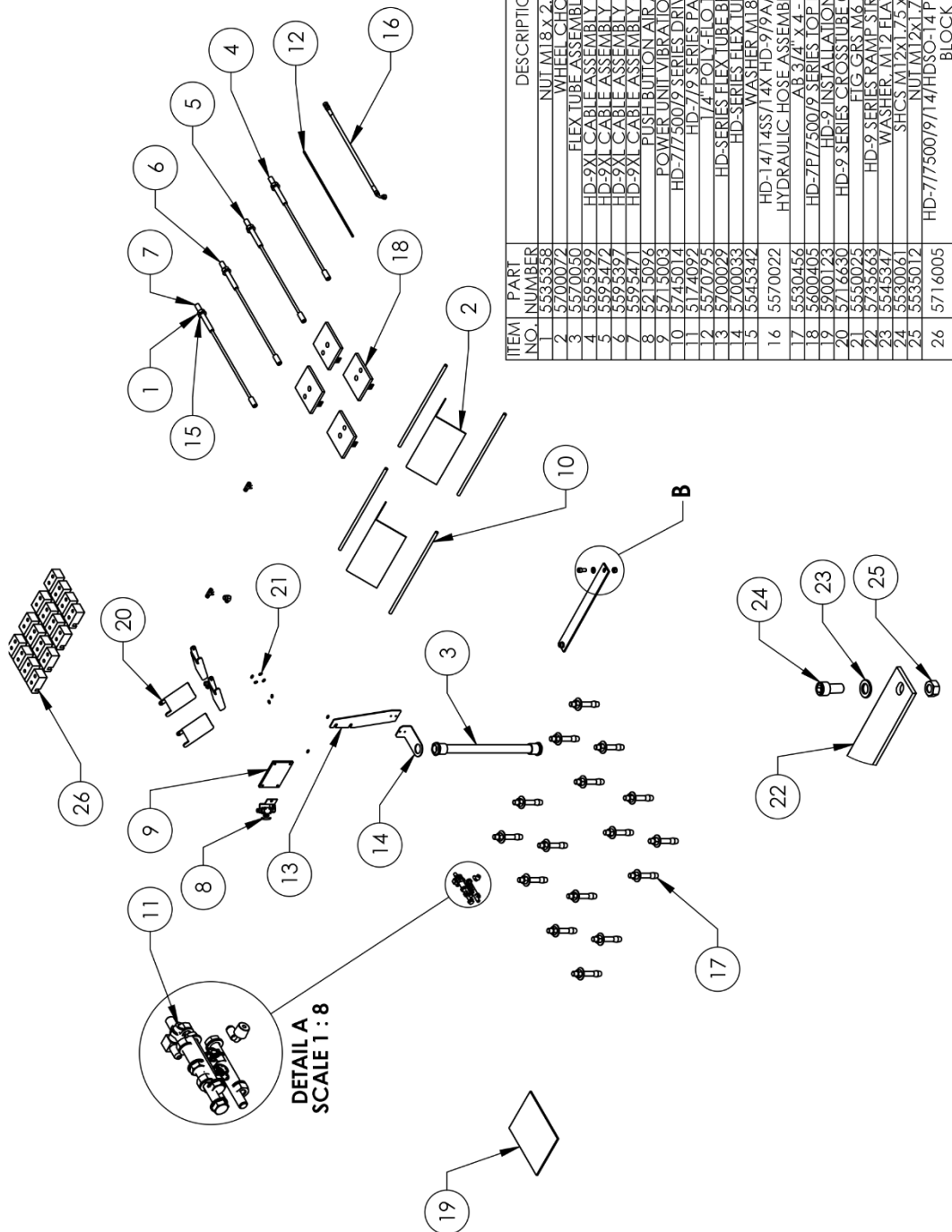

**DETAIL A
SCALE 1 : 8**

**DETAIL B
SCALE 1 : 8**

ITEM NO.	PART NUMBER	DESCRIPTION	QTY.	REV.
1	5533358	NUT M18 X 2.5 INL	4	-
2	5700072	WHEEL CHOCK	2	B
3	5570050	FLEX TUBE ASSEMBLY 1320mm	-	B
4	5593399	HD-9XL CABLE ASSEMBLY Ø10 x 9932mm ST	-	B
5	5593472	HD-9XL CABLE ASSEMBLY Ø10 x 8332mm ST	-	B
6	5593397	HD-9XL CABLE ASSEMBLY Ø10 x 5195mm ST	-	B
7	5593471	HD-9XL CABLE ASSEMBLY Ø10 x 3382mm ST	-	B
8	5215096	PUSH BUTTON AIR ASSEMBLY	1	G
9	5715003	POWER UNIT VIBRATION DAMPENER	1	B
10	5745014	HD-77500/9 SERIES DRIVE UP RAMP PIN	4	B
11	5174092	HD-779 SERIES PARTS BAG	1	E
12	5570795	1/4" POLY-FLO TUBING	17000*mm	-
13	5700029	HD-SERIES FLEX TUBE BRACKET PLATE	-	F
14	5700033	HD-SERIES FLEX TUBE ANGLE	4	E
15	5545342	WASHER M18 FLAT	4	-
16	5570022	HD-14145S/14X HD-9/9A/9N/9PL/9ST/9AE HYDRAULIC HOSE ASSEMBLY Ø6.4 x 3380mm	1	G
17	5530456	AB 3/4" X 4 - 3/4"	16	A
18	5600405	HD-7P/7500/9 SERIES TOP PLATE WELDMENT	4	C
19	5900123	HD-9 INSTALLATION MANUAL	4	-
20	5714630	HD-9 SERIES CROSSTUBE COVER-PLASTIC	4	A
21	5550023	FIG. GRN. M4 X 0	8	-
22	5239723	HD-9 SERIES GRN. M4 X 0 BOLT ON WASHER M10 FLAT WASHER	2	B
23	5530041	SHCS M12 X 7.2mm L	2	-
24	5530061	NUT M12 X 9mm	2	-
25	5535012	HD-77500/9/14/HD50-14 POLYETHYLENE SLIDE BLOCK	2	-
26	5716005	HD-77500/9/14/HD50-14 POLYETHYLENE SLIDE BLOCK	16	L

BendPak.
1445 LEMMONWOOD DR.
SANTA PAULA, CA 93060

TITLE: PARTS BOX HD-9XL

SIZE DWG. NO. **A** 5250169

REV **K**

SCALE: 1:25

SHEET 1 OF 1

DO NOT SCALE DRAWING

DRAWN TIM 05/07/2013

CHECKED CA 10/30/2018

THIRD ANGLE PROJECTION

PROPERTY AND CONFIDENTIALITY NOTICE: THIS DRAWING IS THE SOLE PROPERTY OF BENDPAK INC. ANY REPRODUCTION OR TRANSMISSION WITHOUT THE WRITTEN PERMISSION OF BENDPAK INC. IS PROHIBITED.

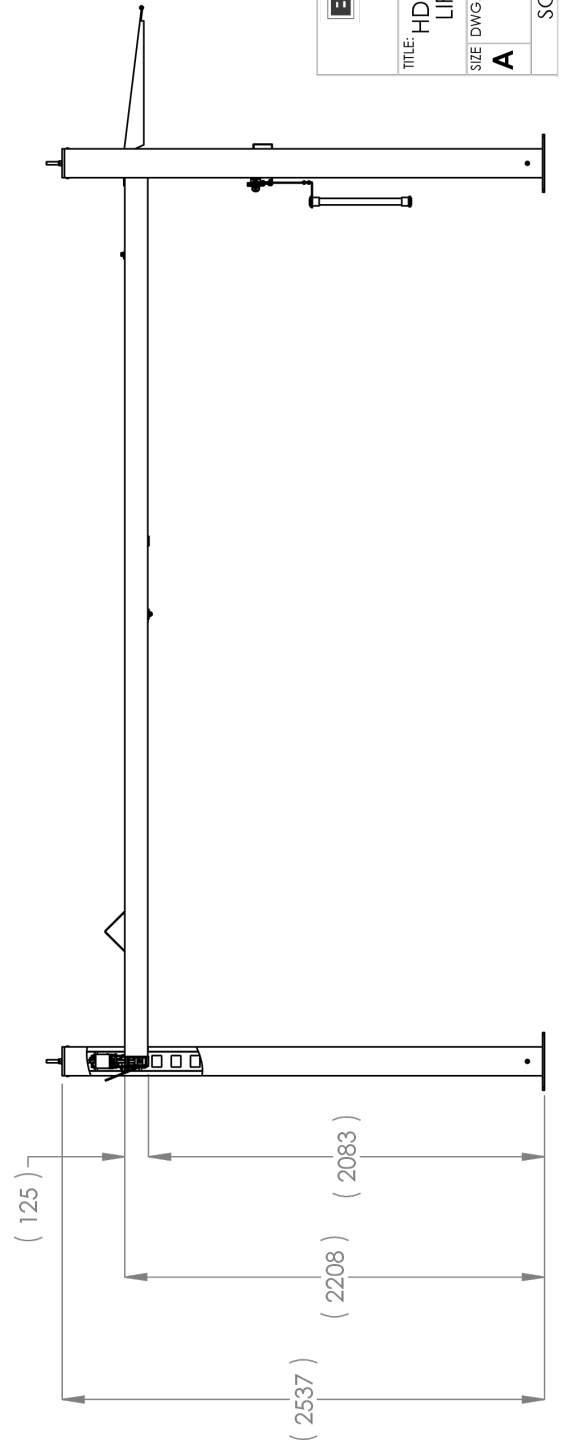
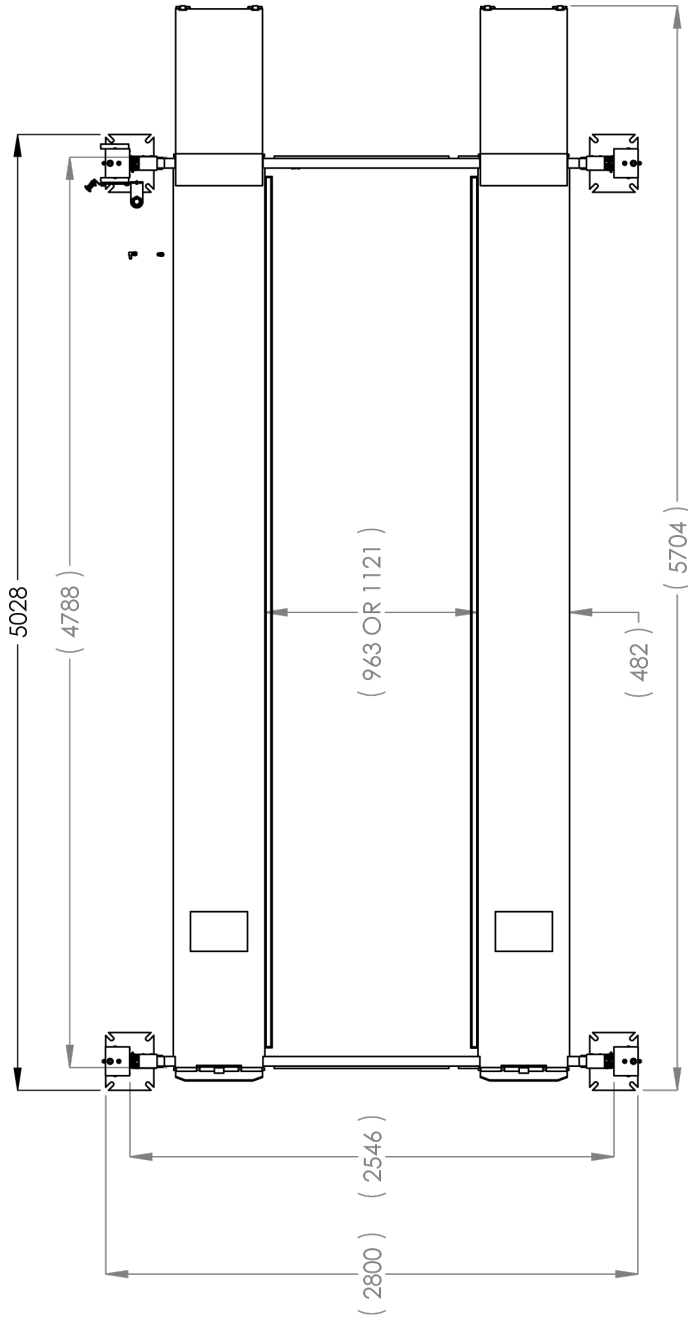

BendPak.	
1645 LENOXWOOD DR. SANTA PAULA, CA 93060	
TITLE: HD-9XW PRODUCTION LIFT VER L (CE CERT)	
SIZE DWG. NO. A	REV U
SCALE: 1:35	
SHEET 2 OF 2	

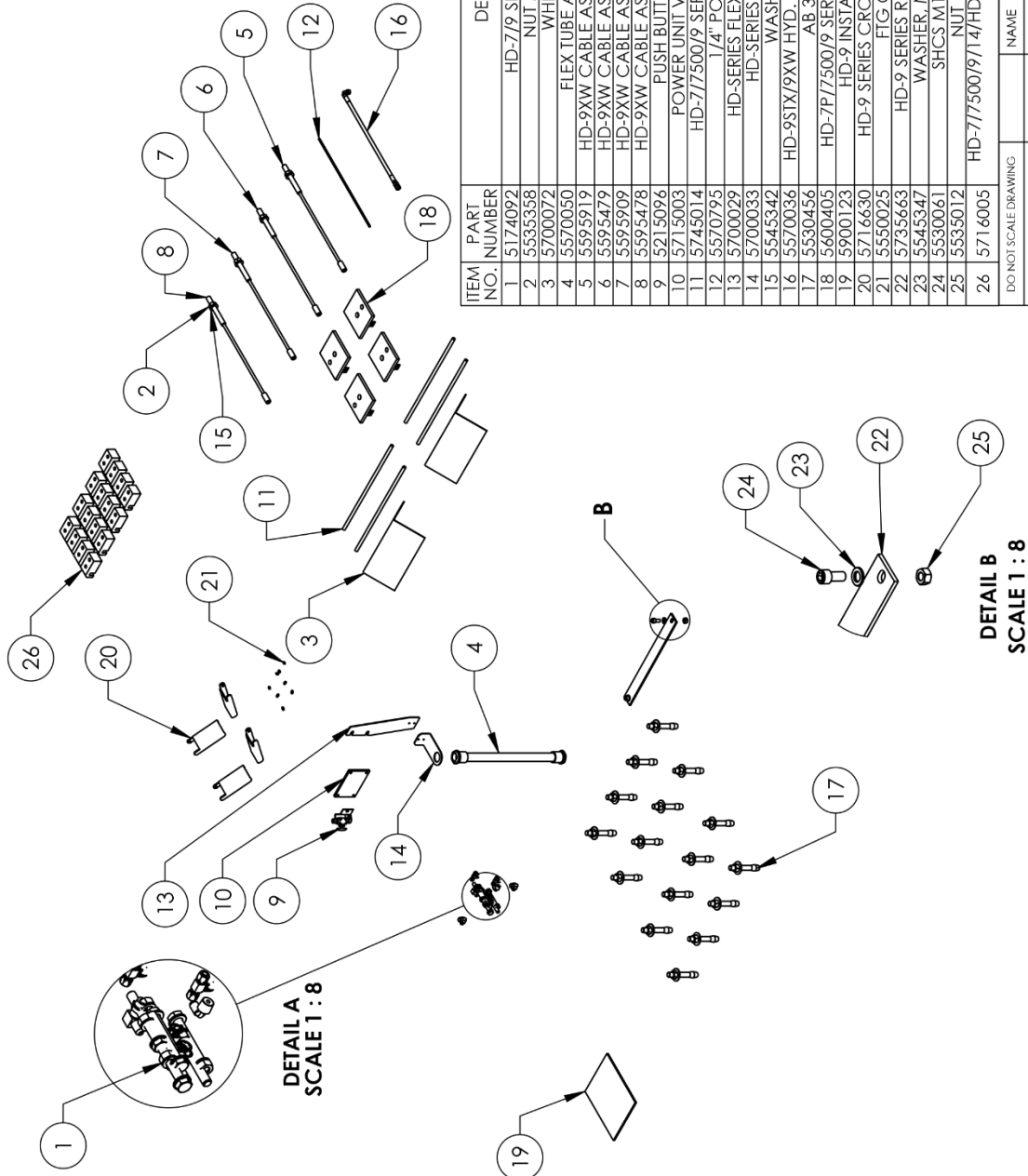

ITEM NO.	PART NUMBER	DESCRIPTION	QTY.	REV
1	5174092	HD-7/9 SERIES PARTS BAG	1	E
2	5535358	NUT M18 x 2.5 NL	4	-
3	5700072	WHEEL CHOCK	2	B
4	5570050	FLEX TUBE ASSEMBLY 1320mm	1	B
5	5595919	HD-9XW CABLE ASSEMBLY Ø10 x 9613mm ST	1	F
6	5595479	HD-9XW CABLE ASSEMBLY Ø10 x 8007mm ST	1	B
7	5595909	HD-9XW CABLE ASSEMBLY Ø10 x 4883mm ST	1	E
8	5595478	HD-9XW CABLE ASSEMBLY Ø10 x 3263mm ST	1	B
9	5215096	PUSH BUTTON AIR ASSEMBLY	1	G
10	5715003	POWER UNIT VIBRATION DAMPENER	1	B
11	5745014	HD-7/7500/9 SERIES DRIVE UP RAMP PIN	4	B
12	5570795	1/4" POLY-FLO TUBING	17000*mm	-
13	5700029	HD-SERIES FLEX TUBE BRACKET PLATE	1	F
14	5700033	HD-SERIES FLEX TUBE ANGLE	1	E
15	5545342	WASHER M18 FLAT	4	-
16	5570036	HD-9STX/9XW HYD. HOSE ASSY Ø6.4 x 3683mm	1	E
17	5530456	AB 3/4" x 4 - 3/4"	16	-
18	5600405	HD-7/7500/9 SERIES TOP PLATE WELDMENT	4	C
19	5900123	HD-9 INSTALLATION MANUAL	1	-
20	5716630	HD-9 SERIES CROSSTUBE COVER, PLASTIC	4	A
21	5550025	FIG GRS M6 x 1.0	8	-
22	5735663	HD-9 SERIES RAMP STRAP, BOLT ON	1	B
23	5545347	WASHER M12 FLAT WASHER	2	-
24	5530061	SHCS M12x1.75 x 25mmML	2	-
25	5535012	NUT M12x1.75 NL	2	-
26	5716005	HD-7/7500/9/14/HDSO-14 POLYETHYLENE SLIDE BLOCK	16	L

BPI BendPak.
 1645 LEMONWOOD DR.
 SANTA PAULA, CA 93060

TITLE: PARTS BOX HD-9XW
 SIZE DWG. NO. 5250168
 REV K

DO NOT SCALE DRAWING
 DRAWN TM 05/07/2013
 CHECKED CA 10/30/2018
 THIRD ANGLE PROJECTION

DIMENSIONS ARE IN MM

PROPRIETARY AND CONFIDENTIAL
 THE SCALE PROPERTY OF BENDPAK INC. ANY
 REPRODUCTION IN PART OR AS A WHOLE WITHOUT
 THE WRITTEN PERMISSION OF BENDPAK INC. IS
 PROHIBITED.

SHEET 1 OF 1

Declaration of Conformity

The equipment which accompanies this declaration is in conformity with EU Directive: 2006/42/EC Machinery Directive

Manufacturer
 BendPak Inc.
 1645 Lemonwood Dr.
 Santa Paula, CA 93060,
 USA

A copy of the technical file for this equipment is available from:
 CCGS UK Ltd.,
 level 7, Westgate House, Westgate Rd.,
 London W5 1YY UK

Description of Equipment

Vehicle Servicing Lifts

Model	Capacity (lb)	Design	Width(in)	Legth(in)	Max Lift(in)
HD-9ST	9,000	4 Post	100	200	70
HD-9	9,000	4 Post	110	200	70
HD-9STX	9,000	4 Post	100	225	82
HD-9XW	9,000	4 Post	110	225	82
HD-9XL	9,000	4 Post	110	225	82

A sample of this machinery has been presented to Notified Body number 1105.
 CCGS UK Ltd., level 7, Westgate House, Westgate Rd., London W5 1YY UK
 Who have issued an EC-type examination certificate
 Number CE-GB-20120209-01-01-5A dated 2014.01.27

The equipment in respect of which this declaration is made conforms to the example to which that certificate relates, and that certificate remains valid.

The following harmonised standards have been used:-
 EN 1493:2010 Vehicle Lifts

Authorised signatory of manufacturer

Signature: 

Name of signatory: Jeff Kritzer
 Position in company: SVP Sales/Marketing

Place signed: Santa Paula CA
 Date signed: 11.6.2013



Automotive Lift Institute (ALI) Store

You probably checked the [ALI's Directory of Certified Lifts](http://www.autolift.org/ali-directory-of-certified-lifts/) (www.autolift.org/ali-directory-of-certified-lifts/) before making your most recent Lift purchase, but did you know the **ALI Store** (www.autolift.org/ali-store/) offers a wide variety of professional, easy-to-use, and reasonably priced training and safety materials that will make your garage a safer place to work?

The ALI Store is your trusted source for workplace safety!

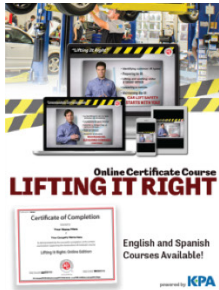

Lifting It Right Online Certificate Course. Make sure you and your people are lifting vehicles the right way.

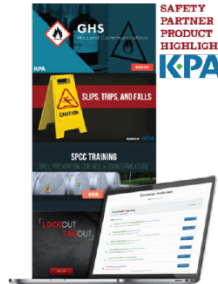

KPA Online Training Subscription. Get all of your people up to speed on automotive industry topics.

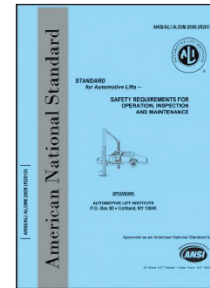

ANSI/ALI ALOIM Standard for Automotive Lifts. Safety Requirements for Operation, Inspection, and Maintenance.

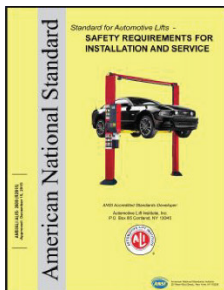

ANSI/ALI ALIS Standard. Safety Requirements for Installation and Service.

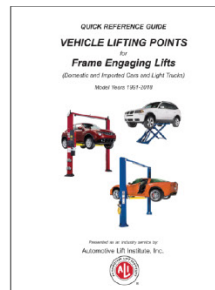

Guide to Hitting Vehicle Lifting Points for Frame-Engaging Lifts. Don't eyeball your lifting points, **know** where they are.



Lift Operator Safety Materials. Five safety documents in a single package.

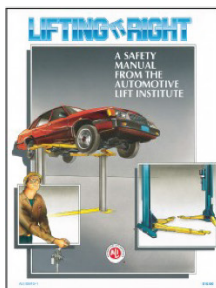

Lifting It Right. A hardcopy version of the *Lifting It Right* safety manual from the Automotive Lift Institute.



Uniform Warning Labels and Placards for 2-Posts. Labels in Mandarin, French Canadian, and Spanish are also available.



Safety Tips Card. Reminds your people of 13 key safety tips to follow daily.

Visit today and get the training and materials you need to work safely:
<http://www.autolift.org/ali-store/>



1645 Lemonwood Drive
Santa Paula, CA, 93060 USA