

XPR-10 Series Two-Post Lifts

Installation and Operation Manual

Manual P/N 5900951 — Manual Revision D — May 2019

Models:

- XPR-10S
- XPR-10AS
- XPR-10XLS
- XPR-10AXLS



Model XPR-10S shown.

Designed and engineered by BendPak Inc. in Southern California, USA. Made in China.

 **DANGER**

Read the *entire contents* of this manual *before* using this product. Failure to follow the instructions and safety precautions in this manual can result in serious injury or death. Make sure all other operators also read this manual. Keep the manual near the product for future reference. By proceeding with setup and operation, you agree that you fully understand the contents of this manual.

Manual. XPR-10 Series Two-Post Lifts, *Installation and Operation Manual*, Manual Part Number 5900951, Manual Revision D, Released May 2019.

Copyright. Copyright © 2019 by BendPak Inc. All rights reserved. You may make copies of this document if you agree that: full attribution goes to BendPak Inc., you are not authorized to make changes to the content, you do not gain any rights to this content, and you will not use the copies for commercial purposes.

Trademarks. BendPak and the BendPak logo are registered trademarks of BendPak Inc. All other company, product, and service names are used for identification only. All trademarks and registered trademarks mentioned in this manual are the property of their respective owners.

Limitations. Every effort has been made to ensure complete and accurate instructions are included in this manual. However, product updates, revisions, and/or changes may have occurred since this manual was published. BendPak reserves the right to change any information in this manual without incurring any obligation for equipment previously or subsequently sold. BendPak is not responsible for typographical errors in this manual. You can always find the latest version of the **manual for your product on the BendPak website**.

Warranty. The BendPak warranty is more than a commitment to you: it is also a commitment to the value of your new product. Contact your nearest BendPak dealer or visit www.bendpak.com/support/warranty for full warranty details. Go to bendpak.com/support/register-your-product/ and fill out the online form to register your product (be sure to click **Submit**).

Safety. Your Lift was designed and manufactured with safety in mind. Your safety also depends on proper training and thoughtful operation. Do not set up, operate, maintain, or repair the Lift without reading and understanding this manual and the labels on the unit; **do not use your Lift unless you can do so safely!**

Owner Responsibility. In order to maintain your product properly and to ensure operator safety, it is the responsibility of the product owner to read and follow these instructions:

- Follow all installation, operation, and maintenance instructions.
- Make sure product installation conforms to all applicable local, state, and federal codes, rules, and regulations, such as state and federal OSHA regulations and electrical codes.
- Read and follow all safety instructions. Keep them readily available for operators.
- Make sure all operators are properly trained, know how to safely operate the unit, and are properly supervised.
- Do not operate the product until you are certain all parts are in place and operating correctly.
- Carefully inspect the product on a regular basis and perform all maintenance as required.
- Service and maintain the unit only with approved replacement parts.
- Keep the manual with the product and make sure all labels are clean and visible.
- **Only use the Lift if it can be used safely!**

Unit Information. Enter the Model Number, Serial Number, and the Date of Manufacture from the ID label on your unit. This information is required for part or warranty issues.

Model: _____

Serial: _____

Date of Manufacture: _____

BP BendPak		Santa Paula, CA USA www.bendpak.com
MODEL NUMBER		
DESCRIPTION		
LIFT CAPACITY	DATE OF MFG.	
VOLTAGE		SERIAL NUMBER
<input type="checkbox"/> 110-240V, 50-60 Hz, 1 Ph		UPC
<input type="checkbox"/> 208-240V, 50-60 Hz, 1 Ph		
<input type="checkbox"/> 380-415V, 50-60 Hz, 3 Ph		
<input type="checkbox"/> 208-440V, 50-60 Hz, 3 Ph		
DANGER! Disconnect Power Before Servicing		
WARRANTY VOID IF DATA PLATE IS REMOVED PN 5905950		
		CE EAC

Table of Contents

Introduction	3	Operation	66
Shipping Information	3	Maintenance	72
Safety Considerations	4	Troubleshooting	74
FAQ	6	Wiring Diagrams	76
Components	7	Labels	77
Specifications	9	Parts Drawings	80
Installation Checklist	14	ALI Store	90
Installation	15	Maintenance Log	91

Introduction

This manual describes these XPR-10 Series Two-Post Lift models:

- **XPR-10S.** A Two-Post *Symmetric* Lift that raises Vehicles up to 10,000 pounds (4,536 kg). Also available with extended height (for taller Vehicles), Low-Pro™ arms, and both.
- **XPR-10AS.** A Two-Post *Asymmetric* Lift that raises Vehicles up to 10,000 pounds (4,536 kg). Also available with extended height (for taller Vehicles), Low-Pro™ arms, and both.
- **XPR-10XLS.** A Two-Post *Symmetric Lift with extended rise under the Vehicle* (for taller mechanics) that raises Vehicles up to 10,000 pounds (4,536 kg). Also available with extended height (for taller Vehicles), Low-Pro™ arms, and both.
- **XPR-10AXLS.** A Two-Post *Asymmetric Lift with extended rise under the Vehicle* (for taller mechanics) that raises Vehicles up to 10,000 pounds (4,536 kg). Also available with extended height (for taller Vehicles), Low-Pro™ arms, and both.

All models support Narrow or Wide drive-through configurations; choose the desired width configuration **before** installation based on your specific space or Vehicle width requirements. All models have Overhead Assemblies and clear floors. **All models are ALI certified.**

 **DANGER** Be very careful when installing, operating, maintaining, or repairing this equipment; failure to do so could result in property damage, product damage, injury, or (in very rare cases) death. Make sure only authorized personnel operate this equipment. All repairs must be performed by an authorized technician. Do not make modifications to the unit; this voids the warranty and increases the chances of injury or property damage. Make sure to read and follow the instructions on the labels on the unit.

More information about the full line of BendPak products is available at bendpak.com.

This manual is mandatory reading for all users of XPR-10 Series Lifts, including anyone who installs, operates, maintains, or repairs them. Keep this manual on or near the equipment at all times.

Technical support and service is available from your dealer, on the Web at bendpak.com/support, by email at techsupport@bendpak.com, or by phone at **(800) 253-2363**, extension 196.

You may also contact BendPak for parts replacement information (please have the model and serial number of your unit available) at **(800) 253-2363**, extension 191.

Shipping Information

Your equipment was carefully checked before shipping. Nevertheless, you should thoroughly inspect the shipment **before** you sign to acknowledge that you received it.

When you sign the bill of lading, it tells the carrier that the items on the invoice were received in good condition. ***Do not sign the bill of lading until after you have inspected the shipment.*** If any of the items listed on the bill of lading are missing or damaged, do not accept the shipment until the carrier makes a notation on the bill of lading that lists the missing or damaged goods.

If you discover missing or damaged goods **after** you receive the shipment and have signed the bill of lading, notify the carrier at once and request the carrier to make an inspection. If the carrier will not make an inspection, prepare a signed statement to the effect that you have notified the carrier (on a specific date) and that the carrier has failed to comply with your request.

It is difficult to collect for loss or damage after you have given the carrier a signed bill of lading. If this happens to you, file a claim with the carrier promptly. Support your claim with copies of the bill of lading, freight bill, invoice, and photographs, if available. Our willingness to assist in helping you process your claim does not make us responsible for collection of claims or replacement of lost or damaged materials.

Safety Considerations

Read this entire manual carefully before using your new product. Do not install or operate the product until you are familiar with all operating instructions and warnings. Do not allow anyone else to operate the product until they are familiar with all operating instructions and warnings.

Safety Information

Please note the following:

- XPR-10 Series Lifts are two-post service Lifts. ***Use them only for their intended purpose.***
- Only operate your Lift between temperatures of 41°F to 104°F (5°C to 40°C).
- The Lift should only be operated by authorized personnel. Keep children and untrained personnel away from the Lift.
- Do not make any modifications to the Lift; this voids the warranty and increases the chances of injury or property damage.
- Do not use the Lift while tired or under the influence of drugs, alcohol, or medication.
- Make sure all operators read and understand this *Installation and Operation Manual*. Keep the manual near the Lift at all times.

-
- Make a visual inspection of the Lift before using it. Do not use the Lift if you find any missing or damaged parts. Instead, take it out of service, then contact an authorized repair facility, your distributor, or BendPak at **(805) 933-9970** or techsupport@bendpak.com.
 - BendPak recommends making a **thorough** inspection of the Lift at least once a year. Replace any damaged or severely worn parts, decals, or warning labels.

Symbols

Following are the symbols used in this manual:



DANGER

Calls attention to a hazard that **will** result in death or injury.



WARNING

Calls attention to a hazard or unsafe practice that **could** result in death or injury.



CAUTION

Calls attention to a hazard or unsafe practice that could result in personal injury, product damage, or property damage.

NOTICE

Calls attention to a situation that could result in product or property damage.



Tip

Calls attention to information that can help you use your unit better.

Liability Information

BendPak assumes **no** liability for damages resulting from:

- Use of the equipment for purposes other than those described in this manual.
- Modifications to the equipment without prior, written permission from BendPak.
- Damage to the equipment from external influences.
- Incorrect operation of the equipment.

Electrical Information



DANGER

All wiring **must** be performed by a licensed, certified Electrician. Do not perform any maintenance until main electrical power has been disconnected from the Lift and cannot be re-energized until all procedures are complete.

Important electrical information:

- Improper electrical installation can damage the Power Unit motor, which is not covered by the warranty.
- The Lift uses electrical energy; if your organization has Lockout/Tagout policies, make sure to implement them after connecting to a power source.
- Use a separate circuit breaker for each Power Unit.
- Protect each circuit with a time delay fuse or circuit breaker:
 - For a 208 to 230 VAC, **single phase** circuit, use a 25 amp fuse.
 - For a 208 to 230 VAC, **three phase** circuit, use a 20 amp fuse.
 - For a 380 to 440 VAC, **three phase** circuit, use a 15 amp fuse.

Frequently Asked Questions

Question: What kinds of Vehicles can I raise on my XPR-10 Series Lift?

Answer: Cars, trucks, SUVs, and so on; up to 10,000 lbs (4,536 kg) each.

Q: How long will it take to raise or lower my Vehicle?

A: Anywhere from 30 to 45 seconds, depending on how high you raise it.

Q: Does the Lift have to be anchored in place?

A: Yes. Two-Post Lifts **must** be anchored. Your Lift comes with high-quality, Automotive Lift Institute-certified Anchor Bolts; use only the Anchor Bolts that came with your Lift.

Q: How thick does my Concrete have to be?

A: 4.25 inches thick, 3,000 PSI, cured for a minimum of 28 days. Do not install the Lift on cracked or defective Concrete. **Do not install on asphalt or any surface other than Concrete.**

Q: Can I install my Lift outside?

A: No. All XPR-10 Series Lifts are approved for indoor installation and use only.

Q: How long can I leave a Vehicle raised up on my Lift?

A: For a long time, as long as you leave the Lift *engaged* on its Safety Locks. Once the Lift is engaged on its Safety Locks, gravity holds it in position. **Only leave your Lift either on the ground (fully lowered) or engaged on its Safety Locks.**

Q: How many Safety Lock positions does my Lift have?

A: Fourteen, spaced every 3 inches.

Q: Does the Lift have a Front and Rear?

A: Yes and no. Because you can drive onto a two-post Lift from either opening, there is technically no Front and Rear. However, most garages have an Approach side and a Wall side, so in that case, the Wall side is the Front and the Approach side is the Rear. If you have an Asymmetric Lift, the 30° angle faces the Rear of the Lift, so the other end is the Front.

Q: What is the difference between a Symmetric and an Asymmetric Lift?

A: The Bases of Symmetric Lifts face each other directly and when a Vehicle is on the Lift, it is more or less balanced; the same amount of weight on either side of an imaginary line drawn between the Posts. The Bases of Asymmetric Lifts are angled 30 degrees towards the Approach, making it easier to open the doors of some Vehicles. When a Vehicle is on an Asymmetric Lift, about 30 percent of the weight is in front of the Posts and about 70 percent is behind the Posts.

Q: Are Vehicles on an Asymmetric Lift balanced?

A: Yes. Even though Asymmetric Lifts are angled, the Arms are positioned such that the Vehicle is still balanced when raised on the Lift.

Q: How do I know where to put the Adapters when I want to raise a Vehicle?

A: The Vehicle needs to be balanced, so you must put the Adapters (sometimes called Pads) so that they contact the manufacturer's recommended Lifting Points. **If you do not know where the manufacturer's recommended Lifting Points are on a Vehicle, you must find out before you raise it.** Your Lift came with books that will help: *Vehicle Lifting Points for Frame Engaging Lifts* shows the Lifting Points for hundreds of Vehicles. *Lifting It Right* includes information about how to raise Vehicles correctly.

Components

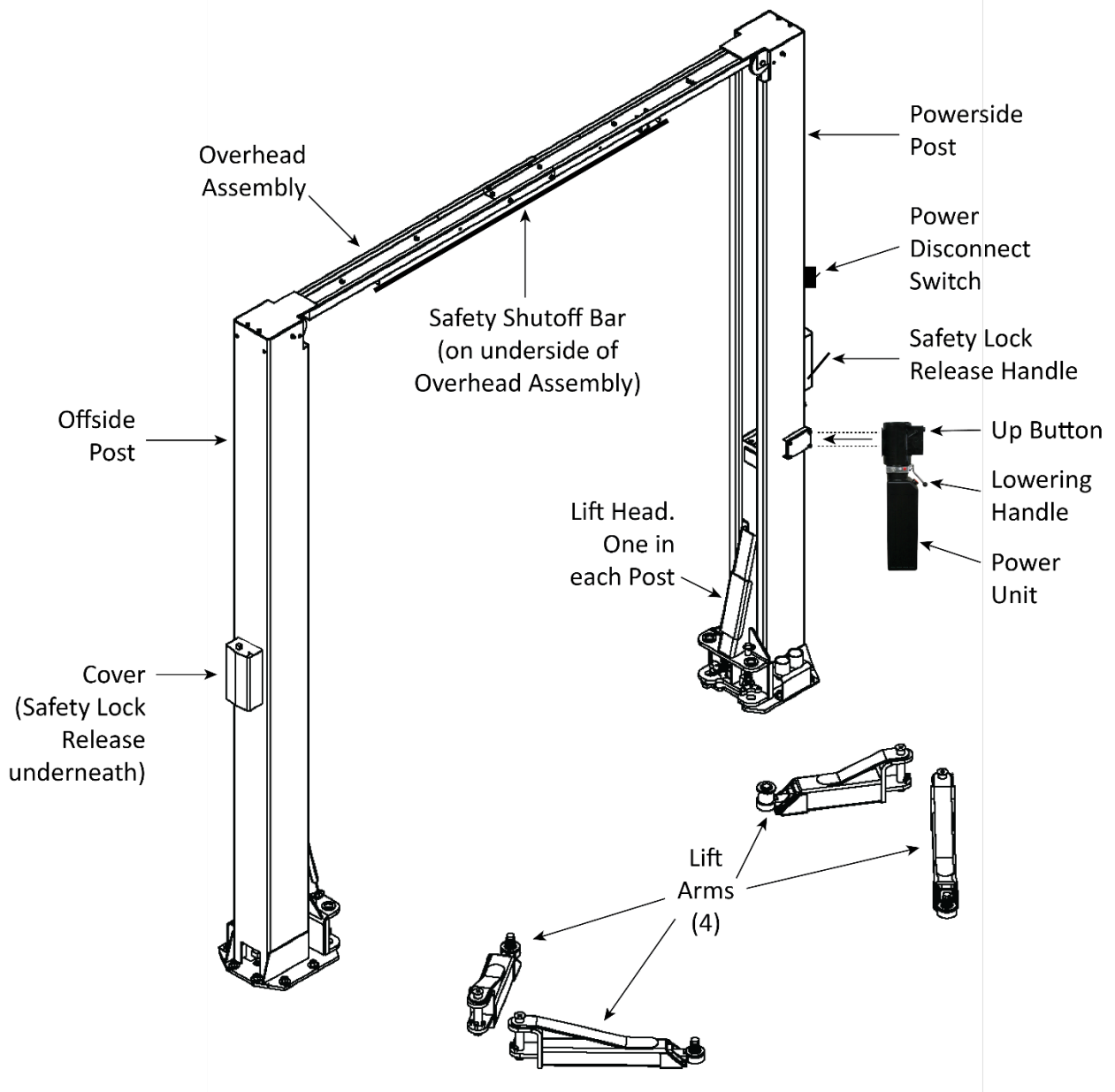

Symmetric model shown. Not all components shown. Powerside Post shown on the right. Models with extension pieces are taller. Asymmetric models are angled 30° towards the Approach side.

XPR-10 Series Lift components include:

- **Powerside Post:** The Powerside Post holds the Power Unit, the Safety Lock Release Handle, the Lowering Handle (which is on the Power Unit), and the Power Disconnect Switch. The Powerside Post must be on the Right (looking at the Lift from the Approach) for Asymmetric models; it can be on the Left or the Right for Symmetric models.
- **Offside Post:** The other Post.
- **Power Unit:** Provides Hydraulic Fluid to the Lift and connects to an appropriate power source. Includes the Up Button, the Lowering Handle, and the Hydraulic Fluid reservoir.
- **Up Button:** Press and hold to raise the Vehicle on the Lift.
- **Safety Lock Release Handle:** Located on the Power Post above the Power Unit, it disengages the Safety Locks so you can lower the Lift.
- **Lowering Handle:** Lowers the Lift when used at the same time as the Safety Lock Release Handle. Located on the Power Unit.
- **Power Disconnect Switch:** Immediately interrupts main electrical power to the Lift. Used for electrical circuit faults, emergency situations, or when Lift is undergoing service or maintenance.
- **Lift Heads:** Sometimes called carriages. Lift Heads move up and down in the Posts. They connect to the Lift Arms, so when the Lift Heads move up, the Lift Arms also move up, thus raising any Vehicle on the Lift Arms.
- **Lift Arms:** Extendable steel arms that attach to the Lift Heads. Adapters (also called Pads) attach at the end of each Lift Arm; they contact the Lifting Points on the underside of the Vehicle.
- **Adapters:** Pads that contact the Lifting Points on the underside of the Vehicles you raise. Four Screw Lift Adapters are included with your Lift, as are a set of four Auxiliary Adapters that can be used with the Screw Lift Adapters to add an additional 2.5 inches of height (to make better contact with the Lifting Points on some Vehicles).

Frame Cradle Pads, which are well-suited for raising and holding trucks and SUVs (body-on-frame style), are available separately.

- **Safety Locks:** Hold the Lift Heads up when engaged. Multiple Safety Lock heights let you select the best one for your needs. Once engaged on its Safety Locks, the Lift Heads stay up, even if the Lift loses power. ***Only leave your Lift fully lowered or engaged on Safety Locks.***

Safety Locks are pretty well hidden by the Posts, but you can hear them as the Lift rises. Refer to [About Safety Locks](#) for more information.

- **Overhead Assembly:** The steel beam that sits between the tops of the two Posts, it supports the Lift's structure, holds Cables and Hydraulic Lines, and can be set to Wide or Narrow drive-through Configurations during installation.
- **Safety Shutoff Bar:** Located on the underside of the Overhead Assembly, the Safety Shutoff Bar stops upward movement of the Lift if the top of a Vehicle hits it.
- **Equalizing Cables:** Two cables that keep the Lift Heads synchronized. You do not want one Lift Head lowering or raising faster than the other Lift Head; the Equalizing Cables keep them synchronized. For Symmetric Lifts, the two Equalizing Cables are the same length; for Asymmetric Lifts, the two Equalizing Cables are different lengths.

Specifications

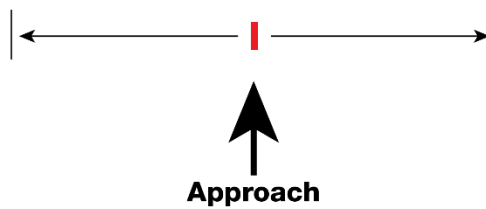
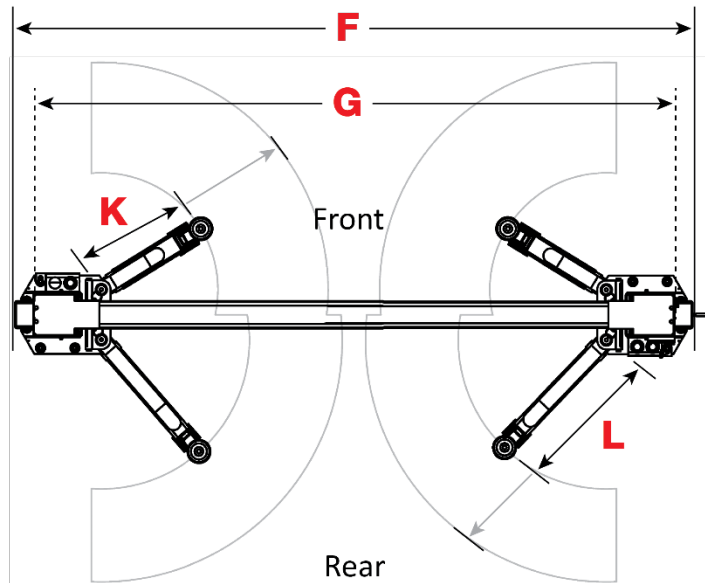
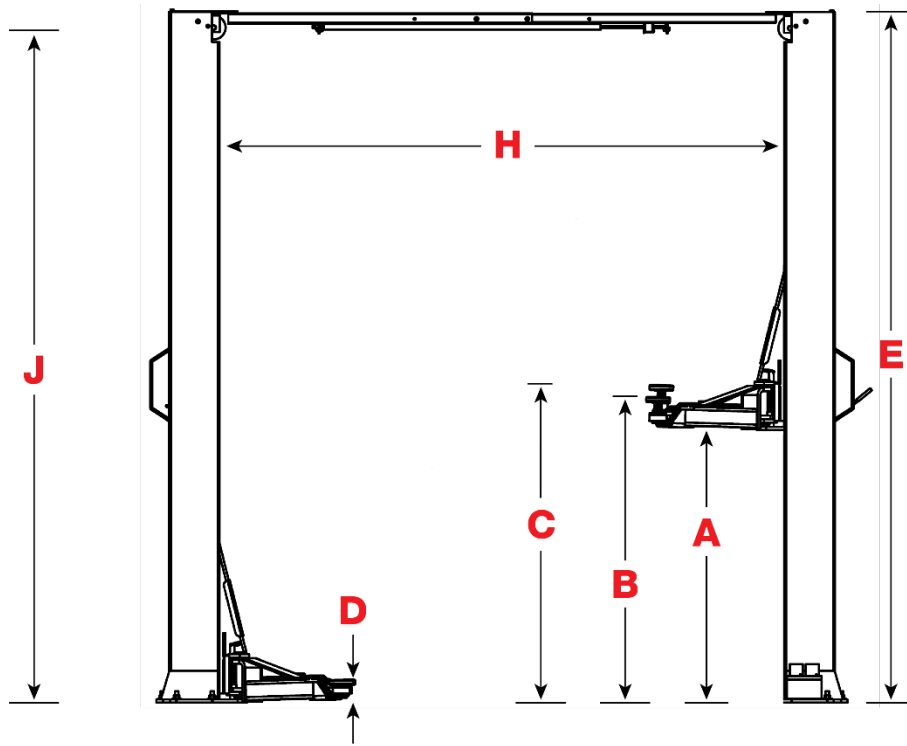

Model	XPR-10S / -LP	XPR-10S-168 / -168-LP
Lifting Capacity	10,000 lbs / 4,536 kg	
Maximum Capacity Front Axle	5,000 / 2,268 kg	
Maximum Capacity Rear Axle	5,000 / 2,268 kg	
A – Rise	69" / 1,753 mm	
B – Lifting Height w/Pad*	73.75" / 1,873 mm	
C - Maximum Lifting Height*	78.5" / 1,991 mm	
D – Minimum Height w/Pad	4.75" / 120 mm	
E – Height Overall	144.75" / 3,678 mm	168.75" / 4,284 mm
F – Width Overall (Narrow)	132" / 3,353 mm	
F – Width Overall (Wide)	145" / 3,683 mm	
G – Outside Posts (Narrow)	126.75" / 3,219 mm	
G – Outside Posts (Wide)	139.75" / 3,549 mm	
H – Inside Posts (Narrow)	105.5" / 2,679 mm	
H – Inside Posts (Wide)	118.5" / 3,009 mm	
I – Drive-Thru Width (Narrow)	93" / 2,364 mm	
I – Drive-Thru Width (Wide)	106" / 2,694 mm	
J – Floor to Top Switch	140.75" / 3,576 mm	164.75" / 4,182 mm
K – Front Arm Reach (min)	25.5" / 646 mm	
K – Front Arm Reach (max)	49.5" / 1,255 mm	
L – Rear Arm Reach (min)	32.25" / 820 mm	
L – Rear Arm Reach (max)	52.5" / 1,333 mm	
Motor	220 VAC, 60 Hz, 1 Phase	
Time to Full Rise	~45 seconds	
Maximum Hydraulic Pressure	2500	
Sound	<70 dB	

* *Lifting Height w/Pad* is maximum lifting height with Pads at lowest height, no adapter. *Maximum Lifting Height* is maximum lifting height with Pads at top height and with the 2.5" / 63 mm Adapter.

Specifications subject to change without notice.

Model	XPR-10AS / -LP	XPR-10AS-168 / -168-LP
Lifting capacity	10,000 lbs / 4,536 kg	
Maximum Capacity Front Axle	5,000 / 2,268 kg	
Maximum Capacity Rear Axle	5,000 / 2,268 kg	
A – Rise	69" / 1,753 mm	
B – Lifting Height w/Pad*	73.75" / 1,872 mm	
C - Maximum Lifting Height*	78.25" / 1,990 mm	
D – Minimum Height w/Pad	4.75" / 119 mm	
E – Height Overall	144.75" / 3,678 mm	168.75" / 4,284 mm
F – Width Overall (narrow)	137" / 3,480 mm	
F – Width Overall (wide)	145" / 3,684 mm	
G – Outside Posts (narrow)	133.25" / 3,386 mm	
G – Outside Posts (wide)	141.25" / 3,590 mm	
H – Inside Posts (narrow)	106.25" / 2,700 mm	
H – Inside Posts (wide)	114.25" / 2,903 mm	
I – Drive-Thru Width (narrow)	93.75" / 2,382 mm	
I – Drive-Thru Width (wide)	101.75" / 2,585 mm	
J – Floor to Top Switch	140" / 3,558 mm	164" / 4,164 mm
K – Front Arm Reach (min)	23.5" / 595 mm	
K – Front Arm Reach (max)	43.75" / 1,110 mm	
L – Rear Arm Reach (min)	40.25" / 1,024 mm	
L – Rear Arm Reach (max)	58" / 1,474 mm	
Motor	220 VAC, 60 Hz, 1 Phase	
Time to Full Rise	~45 seconds	
Maximum hydraulic pressure	2500	
Sound	<70 dB	

* *Lifting Height w/Pad* is maximum lifting height with Pads at lowest height, no adapter. *Maximum Lifting Height* is maximum lifting height with Pads at top height and with the 2.5" / 63 mm adapter.

Specifications subject to change without notice.

Model	XPR-10XLS / -LP	XPR-10XLS-168 / -168-LP
Lifting capacity	10,000 lbs / 4,536 kg	
Maximum Capacity Front Axle	5,000 / 2,268 kg	
Maximum Capacity Rear Axle	5,000 / 2,268 kg	
A – Rise	75" / 1,905 mm	
B – Lifting Height w/Pad*	79.75" / 2,025 mm	
C - Maximum Lifting Height*	84.5" / 2,143 mm	
D – Minimum Height w/Pad	4.75" / 120 mm	
E – Height Overall	156.75" / 3,983 mm	180.75" / 4,589 mm
F – Width Overall (narrow)	132" / 3,353 mm	
F – Width Overall (wide)	145" / 3,683 mm	
G – Outside Posts (narrow)	126.75" / 3,219 mm	
G – Outside Posts (wide)	139.75" / 3,549 mm	
H – Inside Posts (narrow)	105.5" / 2,679 mm	
H – Inside Posts (wide)	118.5" / 3,009 mm	
I – Drive-Thru Width (narrow)	93" / 2,364 mm	
I – Drive-Thru Width (wide)	106" / 2,694 mm	
J – Floor to Top Switch	152" / 3,863 mm	176" / 4,469 mm
K – Front Arm Reach (min)	25.5" / 646 mm	
K – Front Arm Reach (max)	49.5" / 1,255 mm	
L – Rear Arm Reach (min)	32.25" / 820 mm	
L – Rear Arm Reach (max)	52.5" / 1,333 mm	
Motor	220 VAC, 60 Hz, 1 Phase	
Time to Full Rise	~45 seconds	
Maximum hydraulic pressure	2500	
Sound	<70 dB	

* *Lifting Height w/Pad* is maximum lifting height with Pads at lowest height, no adapter. *Maximum Lifting Height* is maximum lifting height with Pads at top height and with the 2.5" / 63 mm adapter.

Specifications subject to change without notice.

Model	XPR-10AXLS / -LP	XPR-10AXLS-168 / -168-LP
Lifting capacity	10,000 lbs / 4,536 kg	
Maximum Capacity Front Axle	5,000 / 2,268 kg	
Maximum Capacity Rear Axle	5,000 / 2,268 kg	
A – Rise	75" / 1,905 mm	
B – Lifting Height w/Pad*	79.75" / 2,025 mm	
C - Maximum Lifting Height*	84.25" / 2,143 mm	
D – Minimum Height w/Pad	4.75" / 119 mm	
E – Height Overall	156.75" / 3,983 mm	180" / 4,573 mm
F – Width Overall (narrow)	137" / 3,480 mm	
F – Width Overall (wide)	145" / 3,684 mm	
G – Outside Posts (narrow)	133.25" / 3,386 mm	
G – Outside Posts (wide)	141.25" / 3,590 mm	
H – Inside Posts (narrow)	106.25" / 2,700 mm	
H – Inside Posts (wide)	114.25" / 2,903 mm	
I – Drive-Thru Width (narrow)	93.75" / 2,382 mm	
I – Drive-Thru Width (wide)	101.75" / 2,585 mm	
J – Floor to Top Switch	152" / 3,863 mm	175.25" / 4,453 mm
K – Front Arm Reach (min)	23.5" / 595 mm	
K – Front Arm Reach (max)	43.75" / 1,110 mm	
L – Rear Arm Reach (min)	40.25" / 1,024 mm	
L – Rear Arm Reach (max)	58" / 1,474 mm	
Motor	220 VAC, 60 Hz, 1 Phase	
Time to Full Rise	~45 seconds	
Maximum hydraulic pressure	2500	
Sound	<70 dB	

* *Lifting Height w/Pad* is maximum lifting height with Pads at lowest height, no adapter. *Maximum Lifting Height* is maximum lifting height with Pads at top height and with the 2.5" / 63 mm adapter.

Specifications subject to change without notice.

Installation Checklist

Following are the steps needed to install an XPR-10 Series Lift; perform them in this order.

- 1. Review the Safety Rules.
- 2. Plan for Electrical work.
- 3. Make sure you have the necessary Tools.
- 4. Review the Installation Orientation.
- 5. Review Clearances around the Lift.
- 6. Select the Installation Location.
- 7. Choose a Wide or Narrow Configuration (***do not proceed until you have chosen***).
- 8. Put Equalizing Cables into position.
- 9. Add Extension Pieces for models with extensions.
- 10. Put Hydraulic Lines into position.
- 11. Create Chalk Line Guides for the Posts.
- 12. Install the Posts.
- 13. Prepare and install the Overhead Assembly, Safety Shutoff Bar, and the Microswitch.
- 14. Install the Equalizing Cables.
- 15. Route the Safety Lock Cable.
- 16. Mount the Power Unit (*do not connect it yet*).
- 17. Install the Safety Assemblies and the Safety Lock Cable.
- 18. Connect the Hydraulic Lines.
- 19. Learn about Arm Restraint Gears.
- 20. Install the Lift Arms.
- 21. Perform final Leveling.
- 22. Contact the Electrician.
- 23. Wire the Microswitch (***requires an Electrician***).
- 24. Connect the Power Unit (***requires an Electrician***).
- 25. Install the Power Disconnect Switch (***requires an Electrician***).
- 26. Install the Thermal Disconnect Switch (***requires an Electrician***).
- 27. Install the Safety Covers.
- 28. Lubricate the Lift.
- 29. Perform an Operational Test.
- 30. Review the final Checklist.
- 31. Leave the Manual with the owner/operator.

Installation

The installation process includes multiple steps. Perform them in the order listed.

Reviewing the Safety Rules

When installing a Lift, your safety depends on proper training and thoughtful operation.

 **WARNING** Do not install this equipment unless you have automotive lift installation training. Always use proper lifting tools, such as a Forklift or Shop Crane, to raise heavy components. Do not install this equipment without reading and understanding this Manual and the Labels on the unit.

Only fully trained personnel should be involved in installing this equipment. Pay attention at all times. Use appropriate tools and lifting equipment. Stay clear of moving parts.

 **WARNING** You must wear appropriate protective equipment at all times during installation: leather gloves, steel-toed work boots, eye protection, back belts, and hearing protection.

Preparing for Electrical Work

You will need to have a licensed, certified Electrician available at some point during the installation.

 **DANGER** All wiring *must* be performed by a licensed, certified Electrician.

Make sure all electrical work conforms to applicable local, state, and federal codes, rules, and regulations, such as state and federal OSHA regulations and electrical codes.

Notify your Electrician in advance so they come prepared with the items required to connect to the facility's power system or an appropriate power cord with plug for connecting to an appropriate power source, a Power Disconnect Switch, and a Thermal Disconnect Switch. These items are *not* supplied with the Lift.

The Electrician needs to:

- **Connect to power.** The Power Unit comes with a pigtail for wiring to a power source. Have your Electrician connect a power cord with plug to the electrical box on the Lift (for connection to a power outlet) or have them wire it directly into the electrical system at the Lift location.

Note that *installing* the Power Unit and *connecting* the Power Unit to a power source are separate procedures and are done at different times in the installation process. You do *not* need an Electrician to *install* the Power Unit, but an Electrician is *required* to *connect* the Power Unit to the power source.

- **Connect the Microswitch wiring to the Power Unit.** The Microswitch has to be wired to the Power Unit. The necessary wiring is included with the Lift.
- **Install a Power Disconnect Switch.** A Power Disconnect Switch is used to shut down the Lift in the event of an electrical circuit fault, emergency situation, or when the Lift is being serviced. Refer to [Installing a Power Disconnect Switch](#) for more information.
- **Install a Thermal Disconnect Switch.** A Thermal Disconnect Switch automatically shuts down the equipment in the event of an overload or an overheated motor. Refer to [Installing a Thermal Disconnect Switch](#) for more information.

Gathering Your Tools

You may need some or all of the following tools:

- Rotary hammer drill (or similar)
- ¾ inch carbide bit (conforming to ANSI B212.15-1994)
- Hammer
- Four-foot level
- Open-end wrench set, SAE and metric
- Socket and ratchet set, SAE and metric
- Hex key wrench set
- Crescent and pipe wrenches
- Torque wrench
- Crow bar
- Chalk line
- Medium-sized flat screwdriver
- Tape measure, 25 feet or more
- Needle-nose pliers
- Forklift or Shop Crane
- Two 12-foot ladders
- Two saw horses

Checking the Installation Orientation

Keep these factors in mind when deciding how you are going to orient the Lift:

- The first thing to figure out is which direction you will be driving the Vehicles in, called the Approach.

In some cases, this is very easy: there's a driveway on one side and a wall on the other side. The driveway is your Approach. This makes the wall side the Front of the Lift and the driveway side the Rear of the Lift.

If both sides are open, decide which way you will be driving the Vehicles onto the Lift. This is the Approach. The drive-**on** side is the Rear of the Lift and the drive-**off** side is the Front.

Designating Front and Rear is important because the shorter Lift Arms go on the Front of the Lift and the longer Lift Arms go on the Rear.

To determine the Front of your Lift, drive a Vehicle straight in (do not back it in) and stop. The Front of the Lift is where the Front of the Vehicle is.

- The Power Unit must go on the Powerside Post. You can identify the Powerside Post by the Mounting Bracket to which the Power Unit attaches; only one Post that came with your Lift has a Mounting Bracket.

- If you are installing a Symmetric model, the Powerside Post can go on either side as you are looking at the Lift. Put the Post with the Mounting Bracket on the side you want, no other changes are necessary. How do you make this decision? One factor is: where is the power source—you generally want the power source as close as possible to the Power Unit. Otherwise, pick the side that works best for the site and/or get the opinion of the Lift owner.

XPR-10 Series, Symmetric Models

Power Unit can go at either X.

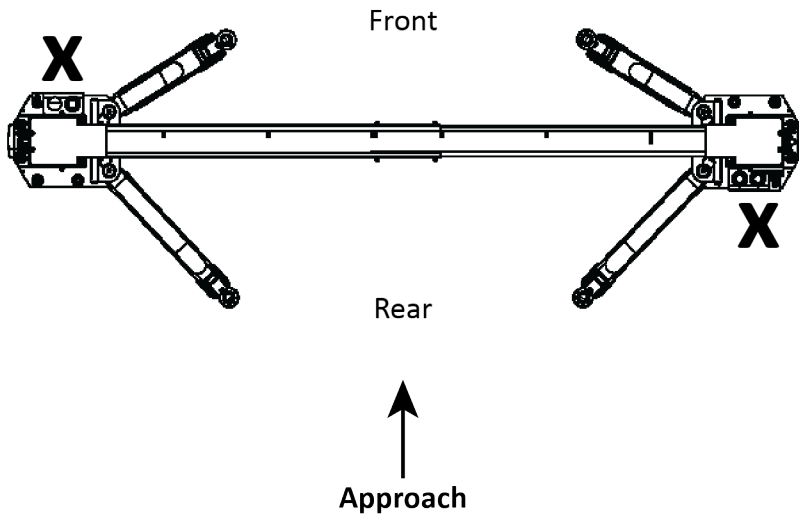

- If you are installing an Asymmetric Lift, the Powerside Post and the Power Unit must go on the right. The 30 degree angles of the Posts of an Asymmetric Lift must face the Rear of the Lift.

XPR-10 Series, Asymmetric Models

Power Unit must go at X.

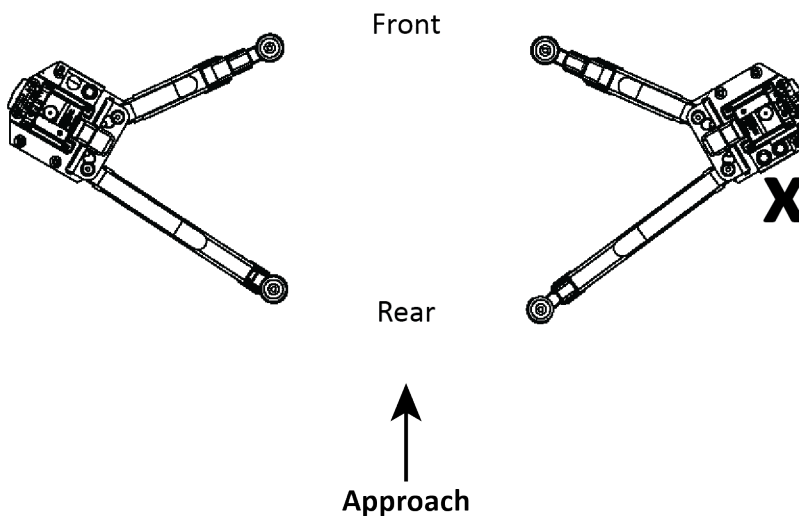

Checking Clearances

For safety purposes, a specified amount of clear space around the Lift is **required**.

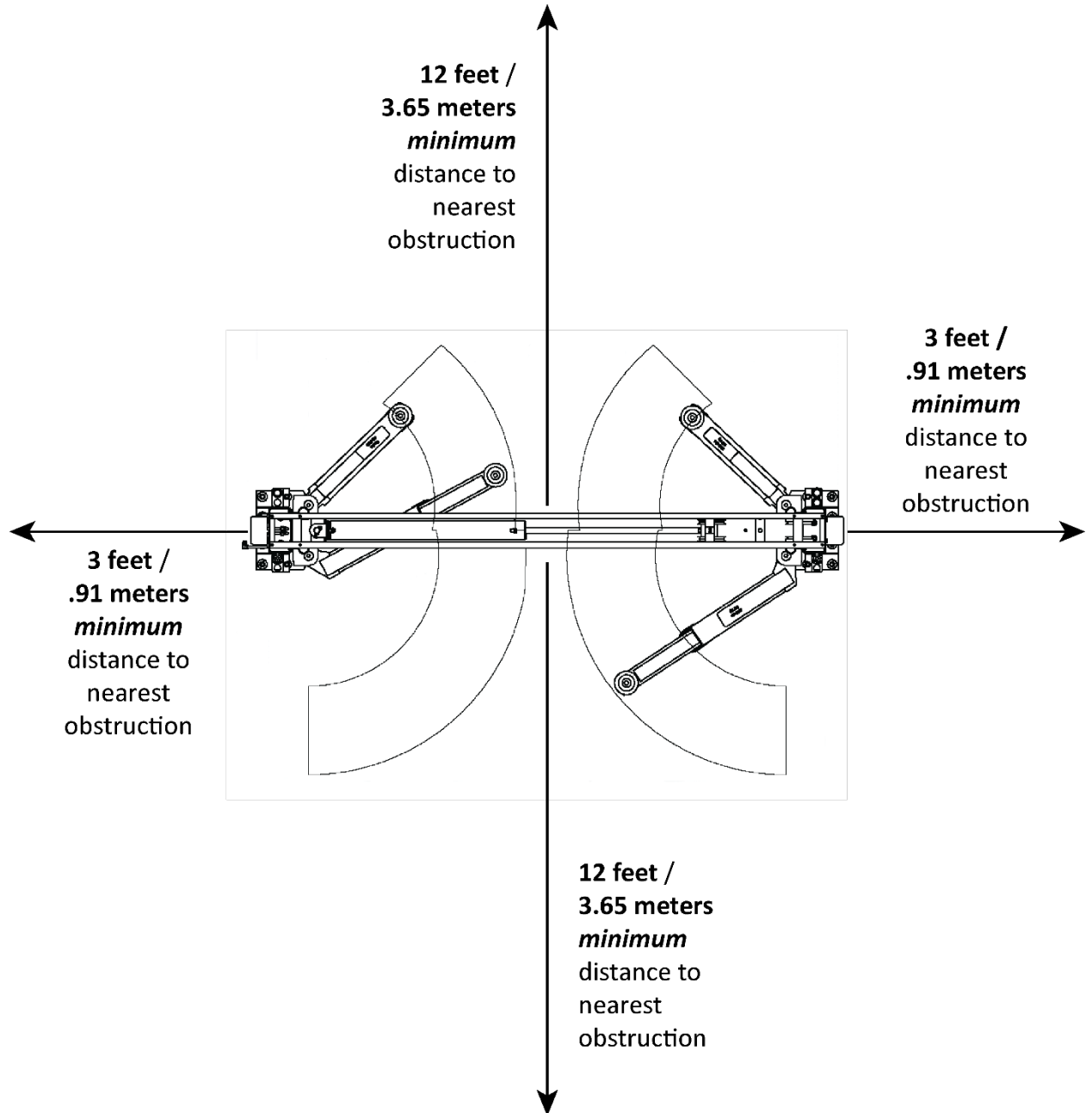

Drawing is a top view. Not necessarily to scale. Not all components shown. Additional distance is required for the Front and Rear as Vehicles can be driven in or driven off from these directions.

Selecting a Location

When selecting the location for your Lift, consider:

- **Architectural plans.** Consult the architectural plans for the desired location. Make sure there are no contradictions between what you want to do and what the plans show.
- **Available space.** Make sure there is enough space for the Lift: front, back, sides, and **above**. Refer to **Specifications** for exact measurements.
- **Symmetric or Asymmetric.** Asymmetric models can be installed with the Front a little closer to a wall, as only 30 percent of the length of the Vehicles will be in Front of the Posts.
- **Overhead obstructions.** Check for overhead obstructions such as building supports, heaters, lights, electrical lines, low ceilings, and so on.
- **Power.** You need an appropriate power source for the Lift's Power Unit.
- **Outdoor installations.** XPR-10 Series Lifts are approved for **indoor installation and use only**. *Outdoor installation is prohibited.*
- **Floor.** Only install the Lift on a flat, concrete floor; do not install on asphalt or any other surface. The surface must be level; do not install if the surface has more than three degrees of slope.

 **WARNING** Installing your Lift on a surface with more than three degrees of slope could lead to injury or even death. Only install your Lift on a level floor (defined as no more than 3/8 of an inch difference over the installation area). If your floor is not level, consider making the floor level or using a different location.

- **Concrete specifications.** Make sure the concrete is at least 4.25 inches thick, 3,000 PSI, and cured for a minimum of 28 days. Do not install the Lift on cracked or defective concrete. Anchor Bolts must be more than 6 inches from cracks in the concrete or from a wall.

 **CAUTION** BendPak Lifts are supplied with installation instructions and concrete anchors that meet the criteria set by the American National Standard "Automotive Lifts – Safety Requirements for Construction, Testing, and Validation", ANSI/ALI ALCTV-2011. Consult with an expert for any special regional structural and/or seismic anchoring requirements specified by any other agencies and/or codes such as the Uniform Building Code (UBC) and/or International Building Code (IBC).

Check your floor for the possibility of it being a post-tension slab. In this case, contact the building architect **before** drilling. Using ground penetrating radar may help you find tensioned steel.

 **WARNING** Cutting through a tensioned cable can result in injury or death. Do not drill into a post-tension slab unless the building architect confirms you are **not** going to hit tensioned steel or you have located it using ground penetrating radar. ***If colored sheath comes up during drilling, stop drilling immediately.***

- **Unloading the components.** Unload the Lift components as close to the installation location as possible. The Lift includes a number of heavy pieces, so the closer you unload them to the installation location, the better off you will be.

 **WARNING** Some Lift components are very heavy; if handled incorrectly, they can damage materials like tile, sandstone, and brick. Try to handle the Lift components just twice: once when delivered and once when moved into position. You must have a Forklift or Shop Crane to move some of the Lift components into position. ***Use care when moving Lift components.***

Choosing a Wide or Narrow Configuration

XPR-10 Series Lifts can be installed in a Wide or Narrow Configuration:

- **Wide Configuration.** The Posts are further apart, which means you can raise wider Vehicles on the Lift. This is usually the best choice *if* your Lift location is wide enough to support it. When installing the Equalizing Cables, use the Button End at the very end of the cable.



- **Narrow Configuration.** The Posts are closer together. This is usually the best choice for narrower garages, as it uses less width. When you are installing the Equalizing Cables, use the Button End *away* from the end of the cable.

Important: XPR-10 Series Lifts are shipped from the factory with the Overhead Assembly and the Safety Shutoff Bar *already configured in the Narrow Configuration*. Refer to [Installing the Overhead Assembly, Safety Shutoff Bar, and the Microswitch](#) for information about switching to the Wide Configuration.

You do not need to do anything to the Overhead Assembly at this point, but you have to **decide** on a Wide or Narrow Configuration **now** for two reasons:

- **Routing the Equalizing Cables.** The Equalizing Cables come with two Button ends, one for the Wide Configuration and one for the Narrow Configuration. *You need to know which Button end to use when you put the Equalizing Cables into position.*
- **Creating the Chalk Line Guides.** You use the Width Overall setting (in [Specifications](#)) to create the Chalk Line Guides, so you know how far apart to put your Posts. There are two Width Overall settings, one for the Wide Configuration and one for the Narrow Configuration. You need to know which one to use when you are creating your Chalk Line Guides.

If you are installing a Lift and do not yet know if it is going to be a Wide or a Narrow Configuration, you need to **figure it out now**, before you go any further in the installation process.

Putting Equalizing Cables into Position

It is much easier to put the Equalizing Cables into position **before** you stand up the Posts. Note that this is **not a full install** of the Equalizing Cables, just putting them into position.

⚠ CAUTION BendPak recommends wearing gloves while handling the Equalizing Cables.

The Equalizing Cables keep the Lift Heads synchronized. You do not want one Lift Head lowering or raising faster than the other Lift Head; the Vehicle on the Lift would become unstable and could fall.

The following drawing shows an Equalizing Cable; the ends are exaggerated for clarity.

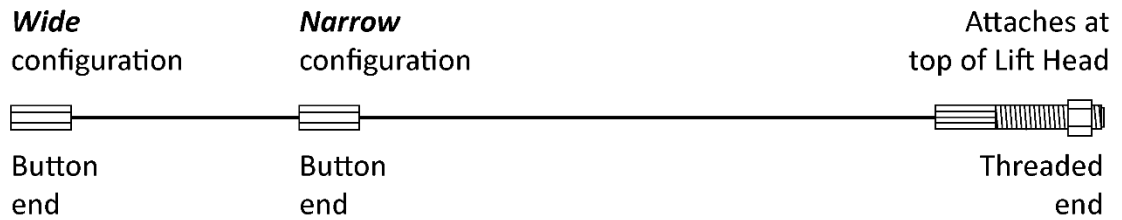

Important: For Symmetric models, the two Equalizing Cables are the same length. **For Asymmetric models, the two Equalizing Cables are different lengths.** For Asymmetric models, the longer cable is routed over the Overhead Assembly Sheaves on the Approach side of the Lift (the Overhead Assembly Sheaves that are furthest apart from each other).

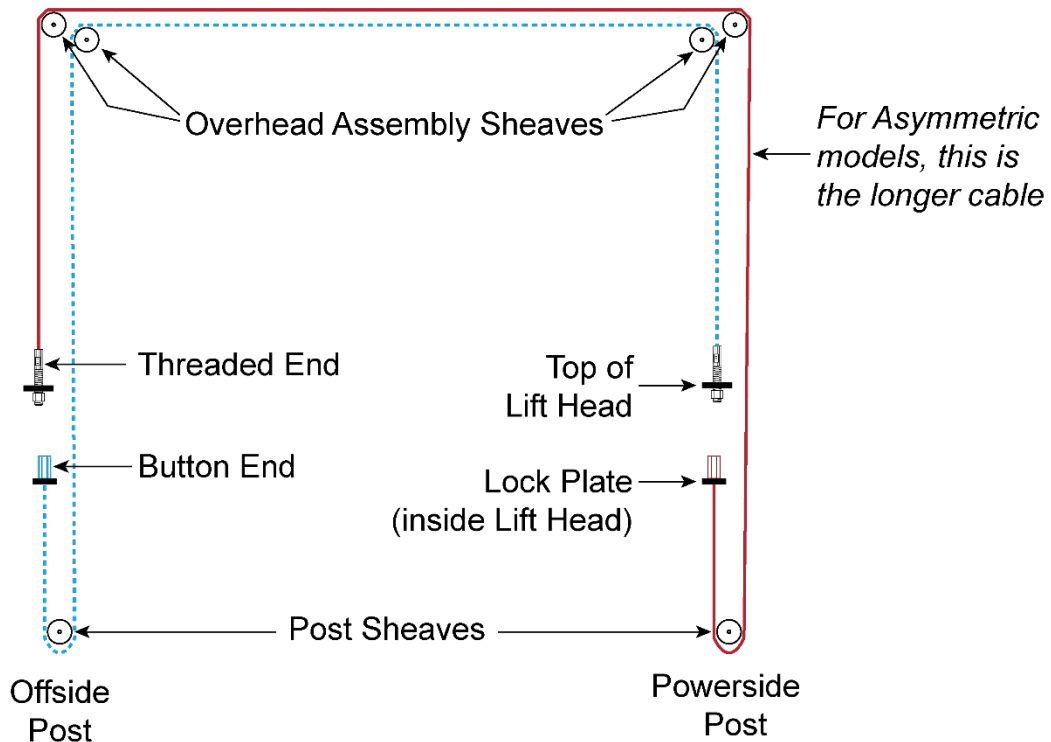

Not necessarily to scale. Not all components shown. Some components exaggerated for clarity. Asymmetric model shown, so one cable is longer than the other.

The following procedure puts the two Equalizing Cables into place at the bottom of the Post; *it is not a full install of the Equalizing Cables.*

To put the Equalizing Cables into position:

1. Put both Posts either flat on the ground or mostly on the ground with their tops elevated on a sawhorse or similar.

The ***insides*** of the Posts need to be accessible, facing up.

2. Slide the Lift Heads away from the bottoms of both Posts by at least 24 inches / 610 mm, to give yourself some space to work.

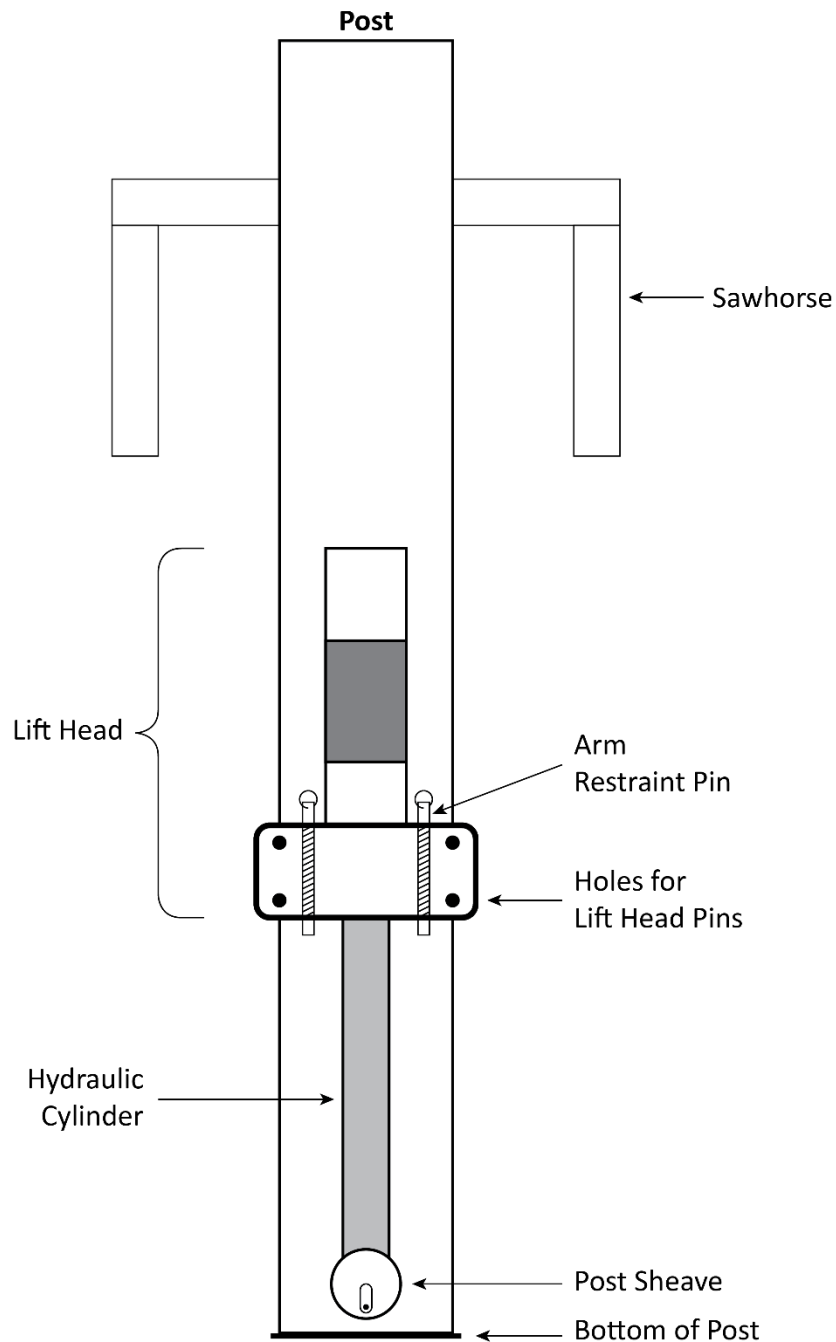

Not necessarily to scale. Not all components shown. Top view looking at inside of Post. Equalizing Cables not yet in place.

3. Look at the inside of the Lift Head you just moved, from the bottom looking towards the top — it looks something like the following drawing.

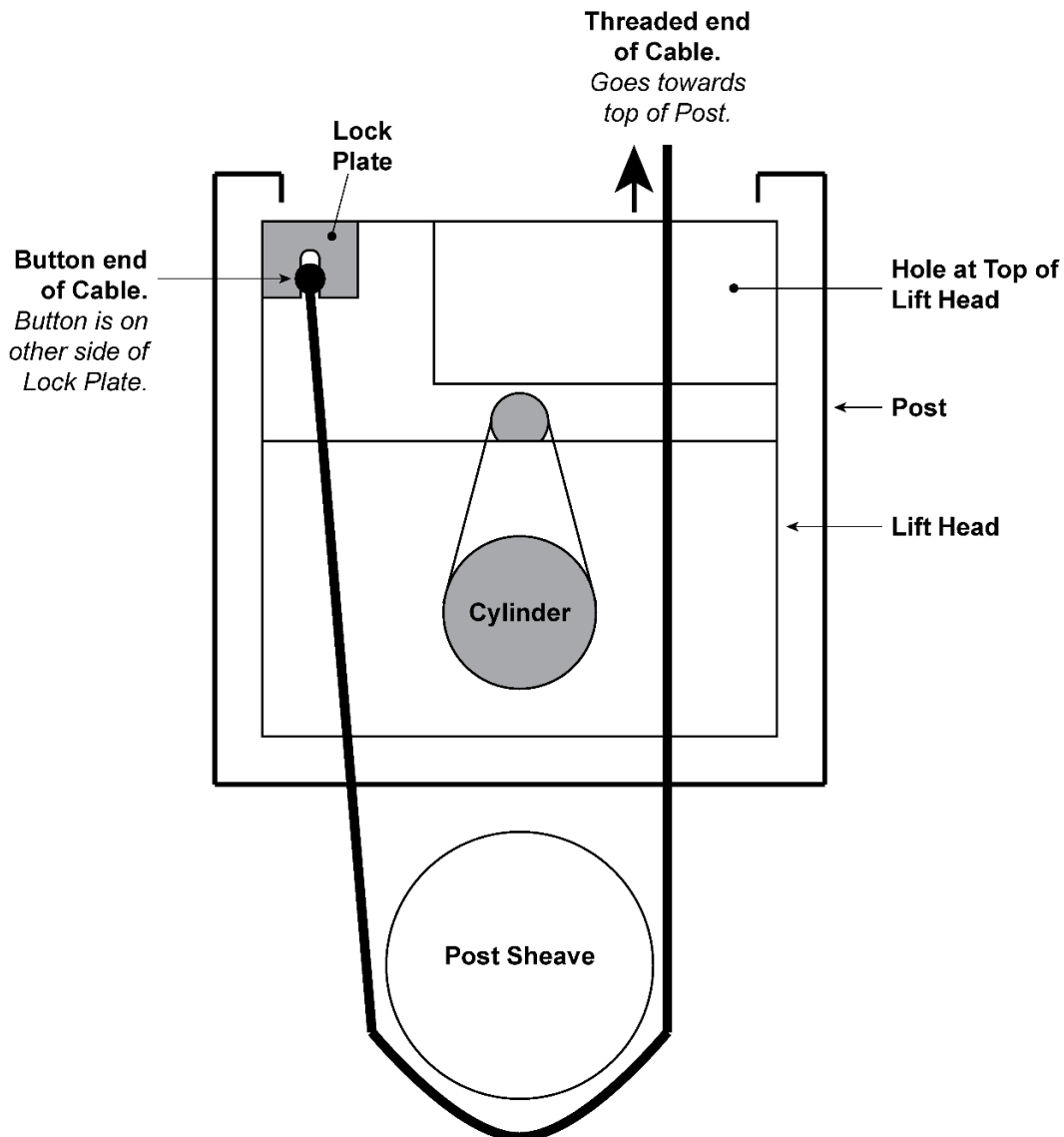

Drawing is not to scale. Not all components shown. View is from under bottom of Lift Head looking towards top of Lift Head. Both Posts look the same from this viewpoint.

4. Remove the Post Sheave from the bottom of the Post whose Lift Head you just moved up.

Keep the Post Sheave, the pin, and the bolt nearby; you will be re-installing them soon.

5. Find the two Equalizing Cables.

For Symmetric models, both Equalizing Cables are the same length, so it does not matter which one you install first.

For Asymmetric models, the Equalizing Cables are different lengths. You must route the longer Equalizing Cable over the Overhead Assembly Sheaves closer to the Approach side of the Lift.

Important: The lengths of each Equalizing Cable are shown on a tag attached to the cable. If the tags have fallen off, lay the cables out to determine which is longer. The difference may be only a few inches. However, if you mix them up, the Lift will not work correctly and you will have to remove them and then re-install them correctly.

6. Take an Equalizing Cable and locate the Button end you are going to use (for a Wide Configuration, use the Button end at the very end of the cable; for a Narrow Configuration, use the Button end away from the end of the cable).

If you are installing an Asymmetric model, route the longer Equalizing Cable over the Overhead Assembly Sheaves on the Approach side of the Lift (the Sheaves that are furthest apart) and the shorter Equalizing Cable over the Sheaves on the Front side of the Lift.

7. Push the Button end up through the bottom of the Lift Head up towards the Lock Plate.
8. Put the Button end of the Equalizing Cable into the Slot in the Lock Plate.

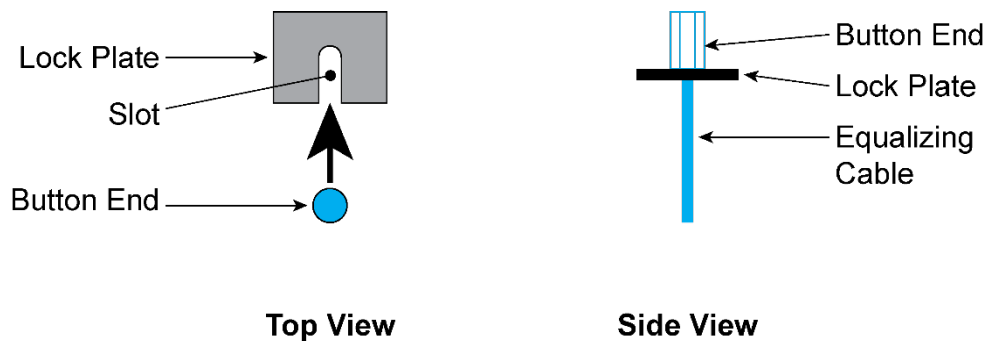

It can be difficult to get the Button end into the Slot, as it may be hard to reach the Lock Plate. You may want to use a metal rod or a long tool to push the Button end into the Slot.



Tip

If you are having problems getting the Button end into the Slot, you might want to try pushing the Button end past the Lock Plate and out the Hole at the Top of the Lift Plate; now, move the Equalizing Cable around to get the *cab*le into the Slot. Once the cable is in the Slot, pull on the other end of the cable to slide the Button end into the Slot. Try to keep the cable taut until the Equalizing Cable is connected at the other end, done later in the installation. It can be difficult to get the cable back into the Slot if it comes out.

Only the Button end goes above the Lock Plate; the rest of the cable goes under the Lock Plate.

9. If you are using the Narrow configuration, bend the top of the Equalizing Cable so that so that it is out of the way of the other components in the Post.
10. Route the Equalizing Cable down to where the Post Sheave used to be and then up again towards the top of the Post.
11. Re-install the Post Sheave, making sure the Equalizing Cable is routed under it and in the Sheave.
12. Push the Threaded end of the Equalizing Cable through the Lift Head and out the Hole at the Top of the Lift Head.
13. Coil up and bind the rest of the Equalizing Cable (the portion above the Hole at the Top of the Lift Head), then leave it resting on top of the Post until later in the installation.
14. Move both Lift Heads back down to the bottom of each Post.

Adding Extensions Pieces

XPR-10 Series models with **-168** or **-181** in their model names come with Post Extensions that raise the height of the Posts, letting you raise taller Vehicles.

The Post Extensions are slipped over the top of both Posts and then bolted into place.

There is no other change to either the rest of the installation or to operation of the Lift because you are using Extension Pieces.

To install Post Extensions:

1. Locate the two Post Extensions and the eight Bolts, eight Flat Washers, eight Split-Lock Washers, and eight Nuts.
2. Slide one of the Post Extensions over the top of one of the Posts.

See the drawing to the right.

The opening in the Post Extension goes on the inside.

3. Take a Bolt, put a Flat Washer on the Bolt, and then install the Bolt from the outside of the Post Extension into one of the four holes on the Post Extension.
4. Add a Split-Lock Washer to the Bolt on the inside of the Post Extension, add a Nut to the end of the Bolt, and then tighten the Nut.
5. Perform Steps 3 and 4 for the other three holes on the Post Extension.
6. Slide on the other Post Extension and secure it the same way.

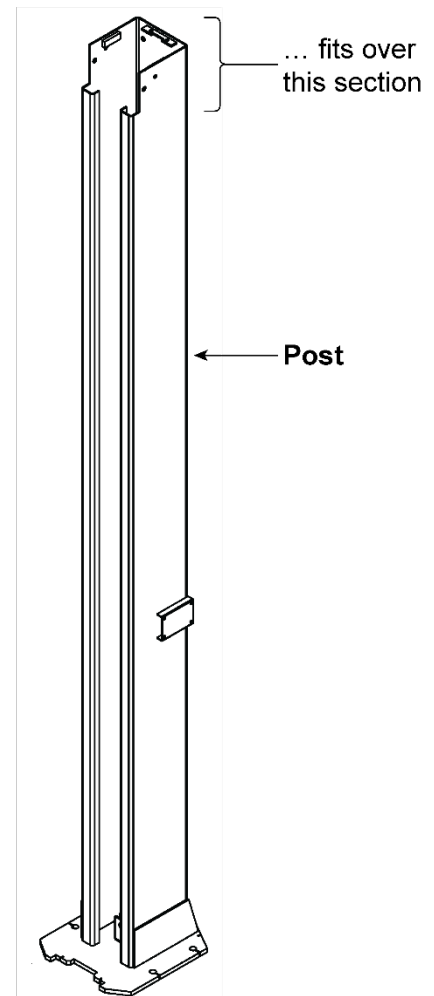
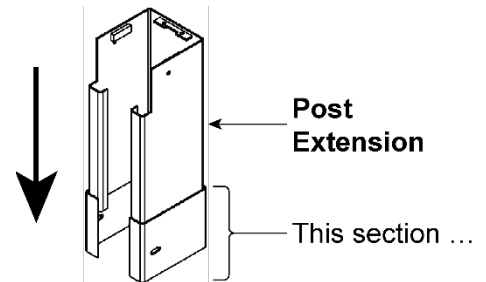

Routing Hydraulic Lines

It is easier to put some hydraulic components into position **before** you stand up the Posts.

Hydraulic Lines move Hydraulic Fluid to and from the Hydraulic Cylinders at the bottom of each Post. Hydraulic Fittings are used to make connections.

All XPR-10 Series Lifts use either three or four Hydraulic Lines:

- **One Short Hydraulic Line (A in drawing below).** Goes from the Power Unit up to the Tee Fitting on the Powerside Post; connects on the **outside** of the Post.
- **One Medium Hydraulic Line (B).** Goes from the Tee Hydraulic Fitting on the **inside** of the Powerside Post down to the bottom of the Powerside Hydraulic Cylinder. The straight end connects to the Tee Hydraulic Fitting and the curved end to the bottom of the Cylinder.
- **One Long Hydraulic Line (C).** Goes from the **inside** of the Powerside Post above the Tee Fitting, over the Overhead Assembly, and down the Offside Post to the bottom of the Offside Hydraulic Cylinder. The straight end connects to the Tee Hydraulic Fitting and the curved end to the bottom of the Cylinder.
- **One Very Short Hydraulic Line (D).** Goes on the inside of the Powerside Post, connecting to the Tee Hydraulic Fitting and the Long Hydraulic Line; **for Wide Configurations only.** Without this extension, the Long Hydraulic Line would not be long enough for Wide Configurations. This Line is ~13" for Symmetric Lifts, ~8" for Asymmetric Lifts. *Not used for Narrow Configurations.*

All Hydraulic Lines and Hydraulic Fitting locations are shown in the drawing below.

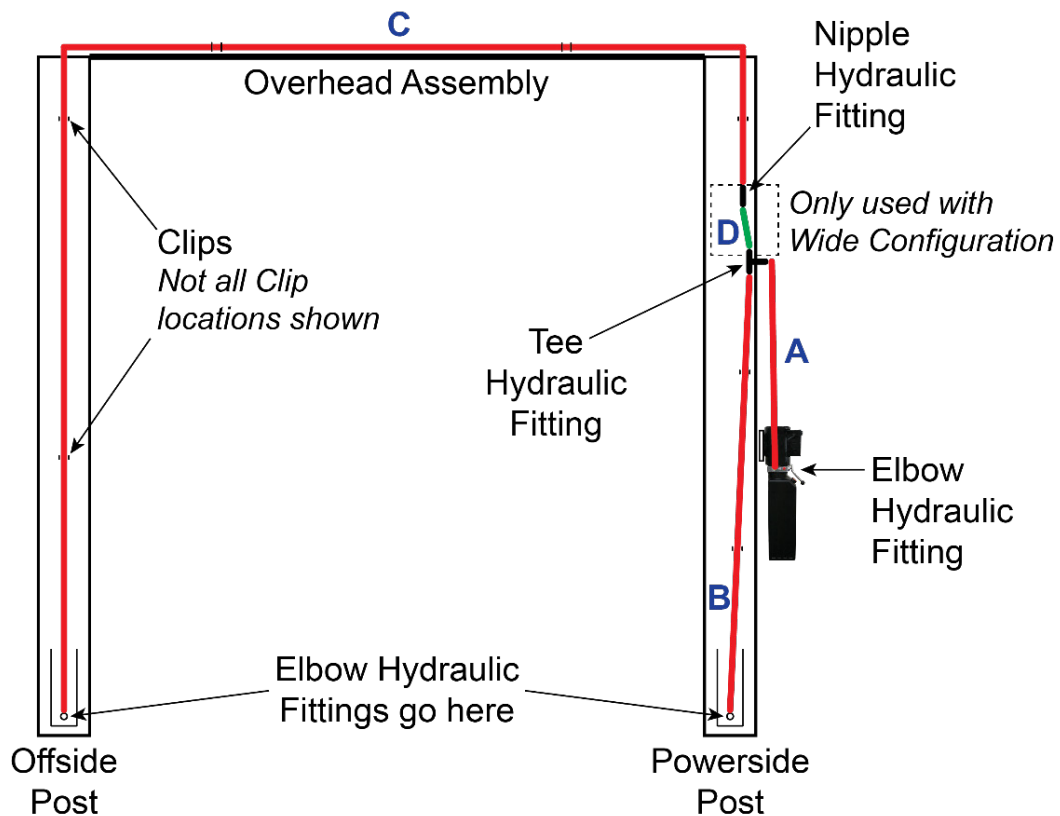

Drawing not necessarily to scale. Not all components shown. Some components exaggerated for clarity. Drawing shows Long Hydraulic Line (C) in place across the Overhead Assembly, but that cannot be done until later in the installation. The Elbow Hydraulic Fitting on the Power Unit is not the same as the Elbow Hydraulic Fittings on the bottom of each Hydraulic Cylinder.

The following procedure covers installing the Hydraulic Tee Fitting, the Medium and Long Hydraulic Lines, the Elbow Hydraulic Fittings that go at the bottom of the Hydraulic Cylinders, and the Very Short Hydraulic Line and Nipple Fitting used only with Wide Configurations. It does **not** cover the Short Hydraulic Line or the Elbow Fitting that connects to the Power Unit (they are covered later).

To put the Hydraulic Lines and Hydraulic Fittings into position:

1. Locate the necessary Hydraulic Lines: One Short, one Medium, one Long, and one Very Short (for Wide Configurations only).
2. Locate the necessary Hydraulic Fittings: Two interchangeable Elbows, one Tee (and a Nut that holds it in place), and one Nipple (for Wide Configurations only).

Note: The Elbow Hydraulic Fitting on the Power Unit and the Short Hydraulic Line cannot be installed at this point, as the Power Unit is not yet in place.

3. **Starting most of the way up the Powerside Post**, push the single fitting (06 JIC) on the Tee Hydraulic Fitting (04 JIC to 04 JIC to 06 JIC) through the hole above the Mounting Bracket for the Power Unit **from inside the Powerside Post**.

Note: There is only one Tee Hydraulic Fitting and it is installed on the Powerside Post *above* where the Power Unit will be installed.

The end result of installing the Tee Hydraulic Fitting is two connectors inside the Powerside Post, one connector protruding outside the Powerside Post, as shown in this drawing.

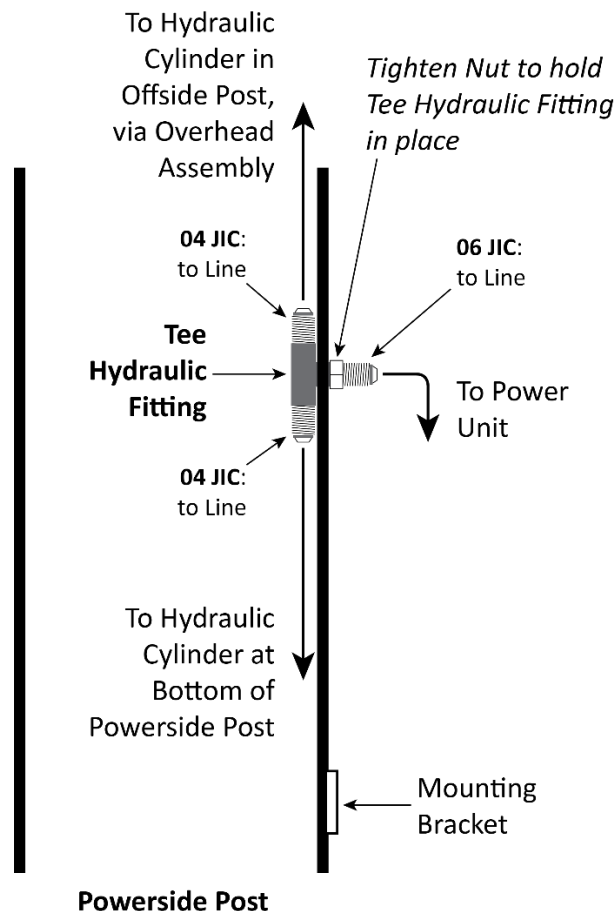

Drawing not to scale. Not all components shown. Some components exaggerated for clarity.

4. Tighten the Nut on the **outside** of the Powerside Post to hold the Tee Hydraulic Fitting in place.

5. **Switching to the bottom of the Powerside Post**, remove the Shipping Plug from the Hydraulic Line Connector on the **bottom** of the Hydraulic Cylinder (located at the bottom of the Powerside Post).

You can turn or move the Hydraulic Cylinder if necessary.

You might want to have a rag nearby in case some fluid leaks out of the Hydraulic Line Connector when you remove the Shipping Plug.

6. Connect one of the two interchangeable Elbow Hydraulic Fittings (NPT to JIC) to the Hydraulic Line Connector at the bottom of Hydraulic Cylinder on the Powerside Post.

Point the JIC connector towards the side of the Post with the Clips.

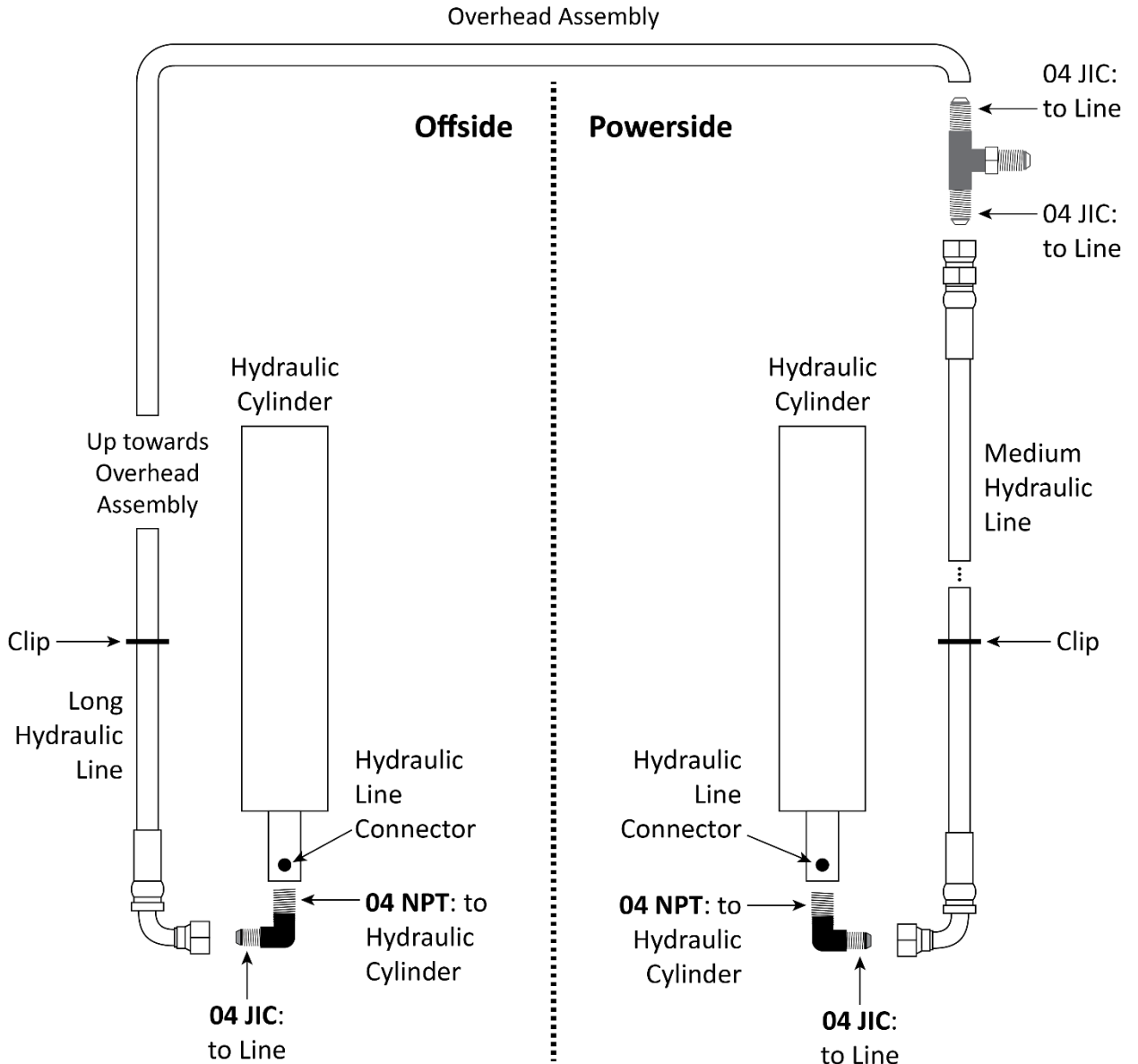

Not necessarily to scale. Not all components shown. Some components shown exaggerated.

-
8. Tighten the Elbow Hydraulic Fitting appropriately; make sure to leave the unconnected end of the fitting pointing towards the side of the Powerside Post that has the Clips for the Medium Hydraulic Line (the same fitting on the Offside Post also needs to point towards the side with the Clips).
 9. Turn the Hydraulic Cylinder so that the Elbow Hydraulic Fitting is accessible from the bottom back side of the Powerside Post.

Important: When routing Hydraulic Lines, after they are positioned correctly, put them into the nearby Clips and lightly crimp the Clips together. When all Hydraulic Lines have been installed, go back and fully crimp all of the Clips. You need to make sure the Clips are crimped tightly enough to hold the Hydraulic Lines in place but not so tightly that the flow of Hydraulic Fluid in the Hydraulic Lines is impacted. *There are Clips only along one side of each Post.*

10. Take the Medium Hydraulic Line, connect the Straight End to the bottom of the Tee Hydraulic Fitting, and tighten securely.
11. Push the Curved End of the Medium Hydraulic Line down to the bottom of the Powerside Post and connect it to the JIC connector on the Elbow Hydraulic Fitting; tighten securely.
12. **Switching to the Offside Post**, connect the other Elbow Hydraulic Fitting (NPT to JIC) to the Hydraulic Line Connector at the bottom of the Hydraulic Cylinder.
13. Tighten the Elbow Hydraulic Fitting securely; make sure to leave the unconnected end of the fitting pointing towards the side with the Clips.
14. Take the Long Hydraulic Line, push the Curved End down through the Post until it is at the bottom of the Post, then connect the Curved End to the Elbow Hydraulic Fitting you just connected and tighten securely.

Be sure to clip the Long Hydraulic Line to the Clips in the Post.
15. Carefully coil up and bind the rest of the Long Hydraulic Line, then leave it resting on top of the Offside Post until later in the installation.

Important: You should now have the Long Hydraulic Line connected to the bottom of the Hydraulic Cylinder in the Offside Post, with the rest of the Long Hydraulic Line coiled up at the top of the Offside Post. It will be connected to the rest of the Hydraulic System later in the installation.

Putting in Chalk Line Guides

Based on the Specifications for your Lift, create Chalk Line Guides on the ground for the two Posts prior to moving them into position.

Use the Width Overall value in **Specifications for your Lift model** to determine where to place the Chalk Line Guides. The Width Overall value is defined as the distance from the back of one base plate to the back of the other base plate.

Make sure to choose the Width Overall value for the Narrow or Wide orientation, based on the selection you made earlier.

The following drawing shows how to create Chalk Line Guides for an **Asymmetric** Lift.

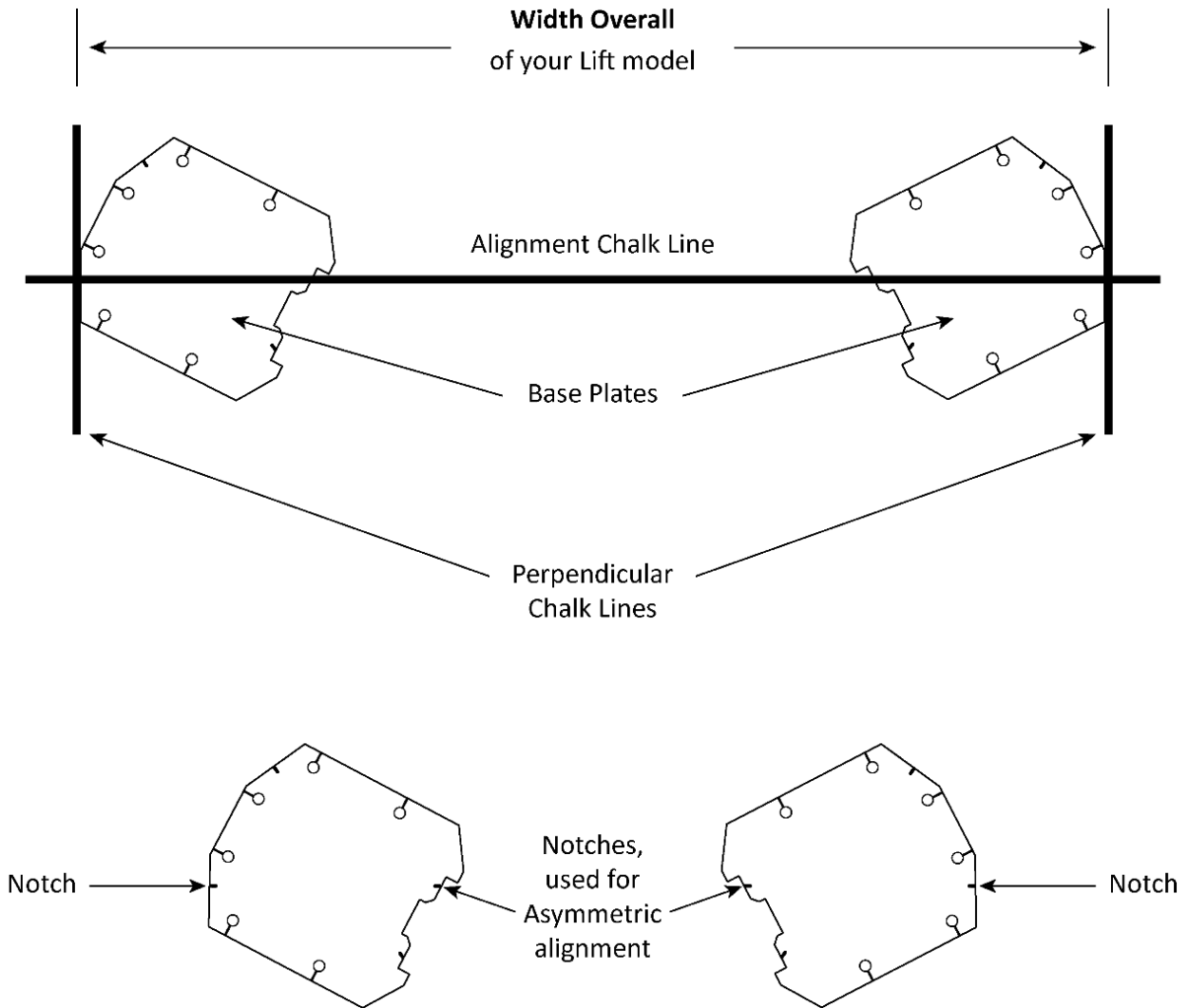

Not necessarily to scale. Not all components shown.

Make sure to choose the Width Overall value for the Narrow or Wide orientation, based on the selection you made earlier.

The following drawing shows how to create Chalk Line Guides for a **Symmetric** Lift.

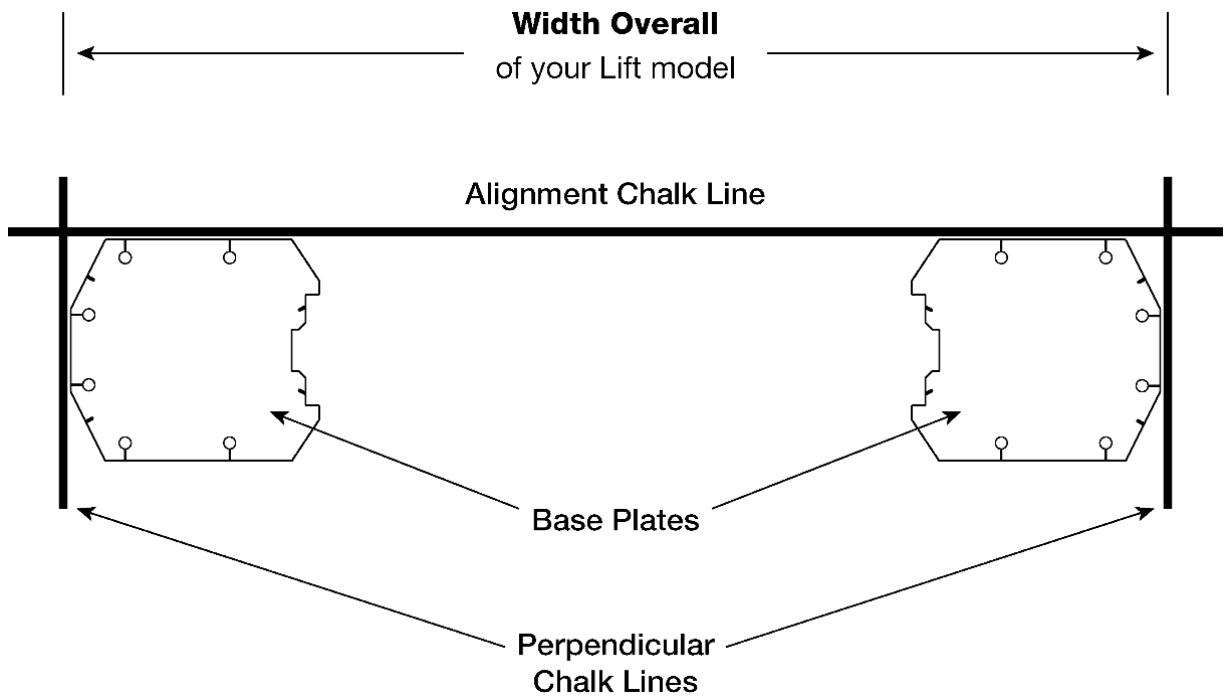

Not necessarily to scale. Not all components shown.

To add Chalk Line Guides:

1. Decide where you want to locate the Lift.
2. Create an Alignment Chalk Line at the Front of the Lift. For Symmetric Lifts, see the drawing above.

For Asymmetric Lifts, put the Alignment Chalk Line through the notches; see the drawing on the previous page.

Make the Alignment Chalk Line longer than the Width Overall setting for your Lift model.

Make sure to use the Width Overall setting for Narrow or Wide orientation.

3. Create two Perpendicular Chalk Lines at 90° angles to the Alignment Chalk Lines at the Width Overall distance for the Lift model you are installing.

The two Perpendicular Chalk Lines must be **X** distance from each other, where **X** is the Width Overall setting (Narrow or Wide, depending on your selection) for your Lift model.

4. When you move the Posts into position for a **Symmetric** Lift, put the Base Plates into the corners created by the Chalk Line Guides, as shown in the drawing on this page.
5. When you move the Posts into position for an **Asymmetric** Lift, align the correct notches in each of the Bases Plates with the Alignment Chalk Line, as shown in the drawing on the previous page.

Installing the Posts

We strongly recommend having multiple people work together to install the Posts.

 **DANGER** Pay *special* attention when installing the Posts. If done incorrectly, the Lift could fall over, potentially causing damage to the Vehicle, the Lift, and injuring bystanders.

Concrete specifications are:

- **Depth:** 4.25 inches (108 mm) thick
- **PSI:** 3,000 PSI, minimum
- **Cured:** 28 days, minimum

The Concrete floor where you want to install your Lift must meet the following requirements:

- The floor must be a flat, Concrete floor. It must be level; **do not install the Lift on a surface with more than three degrees of slope.**
- Do not install the Lift on cracked or defective Concrete.
- Check the floor for the possibility of it being a post-tension slab. In this case, contact the building architect before drilling. Using ground penetrating radar may help you find the tensioned cable.

 **WARNING** Cutting through a tensioned cable can result in injury or death. Do not drill into a post-tension slab unless the building architect confirms you are *not* going to hit a tensioned cable or you have located it using ground penetrating radar. **If colored sheath comes up during drilling, stop drilling immediately.**

Anchor Bolt specifications are:

- **Length:** 6.3 inches (160 mm)
- **Diameter:** .75 inch (19 mm)
- **Anchor torque:** 110 – 150 foot pounds

 **WARNING** Your Concrete and Anchor Bolts *must* meet these specifications. Only install your Lift on a Concrete surface. If you install a Lift on asphalt or any other surface, or your Concrete or Anchor Bolts do not meet these specifications, it could lead to product damage, Vehicle damage, personal injury, or even loss of life.

BendPak Lifts are supplied with installation instructions and concrete fasteners meeting the criteria as prescribed by the American National Standard “Automotive Lifts – Safety Requirements for Construction, Testing, and Validation” ANSI/ALI ALCTV-2006.

 **WARNING** Use only the ALI-certified Anchor Bolts that came with your XPR-10 Series Lift. If you use components from a different source, you void your warranty and compromise the safety of everyone who installs or uses the Lift.

Lift buyers are responsible for conforming to all regional, structural, and seismic anchoring requirements specified by any other agencies and/or codes, such as the Uniform Building Code and/or International Building Code.



Tip Consider *not* torquing the Anchor Bolts into position yet. Installing the Overhead Assembly and doing final leveling may be easier if there is some play in the Posts.

To install the Posts:

1. Using a Forklift or Shop Crane, move the Posts to the Chalk Line Guides you created earlier.
2. Stand up each Post, one at a time, and move it to the appropriate location relative to the Chalk Line Guides.
3. Double check your measurements against the **Specifications** for your Lift model:
 - Distance from back of one Base Plate to back of the other Base Plate: **Width Overall** value
 - Distance from inside of one Post to inside of the other Post: **Inside Posts** value
4. Using the Base Plates as guides, drill each hole 5 inches deep.

Do not drill all the way through the Concrete; if you punch completely through the slab, you could compromise the holding strength of the Anchor Bolt once put into place.

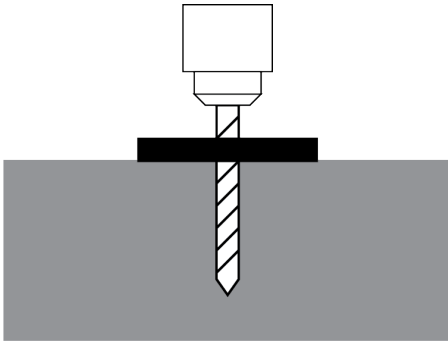

Go in straight; do not let the drill wobble.

Use a carbide bit (conforming to ANSI B212.15-1994).

The diameter of the drill bit must be the same as the diameter of the Anchor Bolt. So if you are using a $\frac{3}{4}$ inch diameter Anchor Bolt, for example, use a $\frac{3}{4}$ inch diameter drill bit.

5. Vacuum each hole clean.

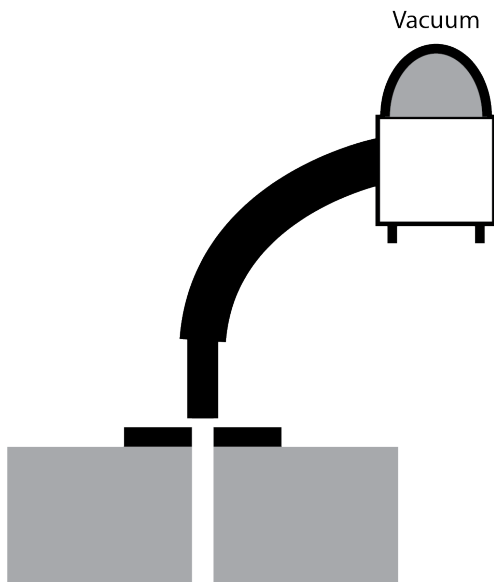

BendPak recommends using a vacuum to get the hole very clean. You can also use a wire brush, hand pump, or compressed air; just **make sure to thoroughly clean each hole**.

Do **not** ream the hole. Do **not** make the hole any wider than the drill bit made it.

Important: The holding strength of an Anchor Bolt is partially based on the how cleanly the Expansion Sleeve presses against the Concrete. If the hole is dirty, the Expansion Sleeve does not press as cleanly, which means less holding strength. If the hole is too wide, the Expansion Sleeve does not press against the Concrete with as much force, again resulting in less holding strength.

6. Make sure the Washer and Nut are in place, then insert the Anchor Bolt into the hole.

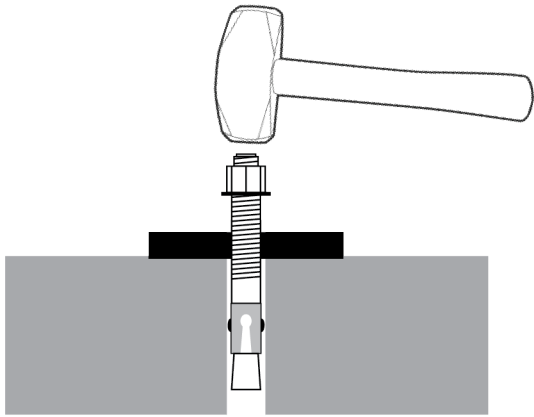

The Expansion Sleeve of the Anchor Bolt may prevent the Anchor Bolt from passing through the hole in the Base Plate; this is normal. Use a hammer or mallet to get the Expansion Sleeve through the Base Plate and into the hole.

Even using a hammer or mallet, the Anchor Bolt should only go into the hole part of the way; this is normal. If the Anchor Bolt goes all the way in with little or no resistance, the hole is too wide.

Once past the hole in the Base Plate, the Anchor Bolt eventually stops going down into the hole as the Expansion Sleeve contacts the sides of the hole; this is normal.

7. Hammer or mallet the Anchor Bolt the rest of the way down into the hole.

Stop when the Washer is snug against the Base Plate.

9. Plumb each Post; install any needed Shims or the optional Adapter Trays (which let you stack the provided Auxiliary Adapters — also called Extenders — conveniently near the Lift Arms).

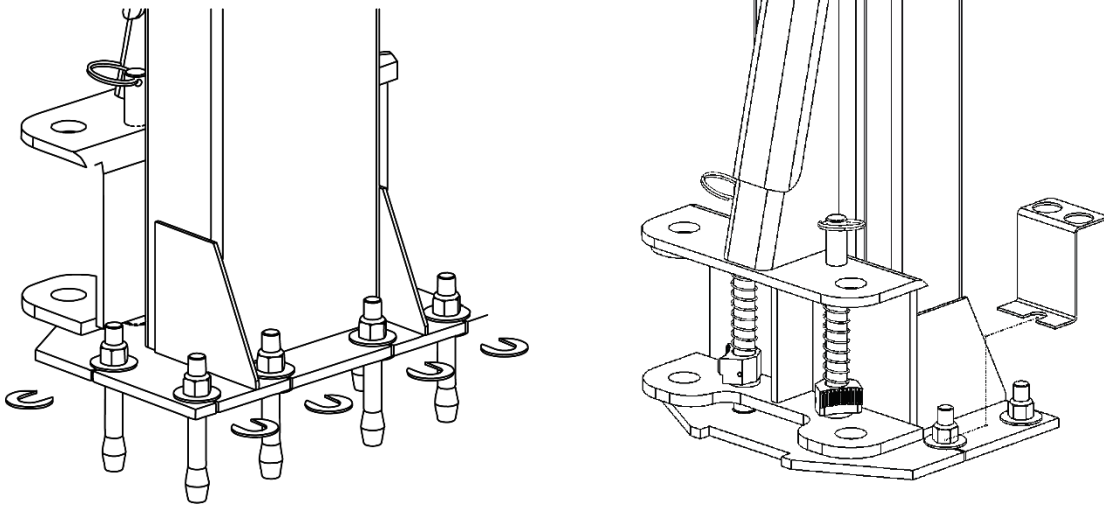

Tip If you are going to torque the Anchor Bolts later so that installing the Overhead Assembly and doing final leveling is a little easier, skip the next step. Instead, make sure the Anchor Bolts are securely in position; you do not want the Posts moving too much during the rest of the installation procedure.

10. Wrench each Nut **clockwise** to the recommended installation torque, 110 – 150 foot pounds, using a Torque Wrench.

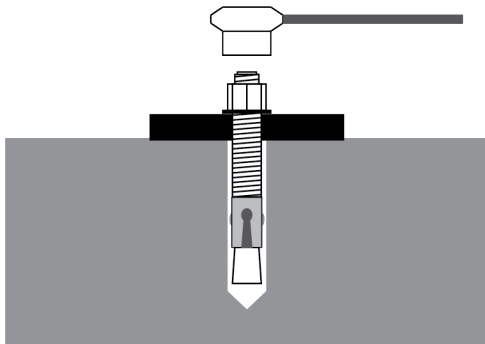

Important: Do **not** use an impact wrench to torque the Anchor Bolts.

Wrenching the Nut forces the Wedge up, forcing out the Expansion Sleeve and pressing it tightly against the Concrete.

Installing the Overhead Assembly, Safety Shutoff Bar, and the Microswitch

The Overhead Assembly goes above and between the Powerside and Offside Posts. It holds the Equalizing Cables, the Hydraulic Lines, the Microswitch wiring, and the Safety Lock Cable.

The Safety Shutoff Bar and the Microswitch (or two Microswitches if you ordered a three-phase Power Unit) are installed on the underside of the Overhead Assembly.

The Safety Shutoff Bar shuts off power to the Lift if the top of a Vehicle hits it; this trips the Microswitch, which cuts off power to the Lift, preventing it from going any higher.

The Microswitch **wiring** goes over the Overhead Assembly and down the Powerside Post to the Power Unit. Wiring the Microswitch is not covered in this section; it is covered in **Wiring the Microswitch**. Have your Electrician connect the Microswitch wiring to the Power Unit when they come out to perform the other electrical tasks.

The Overhead Assembly is two pieces that are bolted together. The Overhead Assembly and the Safety Shutoff Bar come from the factory already assembled in the Narrow Configuration. On rare occasions, the two pieces could come from the factory unassembled.

This leaves you with these options:

- **You want the Wide Configuration.** If the Overhead Assembly and the Safety Shutoff Bar came from the factory assembled in the Narrow Configuration, and you earlier decided on the Wide Configuration, you need to change the Overhead Assembly and the Safety Shutoff Bar to the Narrow Configuration, install the Microswitch, and then put the Overhead Assembly into place.

Note: The Narrow or Wide Configuration decision should already have been made (in **Choosing a Wide or Narrow Configuration**). Refer to that section for additional information.

- **You want the Narrow Configuration.** If the Overhead Assembly and the Safety Shutoff Bar came from the factory assembled in the Narrow Configuration, which is what you want, install the Microswitch and then put the Overhead Assembly into place.
- **The Overhead Assembly comes unassembled.** If the Overhead Assembly and the Safety Shutoff Bar came from the factory unassembled, install the Overhead Assembly in the desired configuration (using the drawings in this section as guides), install the Safety Shutoff Bar, install the Microswitch, and then put the Overhead Assembly into place.

BendPak recommends putting the Overhead Assembly on saw horses to prepare it.

To prepare and install the Overhead Assembly:

1. If the Overhead Assembly came unassembled, locate the two Overhead Assembly pieces and the four M10 x 1.5 x 25 Hex Head Bolts, four M10 x Ø20 Flat Washers, four M10 x Ø18 Split Lock Washers, and four M10 x 1.5 Nuts needed to connect them.

If your Overhead Assembly came assembled from the factory, even if in the wrong configuration for your installation, these pieces are already in place.
2. Put the Overhead Assembly together in the desired configuration.
3. Remove all four Overhead Assembly Sheaves and their Pins and Bolts from the ends of the Overhead Assembly pieces.

Keep them nearby, you will be putting them back into place in the next section of the installation.

The following drawings shows the Bolt/Washer/Nut locations for both Narrow and Wide Configurations for Symmetric and Asymmetric models.

Symmetric

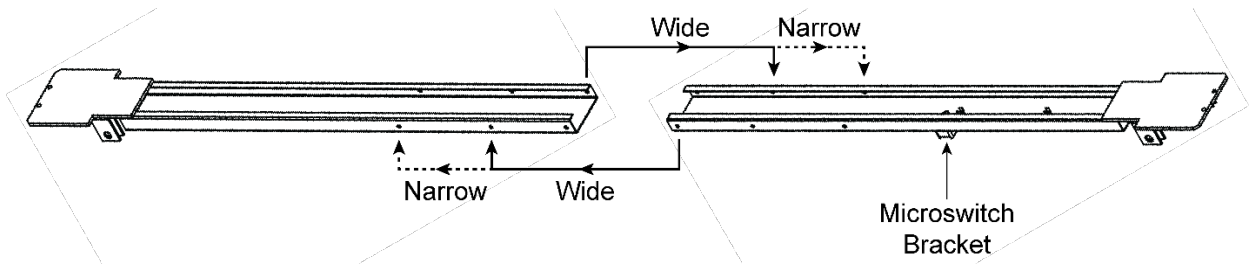

Asymmetric

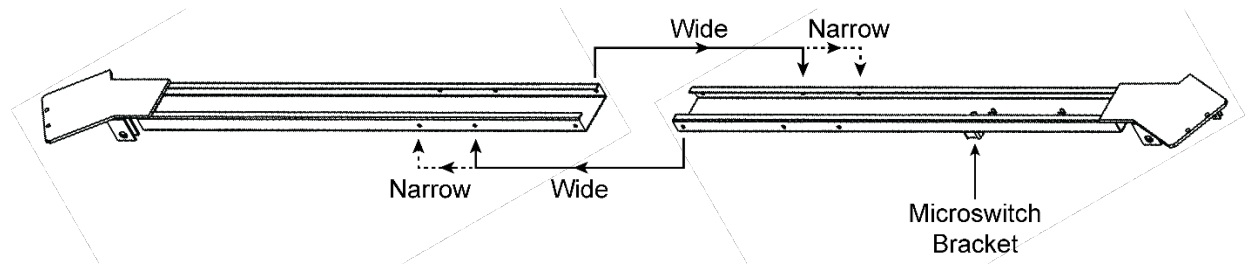

Note: When you line up the two Overhead Assembly pieces together, there will be four holes that go through both pieces. Two holes on each side of the Overhead Assembly.

- Put the Safety Shutoff Bar in place in the desired configuration.

If you are switching the Safety Shutoff Bar from Narrow to Wide Configuration, loosen the Slider Stops, adjust the Safety Shutoff Bar appropriately, then re-tighten the Slider Stops.

The following drawing shows the components on the Safety Shutoff Bar.

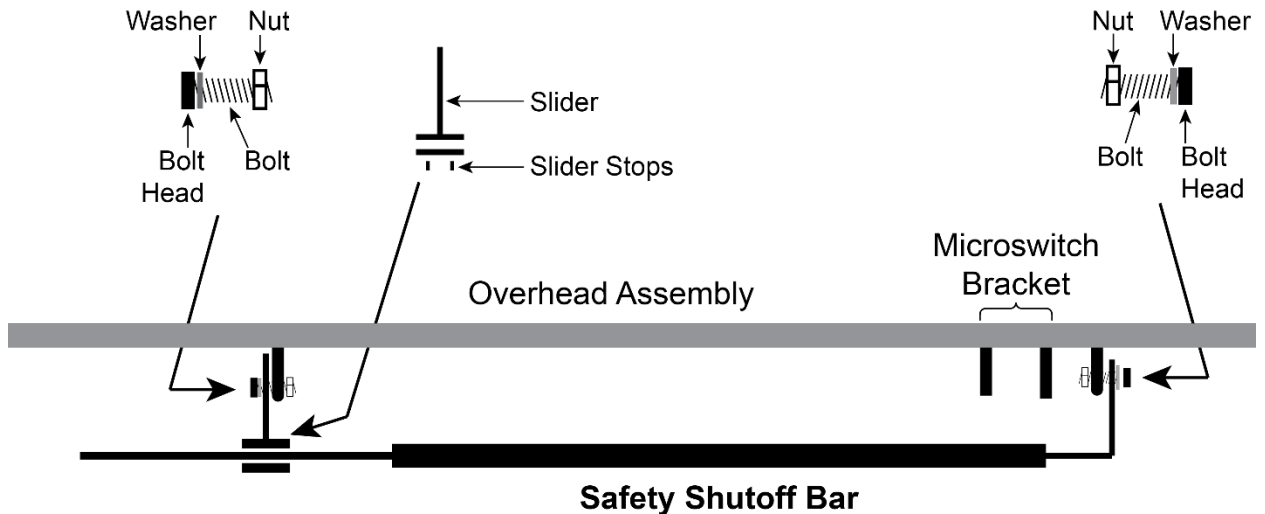

The following procedure describes how to install a Microswitch on the Overhead Assembly, but does not describe how to wire it, which is covered in [Wiring the Microswitch](#).

If you have **two** Microswitches because you are using a three-phase Power Unit, simply install the two of them next to each other in the Microswitch Bracket.

To install the Microswitch:

1. Locate the Microswitch, the Microswitch Cover, the Bolts, and the Nuts required to install the Microswitch.

Each Microswitch comes with an individual cover that covers the connection points and wiring at the top of the Microswitch. The Microswitch Cover covers the Microswitch from the bottom; it bolts onto the Microswitch Bracket.

2. Put the Microswitch into position in the Microswitch Bracket such that the Safety Shutoff Bar, when moved upwards, will push up the Trigger.

The following drawing is a side view showing the Safety Shutoff Bar getting pushed up and triggering the Microswitch.

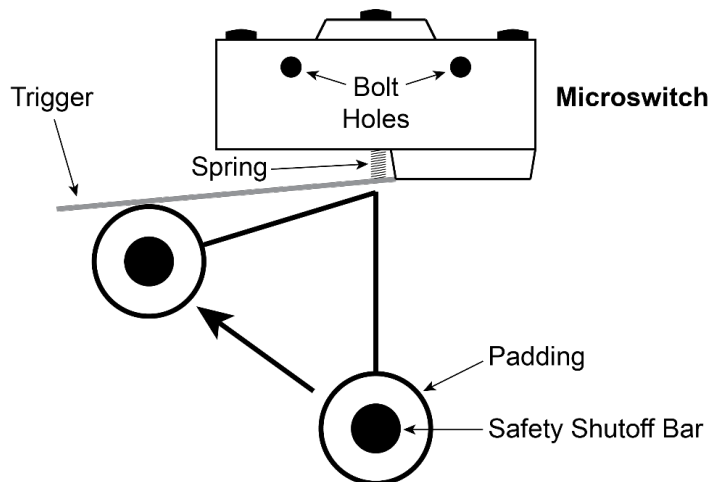

When the Trigger is pushed up, it completes the circuit and cuts power to the Power Unit, stopping the Lift from rising any further and thus preventing the top of your Vehicle from hitting the Overhead Assembly.

3. If you are installing a second Microswitch, put it into position next to the one you just installed.
4. Use the Bolts and Nuts to secure the Microswitch in place.
5. Bolt the Microswitch Cover into place.
6. Use an appropriate lifting device to put the Overhead Assembly into position.
Make sure the Microswitch Bracket is on the Powerside.
7. Bolt the Overhead Assembly to the top of the Posts using two Bolts and Nuts on each end.

Installing the Equalizing Cables

The two Equalizing Cables keep the Lift Heads synchronized as they raise and lower.

Both Equalizing Cables should have been put into position on the Posts before the Posts were raised, which was covered in **Putting Equalizing Cables into Position**.

This section picks up where that section left off: the Button Ends of the Equalizing Cables (on both Posts) have been installed, routed around the Post Sheaves, and then pushed up above the Lift Head. They now need to be routed over the Overhead Assembly and then down to the top of the Lift Head.

Important: If your Equalizing Cables are not yet in position, you must go back and put them into position before performing the following procedure.

When Equalizing Cables are fully routed, they are mirror images of each other.

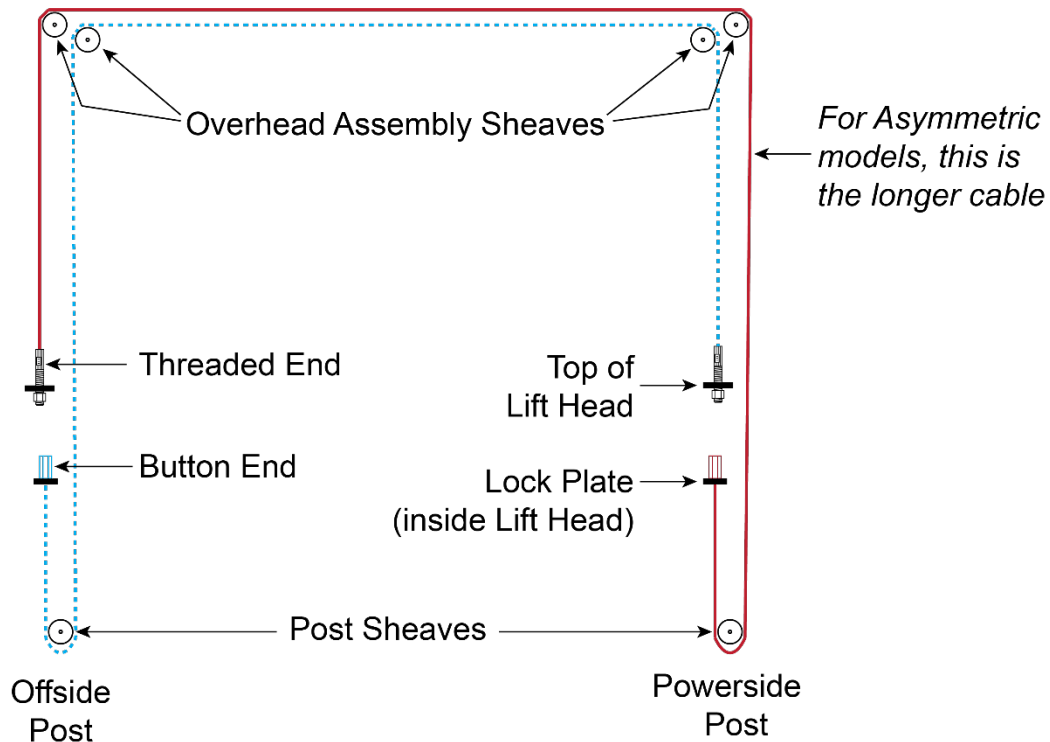

Not necessarily to scale. Not all components shown. Some components exaggerated for clarity. Asymmetric model shown, so one cable is longer than the other.

To route the Equalizing Cables:

1. Manually raise both Lift Heads about 28 inches / 711 mm off the ground and engage them on the closest Safety Lock.

Make sure both Lift Heads are the same distance off the ground.

2. Make sure the Button Ends of both Equalizing Cables are still in the Slots in their Lock Plates, that both Equalizing Cables go under the Post Sheave in their Posts, and that the Threaded Ends have been routed through the Hole at the Top of the Lift Head.

If either cable is not correct, fix it; you cannot continue until the Equalizing Cables are in their correct starting positions.

Remember, for a Wide Configuration, use the Button End at the very end of the Equalizing Cable. For a Narrow Configuration, use the Button End away from the end of the Equalizing Cable.

3. Choose which one of the two Equalizing Cables you are going to put into position first, then remove the Nut from the Threaded End of that cable.

The Overhead Assembly Sheave, Sheave Pin, and Sheave Pin Bolt were previously removed. If they were mistakenly re-installed, you need to remove them again.

4. Route the Threaded End of the Equalizing Cable up on the inside of the Post, under the Sheave Bracket, and then out over the top of the Overhead Assembly.

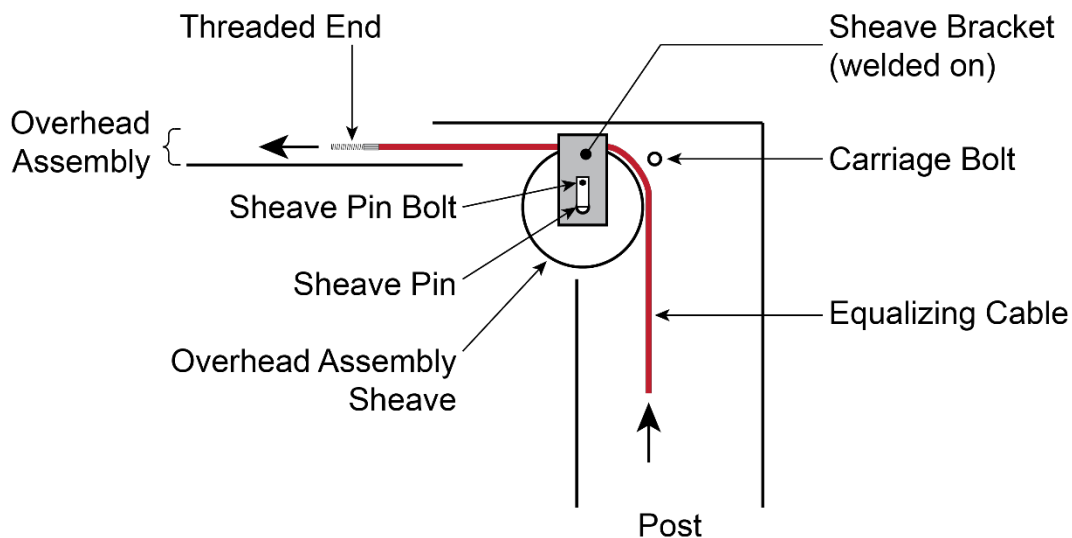

5. Re-install the Overhead Assembly Sheave, Sheave Pin, and Sheave Pin Bolt.
6. At the other Post, remove the Nut from the Threaded End of the other Equalizing Cable.
The Overhead Assembly Sheave, Sheave Pin, and Sheave Pin Bolt were previously removed. If they were mistakenly re-installed, you need to remove them again.
7. Route the Threaded End under the Sheave Bracket, then down the Post towards the Lift Head.
8. Re-install both the Overhead Assembly Sheave, Sheave Pin, and Sheave Pin Bolt.
9. Put the Threaded End of the Equalizing Cable through the hole at the top of the Lift Head, then install the Nut and securely tighten.

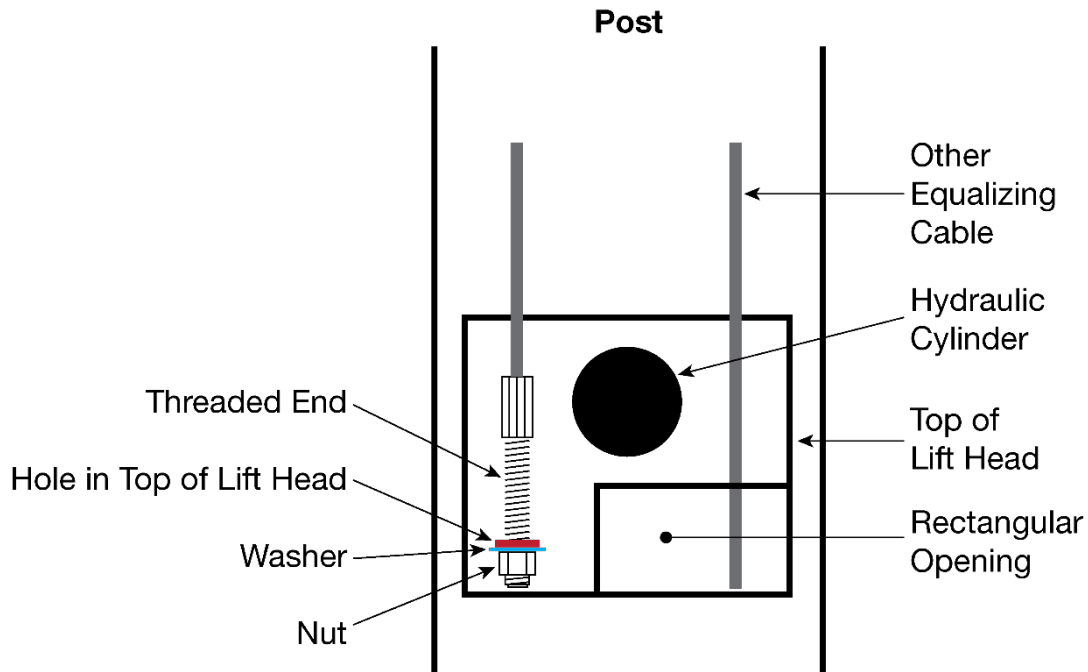

Drawing not necessarily to scale. Not all components shown. View is from inside Lift looking at the inside of the Lift. Both Posts look the same from this viewpoint.

10. Perform Steps 3 through 9 for the other Equalizing Cable.

Routing the Safety Lock Cable

The Safety Lock Cable and the Safety Lock Release Handle are used to release the Safety Locks, allowing the Lift to be lowered.

The Safety Lock Cable connects to the Safety Assembly on the Offside Post, goes over the Overhead Assembly, then to the Safety Assembly on the Powerside Post.

The following drawing shows the path the Safety Lock Cable travels from Safety Assembly on the Offside Post to the Safety Assembly on the Powerside Post.

The following procedure describes how to put the Safety Lock Cable into place; it does **not** describe how to attach it to the Safety Lock Releases.

⚠ WARNING You will need to access the Overhead Assembly to route the Safety Lock Cable. Use care to avoid falling when working on a ladder or other lifting device.

One end of the Safety Lock Cable has a loop on it, the other does not. The loop end must be installed on the Offside Post side, the other end on the Powerside Post side.

To route the Safety Lock Cable:

1. Locate the Safety Lock Cable.

The Safety Lock Cable is a long, thin steel cable with a loop on one end, no loop on the other end. The two ends are **not** interchangeable.

Make sure to orient the Safety Lock Cable so that the loop end goes to the Offside Post side of the Lift.

2. **Starting on the inside of the Offside Post**, push the loop end of the Safety Lock Cable out through a hole in the Offside Post.

The Offside Safety Assembly is not yet installed, so just leave the loop end of the Safety Lock Cable hanging out of the hole.

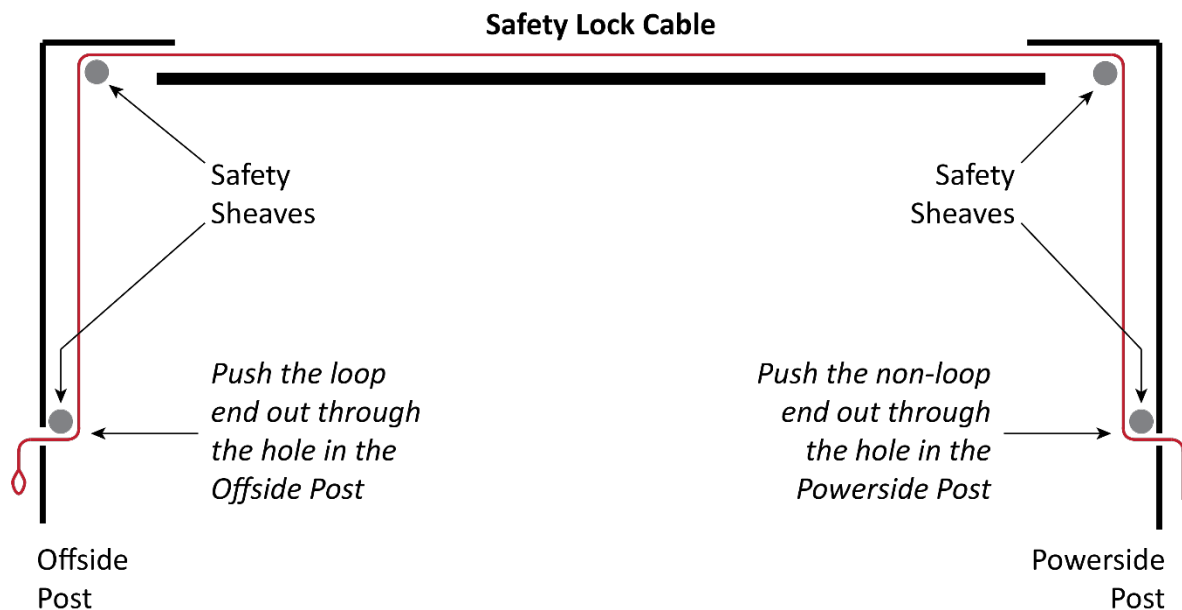

Not necessarily to scale. Not all components shown. The Safety Assemblies are not installed at this point, so the Safety Cable, after being routed, will simply stay in place until later in the installation.

3. Route the other end (the non-loop end) of the Safety Lock Cable under the Safety Sheave, upwards on the inside of the Offside Post, up and over the Safety Sheave at the top of the Offside Post, across the Overhead Assembly, over the Safety Sheave at the top of the Powerside Post, and then downwards, on the inside of the Powerside Post, towards the Mounting Bracket.

Make sure the Safety Lock Cable stays in its Safety Sheaves; this keeps it out of the way of the Equalizing Cables and the Hydraulic Lines.

4. **On the Powerside Post**, when the non-loop end of the Safety Lock Cable is near the Mounting Bracket, route it under the Safety Sheave, then push it out of the Powerside Post through a hole in the Post.

The Powerside Safety Assembly is not yet installed, so just leave the non-loop end of the Safety Lock Cable hanging out of the hole.

Important: When connecting the ends of the Safety Lock Cable later in the installation, make sure the Cable stays in all of the Safety Sheaves. This keeps it out of the way of the Hydraulic Lines and Equalizing Cables.

Both ends of the Safety Lock Cable will be appropriately connected during the procedure to install the Safety Assemblies. See [Installing the Safety Assemblies](#) for additional information.

5. **For both Posts**, locate the two Carriage Bolts (M10 rods, ~11 in / 275 mm long, threaded on both ends), two Nuts, and two Washers in the Parts Box, put them into place through the top of each Post (they go all the way through the top of the Post), and tighten them in place on both ends.

Mounting the Power Unit

This section describes how to mount the Power Unit for your Lift. You do **not** need an Electrician to **mount** the Power Unit, but you do need an Electrician to **connect** the Power Unit.

Important: Do not connect the Power Unit to the Hydraulic System or to the power source at this point in the installation; those connections will be made later.

Your Lift came with the Power Unit that was ordered. In order to support a wide variety of applications, that Power Unit could be one of multiple Power Units that are available. Because of this, the Power Unit that came with your Lift may look slightly different from the drawings in this Manual.

Refer to **Connecting the Power Unit** for installation information for your Electrician and specific information about the Power Unit that came with your Lift.

The Power Unit **must** be mounted on the Mounting Bracket on the Powerside Post.

To mount the Power Unit:

1. Find the supplied four Hex Bolts, four Nuts, and one Vibration Dampener.



Tip The Power Unit is heavy. BendPak recommends having one person hold the Power Unit while a second person bolts it into place.

2. Put the Vibration Dampener into place next to the Mounting Bracket on the Powerside Post.

Both the Vibration Dampener and the Mounting Bracket have four holes, one in each corner. Make sure to use all four holes to hold the Power Unit.

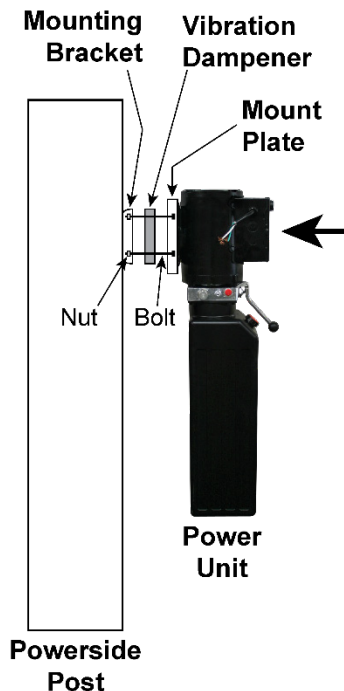

3. Move the Mount Plate on the back of the Power Unit next to the Vibration Dampener.
There are multiple holes on the Mount Plate you can use. You must use four holes to secure the Power Unit.
4. Push one of the Bolts through a hole in the Mount Plate, through the Vibration Dampener, and into the Mounting Bracket; attach a Nut to the thread end of the Bolt, then tighten the Nut.
5. Repeat Step 4 for the other three Bolts and Nuts.
6. Fill the reservoir with approved fluids.

The reservoir holds approximately 3.6 gallons (14 liters). Use care to keep the fluid clean when filling the reservoir.

Important: Do not connect the Power Unit to the Hydraulic System or the power source at this point.

Installing the Safety Assemblies and the Safety Lock Cable

Your XPR-10 Lift has two Safety Assemblies: one on the Powerside Post (above the Power Unit) and the other on the Offside Post.

The two Safety Assemblies take the Lift off of its Safety Locks so the Lift Arms can be lowered. The Safety Assemblies need to be disengaged at the same time so that the Lift Arms lower together. In order to do this, the two Safety Assemblies are connected to each other via the Safety Lock Cable, which is routed through the Overhead Assembly.

Routing the Safety Lock Cable was done earlier; refer to [Routing the Safety Lock Cable](#) for additional information.

The Safety Assembly on the Powerside Post includes a handle, which is used to lower the Lift off of its Safety Locks (in conjunction with the Lowering Handle).

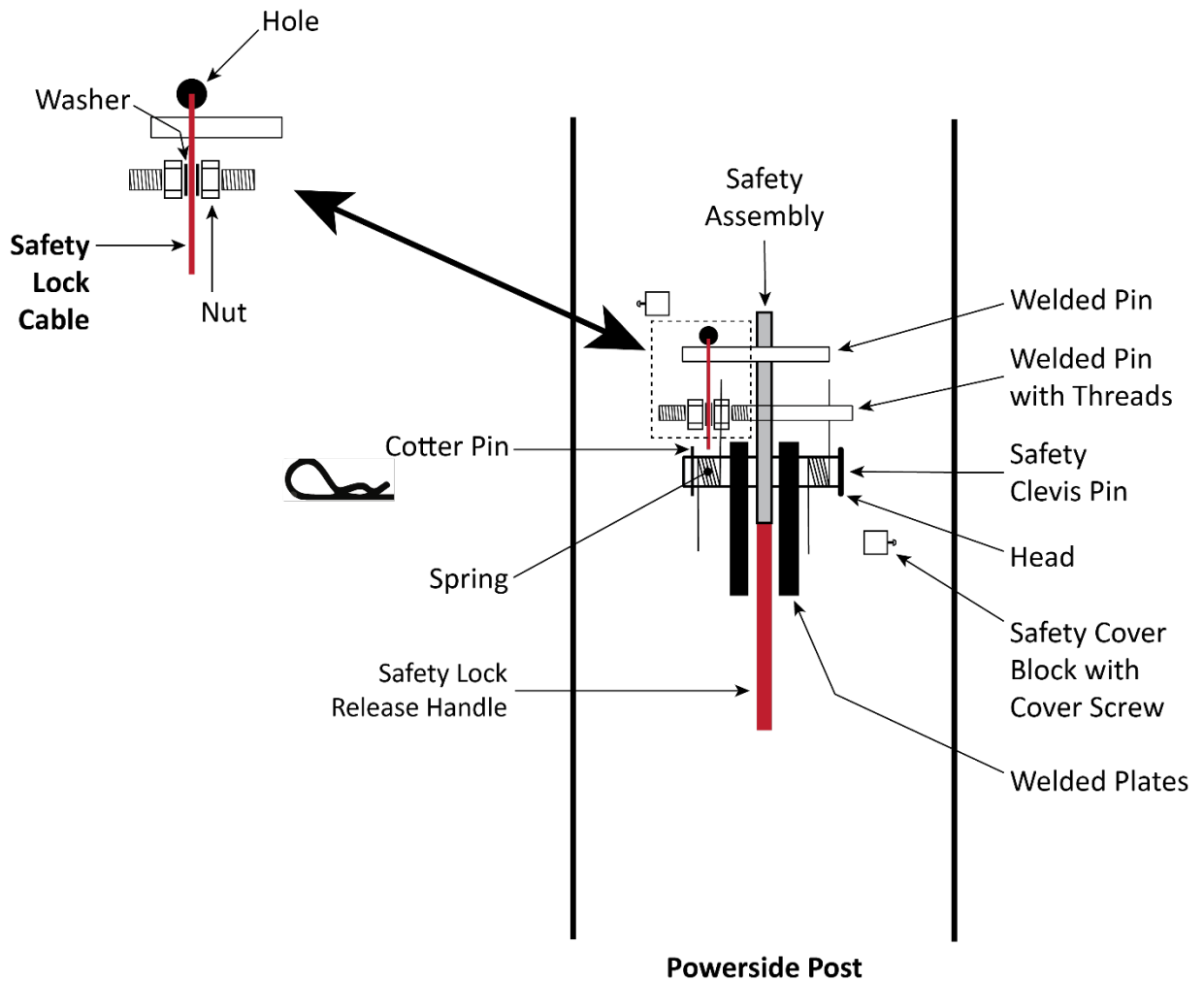

Not necessarily to scale. Not all components shown.

The Safety Assembly on the Offside Post is virtually the same as on the Powerside Post except that it does not have a handle.

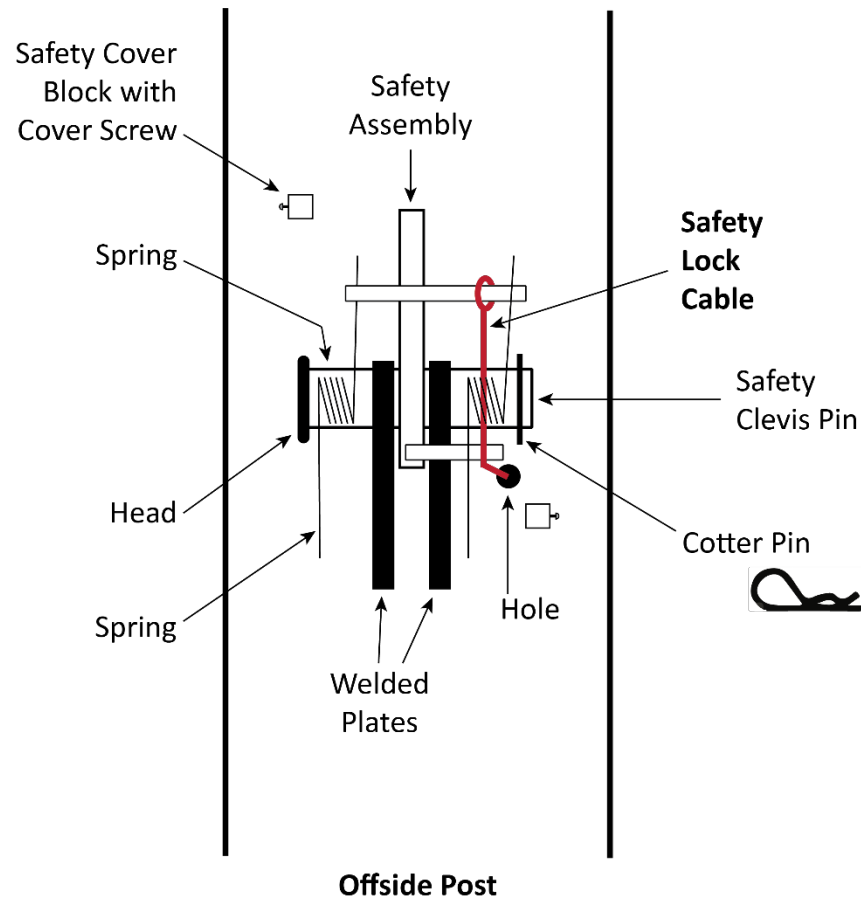

Not necessarily to scale. Not all components shown.

The procedures for the installing the Powerside Post and the Offside Post Safety Assemblies are similar, but not exactly the same.

To install the two Safety Assemblies:

1. **Starting on the Powerside Post**, locate the Safety Assembly **with** the Safety Lock Release Handle, a Safety Clevis Pin, two Springs, and one Cotter Pin.

Refer to the drawing on the previous page and above for locations of the components of the two Safety Assemblies.

2. Put one of the Springs next to the head of the Safety Clevis Pin, then insert the Safety Clevis Pin, from the left, through the hole in the left welded plate, then through the Safety Assembly, and then through the right welded plate.
3. Put the second Spring on the right end of the Safety Clevis Pin, then install the Cotter Pin on the end of the Safety Clevis Pin.

-
5. **Moving to the Offside Post**, locate the Safety Assembly **without** the Safety Lock Release Handle, a Safety Clevis Pin, two Springs, and one Cotter Pin.
 6. Put one of the Springs next to the head of the Safety Clevis Pin, then insert the Safety Clevis Pin, from the left, through the hole in the left welded plate, then through the Safety Assembly, and then through the right welded plate.
 7. Put the second Spring on the right end of the Safety Clevis Pin, then install the Cotter Pin.

The Safety Lock Cable connects the two Safety Assemblies together.

Note: The Safety Cable should have been put into place earlier, **but not attached** at either end. The following procedure describes how to hook up the Safety Cable on the Offside Post and on the Powerside Post.

To connect the Safety Lock Cable:

1. **Starting on the Offside Post**, bring the loop end of the Safety Cable down through the *inside* of the Offside Post.
2. Pull the Safety Cable out to the outside of the Offside Post.
3. Route it up and over the short, lower Welded Pin, past the Safety Clevis Pin, and loop it over the right end of the longer, higher Welded Pin.
4. **Moving to the Powerside Post**, screw two Nuts and Washers onto the threaded end of the Welded Pin with Threads. Make sure that one Nut and one Washer is on each side of the hole in the Welded Pin with Threads.
5. Bring the straight end of the Safety Cable down through the inside of the Powerside Post and pull it out to the front of the Powerside Post.
6. Put the straight end of the Safety Cable over the front of the Welded Pin and into the hole in the Welded Pin with Threads, between the two Nuts and the two Washers.
7. Pull any slack out of the Safety Cable, then tighten the Nuts.

When tightening the Nuts, keep tension on the Safety Cable and keep the Safety Cable centered between the two Nuts.

8. Operate the Safety Lock Release Handle, checking for proper operation of both Safety Assemblies.

 **DANGER** Make sure that both the Powerside and the Offside Safety Assemblies engage properly **before** using the Lift.

Connecting the Hydraulic Lines

Some of the Hydraulic Lines were put into place much earlier in the installation. It is now time to finish routing and installing them.

This section covers:

- Connecting the Elbow Fitting that connects to the Power Unit.
- Routing the Short Hydraulic Line from the Power Unit to the Tee Hydraulic Fitting.
- Routing the Long Hydraulic Line over the Overhead Assembly and to its connection point on the Powerside Post.
- Connecting the Very Short Hydraulic Line, *for Wide Configurations only*.

All XPR-10 Series Lifts use either three or four Hydraulic Lines:

- **One Short Hydraulic Line (A)**. Goes from the Power Unit up to the Tee Hydraulic Fitting on the Powerside Post; connects on the outside of the Post. Not yet installed.
- **One Medium Hydraulic Line (B)**. Goes from the Tee Fitting on the inside of the Powerside Post down to the bottom of the Powerside Hydraulic Cylinder. Already installed.
- **One Long Hydraulic Line (C)**. Goes from the inside of the Powerside Post above the Tee Fitting, over the Overhead Assembly, and down the Offside Post to the bottom of the Offside Hydraulic Cylinder. Already connected to the Hydraulic Cylinder, but not yet routed over the Overhead Assembly to the Tee Fitting.
- **One Very Short Hydraulic Line (D)**. Goes on the inside of the Powerside Post, connecting to the Tee Fitting and then to the long Hydraulic Line; ***for Wide Configurations only***. Without this extension, the Long Hydraulic Line would not be long enough for Wide Configurations. This Line is ~13" for Symmetric Lifts, ~8" for Asymmetric Lifts. ***Not used for Narrow Configurations***. Not yet installed.

All Hydraulic Lines and Hydraulic Fitting locations are shown in the drawing below.

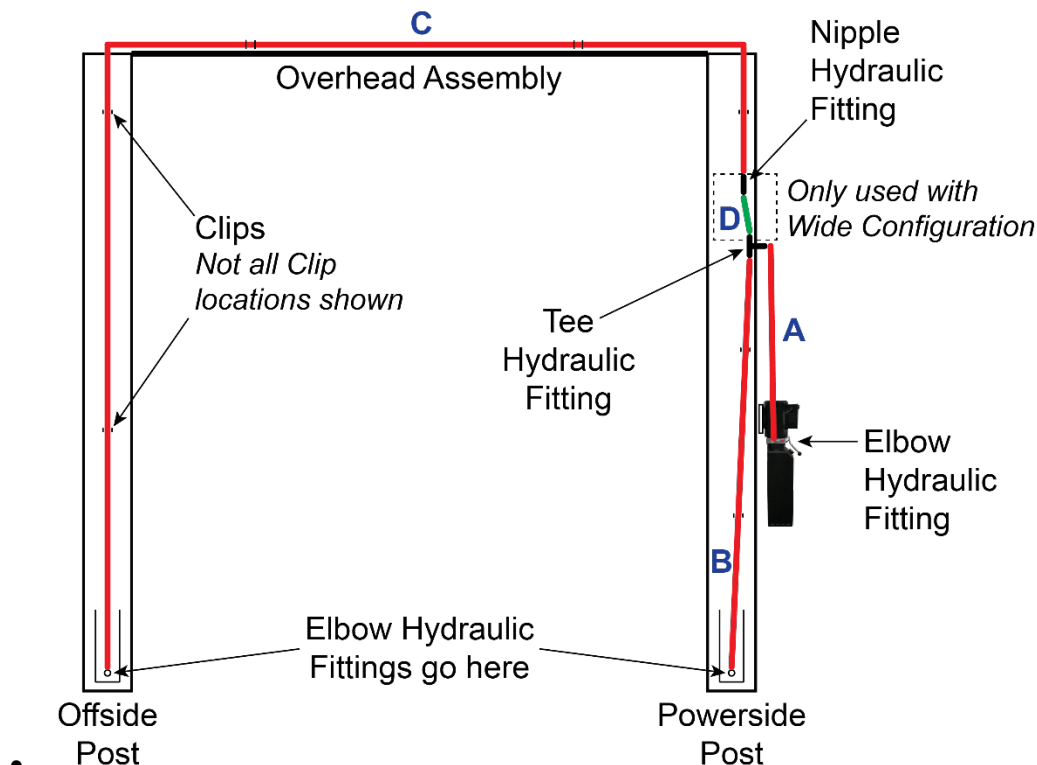

The following procedure assumes the Hydraulic Lines were put into position earlier in the installation. Refer to **Routing Hydraulic Lines** for more information. If they were **not** put into position earlier, you must do so now, **before** beginning the following procedure.

To finish connecting the Hydraulic Lines:

1. Locate the Short Hydraulic Line and the remaining Elbow Hydraulic Fitting.
All other components should already be in place. If they are not, go back and install them.
2. **On the Power Unit**, locate a hydraulic pressure out port on the Power Unit (labeled P, P1, or P2), remove the shipping plug, and install the Elbow Hydraulic Fitting (06 ORB to 06 JIC).

The following drawing shows the locations of the hydraulic pressure out ports on the Power Units that are available for the XPR-10 Series of Lifts.

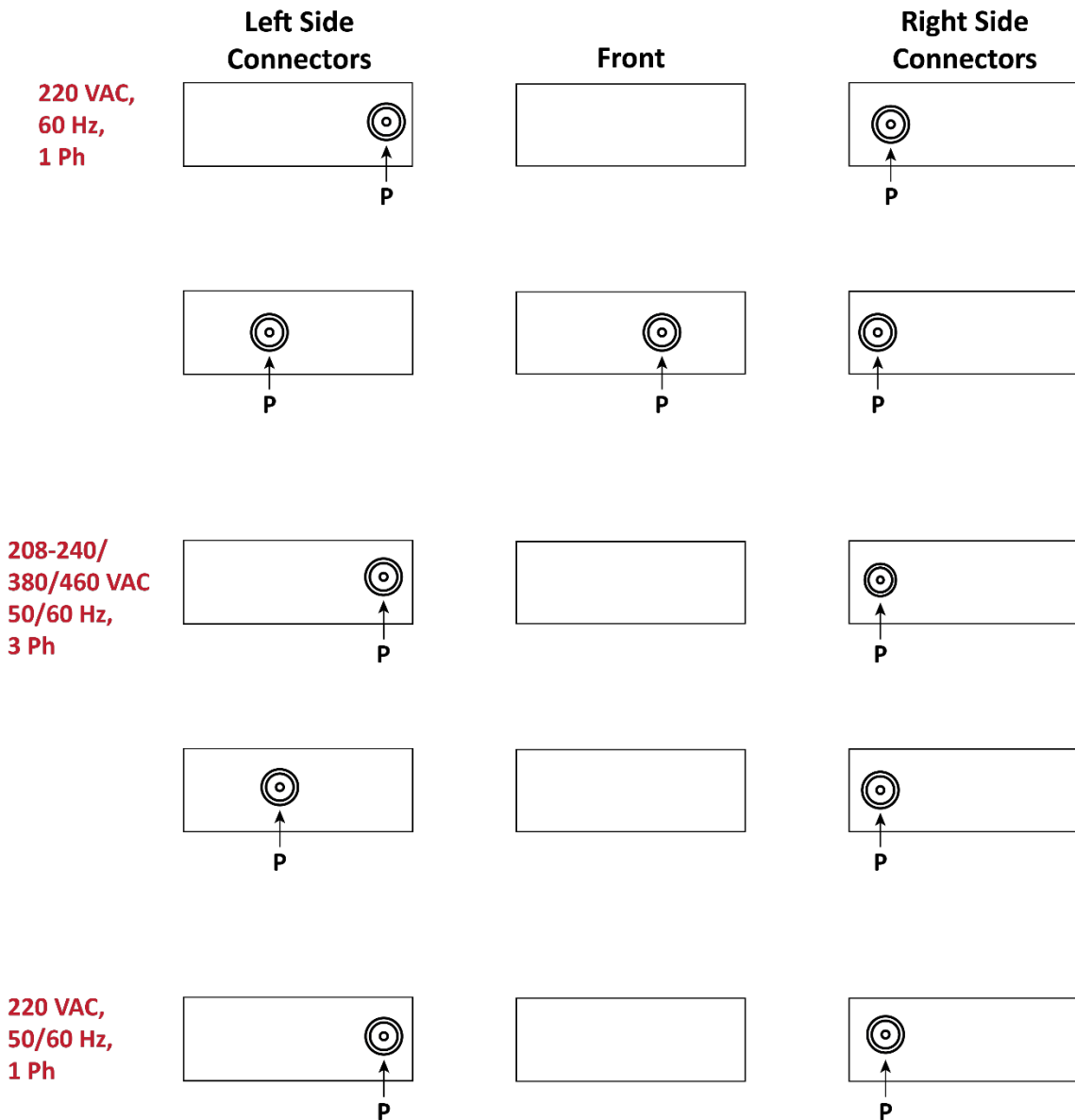

Note: There are multiple ports on the Power Units that are used with XPR-10 Series Lifts. However, each XPR-10 Series Lift uses only one hydraulic pressure out port (labeled P in the drawing above). Do not connect to any of the other ports and do not connect to more than one hydraulic pressure out port.

3. Tighten the Elbow Hydraulic fitting appropriately; make sure to leave the 06 JIC connector facing up, towards the Tee Hydraulic Fitting.

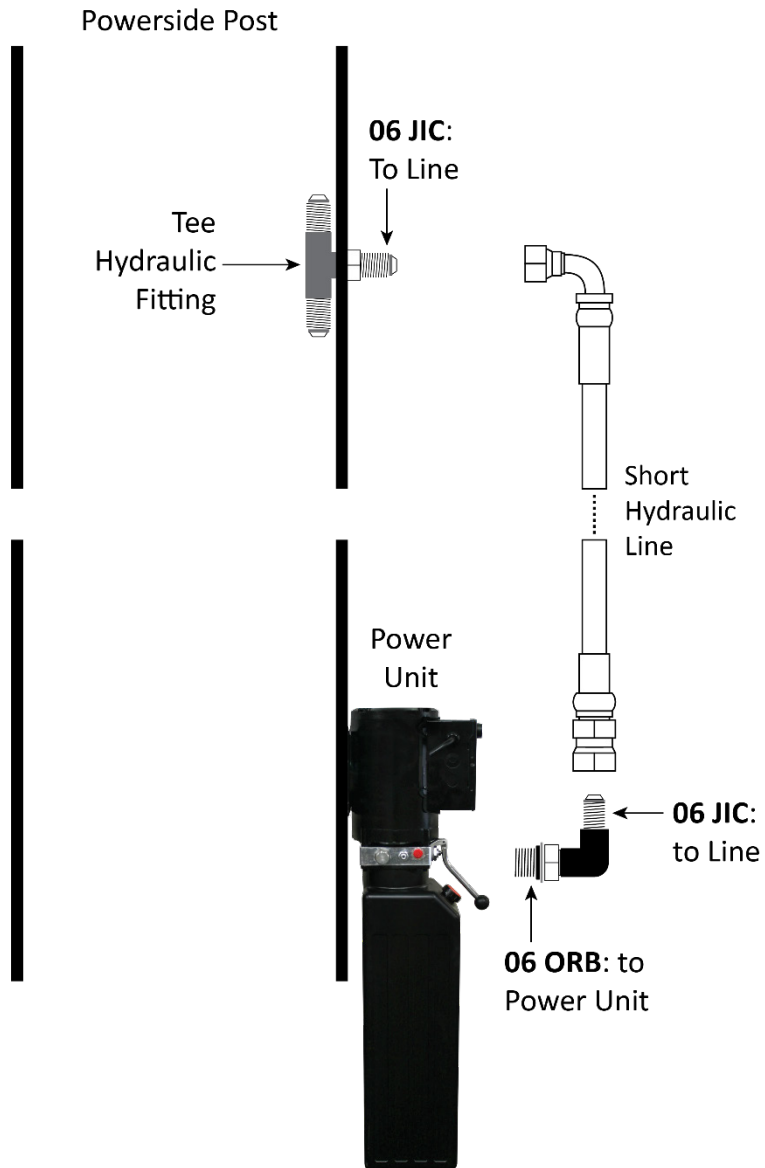

- On the Powerside Post, put the Powerside Safety Cover into place so that the Short Hydraulic Line can be routed through it. Do not fully tighten the Powerside Safety Cover in place at this point in the installation.

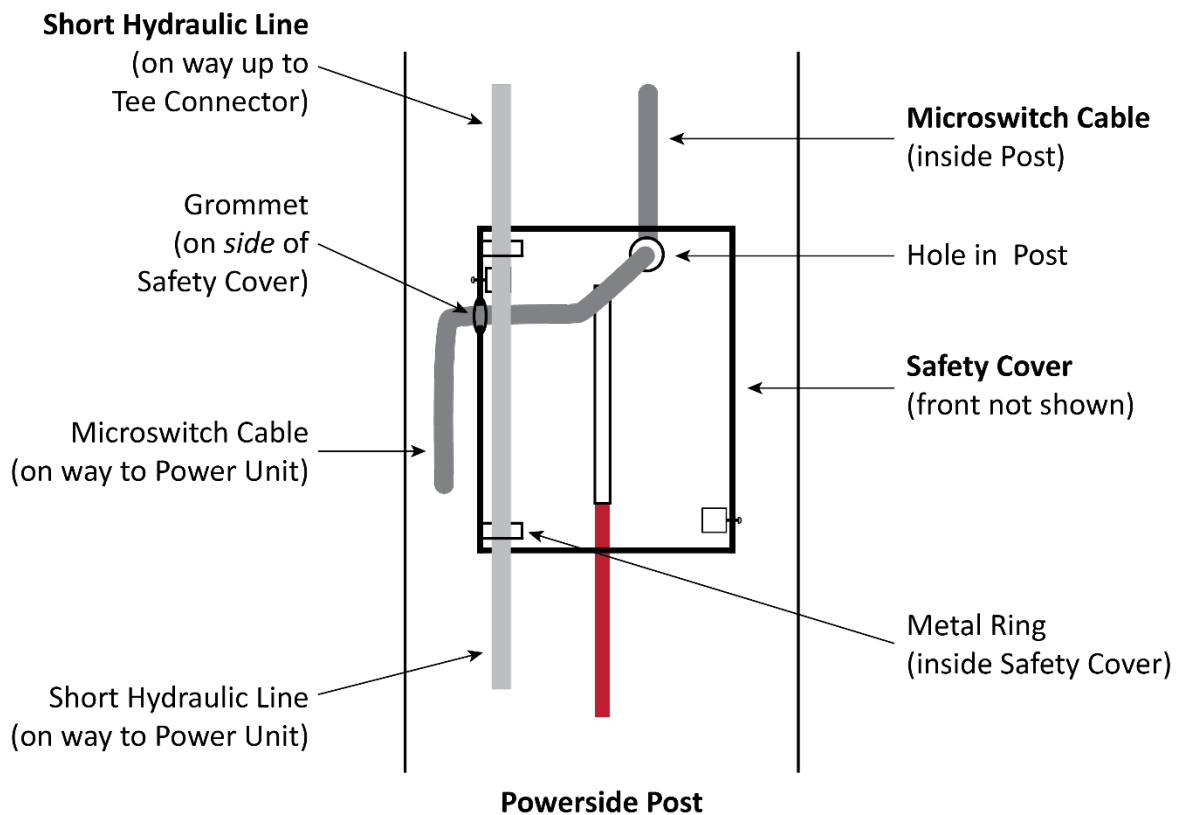

Not necessarily to scale. Not all components shown. Front of Safety Cover not shown for clarity.

- Connect the Curved End of the Short Hydraulic Line to the 06 JIC connector of the Tee Hydraulic Fitting; finger tighten the connection.

This connection is made on the outside of the Powerside Post. If the 06 JIC connector of the Tee Hydraulic Fitting is not on the outside of the Powerside Post, this means the Tee Hydraulic Fitting was not installed correctly. Return to **Routing Hydraulic Lines** for complete instructions.

- Route the Short Hydraulic Line through the two holes in the side of the Powerside Safety Cover.
- Connect the Straight End of the Short Hydraulic Line to the 06 JIC connector on the Elbow Hydraulic Fitting; finger tighten the connection.
- Use appropriate tools to securely tighten all of the finger-tightened connections.

11. **Switching to the Offside Post**, take the Long Hydraulic Line and route it over the Overhead Assembly towards the Powerside Post.
12. Make sure to put the Line through the Clips in the Posts and in the Overhead Assembly as you route the Long Hydraulic Line.
13. If you are installing the Lift in a **Wide** Configuration, you need to install the Very Short Hydraulic Line to the top of the Tee Hydraulic Fitting, and then install a Nipple Hydraulic Fitting (04 JIC to 04 JIC) to the top of the Very Short Hydraulic Line. Make sure to securely tighten each connection.

The Very Short Hydraulic Line is **not used for Narrow Configurations**.

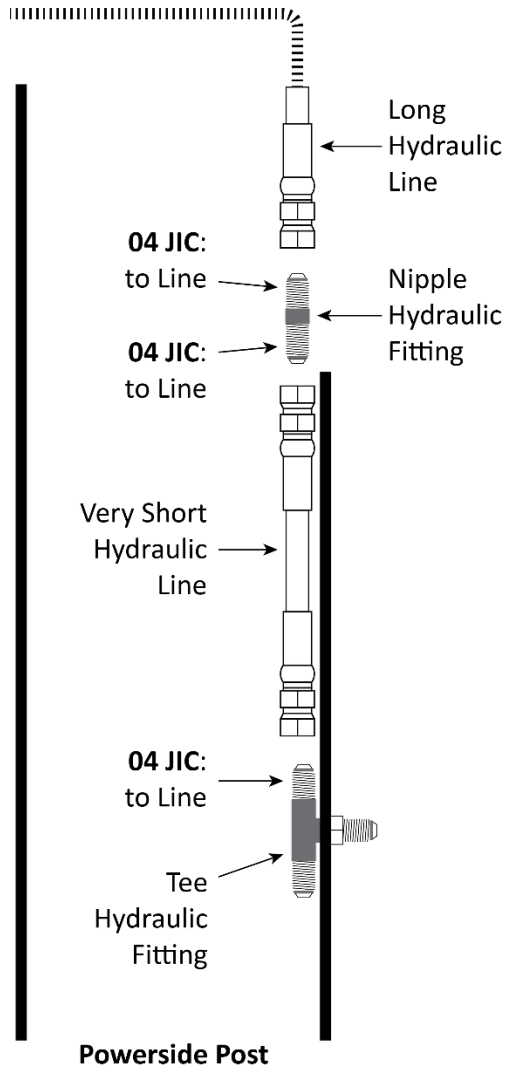

Not all components shown. Some components exaggerated for clarity.

14. Connect the Straight End of either the Long Hydraulic Line (for Narrow Configurations) or the Very Short Hydraulic Line (for Wide Configurations) to the 04 JIC connector facing up on the Tee Hydraulic Fitting; finger tighten the connection.
15. Using appropriate tools, securely tighten all of the finger-tightened connections.

Installing Lift Arms

Lift Arms are what raise Vehicles off the ground. Your Lift comes with four Lift Arms. Lift Arms come uninstalled.

There are several rules that govern which Lift Arms go where on a particular Lift.

The **first rule** is that 'short' Lift Arms get installed at the Front of the Lift and 'long' Lift Arms get installed at the Rear of the Lift.

(There is an exception to this rule: two Lift models, the XPR-10S-LP and the XPR-10XLS-LP, each have four Lift Arms of the *same length*; they can be installed at the Front or the Rear of these Lifts. The second rule still applies to them, however.)

To determine the Front and Rear of the Lift:

- **If you can only drive in one way.** The approach side is the Rear, the other side is the Front.
- **If you can drive in either way.** Choose one side as the Front and the other side as the Rear. The best way to make this decision is to pick one approach direction for the Vehicles you will be putting on the Lift, even though you can drive in either way. Once the decision is made, you approach the Lift from the Rear, so the other side is the Front.
- **If you have an Asymmetric Lift.** The 30° angled Lift Heads face the Rear of the Lift, so the other end is the Front.

The **second rule** is whether the Lift Arm is a 'right' or a 'left'. This is determined separately per Post.

To determine right and left, stand between the two Posts, then turn to face one of them straight on. From this viewpoint, the right side of the Post is the 'right' and the left side of the Post is the 'left'.

After finishing the first Post, repeat the process for the second Post.

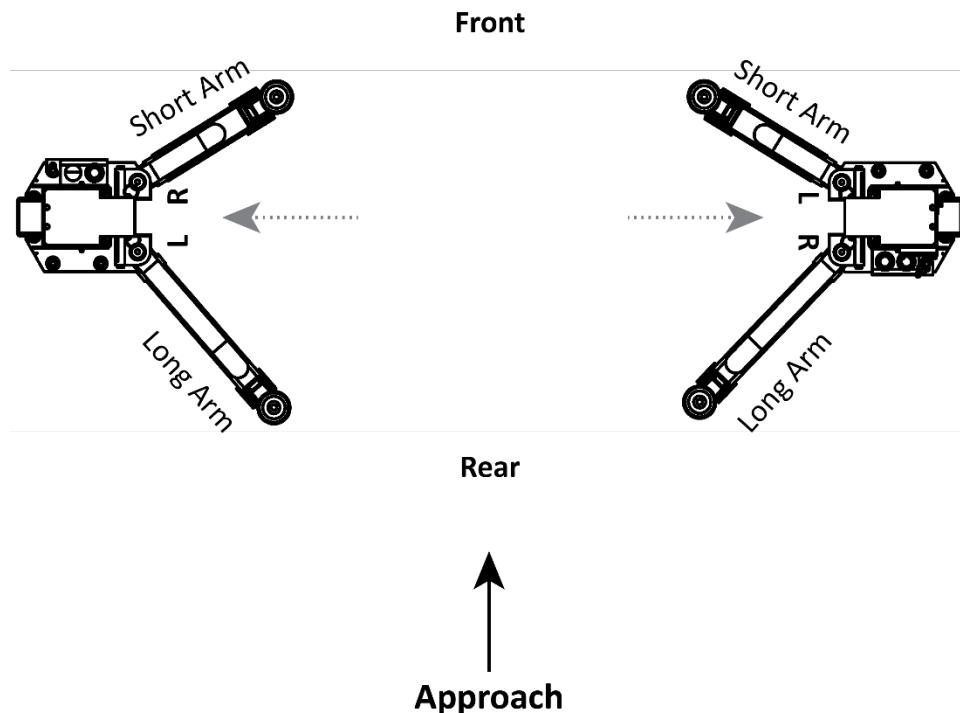

The 'left' and 'right' designation comes into play when installing the Arm Restraint Gears on a Lift Arm. Once you install an Arm Restraint Gear on a Lift Arm, that Lift Arm can only be correctly used on the side you specified it for. For example, if you install an Arm Restraint Gear on a Lift Arm as Left, then it will not work correctly if you put that Lift Arm on the Right side of a Lift Head.

To install an Arm Restraint Gear on a Lift Arm:

1. Find the Lift Arm, Arm Restraint Gear, three Bolts, three Washers, and three Split-Lock Washers.
2. Determine whether the Lift Arm is a 'left' or 'right' Lift Arm.
3. Turn the Arm Restraint Gear so that the L is facing up if the Lift Arm is a 'left' or the R is facing up if the Lift Arm is a 'right'.
4. Put the Arm Restraint Gear into place over the holes in the Lift Arm.
5. Put one of the Split-Lock Washers and Flat Washers onto a Bolt, then push that Bolt down through one of the holes in the Arm Restraint Gear and into the appropriate hole in the Lift Arm.
6. Using an appropriate tool, lightly tighten the Bolt into place.

You want the Arm Restraint Gear to stay in place, but you also want to leave a little play in it. This makes it easier to mesh the Arm Restraint Gear and the Gear Stop when you are installing the Lift Arm into a Lift Head.

7. Repeat Steps 5 and 6 for the other two Bolts.

The Lift Arm is ready to be installed into the Lift Head.

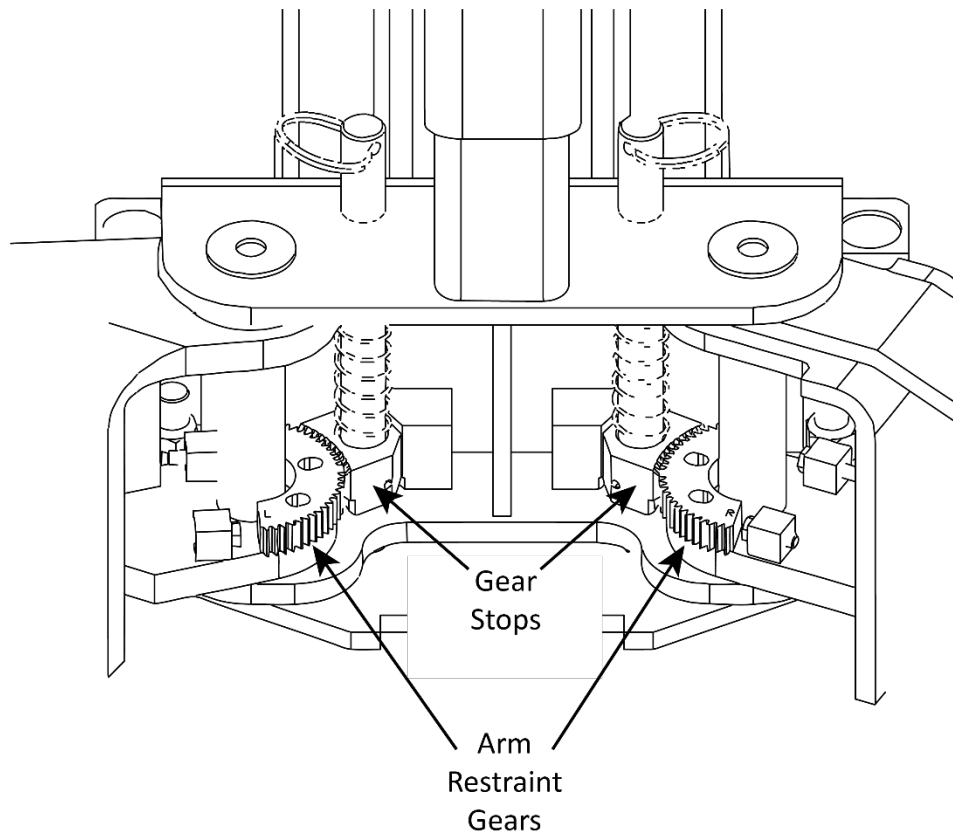

To install a Lift Arm in a Lift Head:

1. Raise the desired Lift Head at least three inches off the ground.
You need that room to work.
2. Move the appropriate Lift Arm into place in the Lift Head.
The holes at the end of the Lift Arm need to be inside the Lift Head and lined up with the holes in the Lift Head.
3. Slide a Lift Head Pin through the holes in the Lift Head and the Lift Arm.
The bottom of the Lift Head Pin needs to come out below the bottom hole in the Lift Head.
You may need to move the Lift Arm around a little to fully align the holes so that the Lift Head Pin goes through all of the holes.
4. Push a Snap Ring into its grooves on the bottom of the Lift Head Pin.
5. Make sure the Arm Restraint Gears and the Gear Stop are meshing.
6. When the Arm Restraint Gears and the Gear Stop are meshing, fully tighten the Bolts holding the Arm Restraint Gears to 60 to 70 lb ft of torque.
7. Extend the Lift Arm as far as it will go and apply approximately 150 pounds of pressure.
The Lift Arms should not move and the Arm Restraint Gears and the Gear Stop should stay meshed.
If they do not, take the Lift Arm off and start the process again.
8. Repeat these steps for the other three Lift Arms.

 **WARNING** Make sure that the Arm Restraint Gears and the Gear Stops are meshing and staying in place when up to 150 pounds of lateral force is applied before putting the Lift into normal operation.

Leveling

Before operating your Lift, you need to make sure the Lift Posts are straight and the Lift Arms are level:

- **Lift Posts:** The Posts **must** be the same distance apart at the top and at the bottom.

To make sure the Posts are straight, measure the distance between the two Posts six inches below the Overhead Assembly and one foot off the ground (you will need to move the Lift Arms out of the way). The two measurements (**A** and **B** in the drawing below) must be the same.

If the Posts are not straight, shim them as required.

- **CAUTION** If your Lift Posts are not straight or your Lift Arms are not level, this is a safety risk. The Vehicles you put on the Lift will be less secure; they could fall and cause injuries or damage to the Vehicle or to the Lift.

- **Lift Arms:** When the Lift Posts are straight, make sure the Lift Arms are level. To make sure they are level, raise them to the first locking position and put a level on the Pads.

What can you do if the Lift Arms are not level? Adjust the Equalizing Cables. Determine which Lift Arm is low, then adjust the Nut on the bottom of the Threaded End of the Equalizing Cable until the Lift Arms are level. When you believe the Lift Arms to be level, raise the Lift and listen for the Lift Heads hitting the Safety Locks (there is a distinct thump). What you want is for the thumps to be simultaneous or close to it.

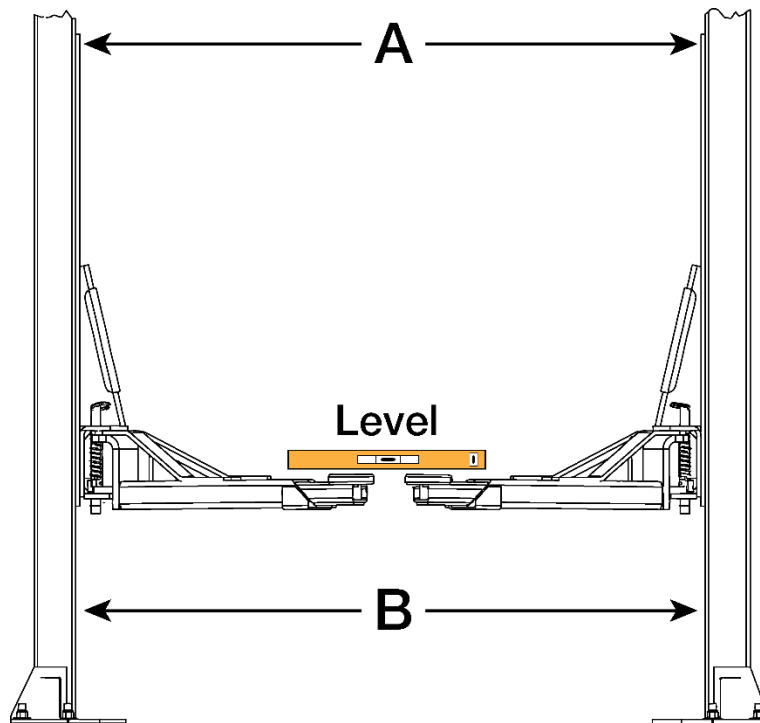

A and B distances must be the same. If they are not, shim Posts until they are.

Pads must be level. If they are not, adjust Equalizing Cables until they are.

Adjust Nut up or down to equalize Lift Heads and Pads

- **Important:** If you have **not** yet torqued the Anchor Bolts (in order to make it easier to install the Overhead Assembly and to perform final leveling), you can torque them once you have completed final leveling.

Contact the Electrician

As mentioned previously, there are installation tasks that require a certified Electrician.

⚠ DANGER All wiring **must** be performed by a licensed, certified Electrician.

The Electrician needs to:

- **Connect to power.** The Power Unit comes with a pigtail for wiring to a power source. Have your Electrician connect a power cord with plug to the electrical box on the Lift (for connection to a power outlet) or have them wire it directly into the electrical system at the Lift location.
- **Connect the Microswitch to the Power Unit.** The Microswitch (which is next to the Safety Shutoff Bar) has to be wired to the Power Unit. The necessary wiring is included.
- **Install a Power Disconnect Switch.** Ensures you can quickly and completely interrupt electrical power to the Lift in the event of an electrical circuit fault, emergency situation, or when equipment is undergoing service or maintenance. You must put it within sight and easy reach of the Lift operator. Refer to **Installing a Power Disconnect Switch** for more information.
- **Install a Thermal Disconnect Switch.** Ensures the equipment shuts down in the event of an overload or an overheated motor. Refer to **Installing a Thermal Disconnect Switch** for more information.

These installation tasks are described in detail in the following sections.

The Electrician is responsible for providing:

- A power cord and appropriate 220 VAC plug for connecting to an appropriate power source or the items required to connect to the facility's power system
- a Power Disconnect Switch
- a Thermal Disconnect Switch

Additional information is supplied in the sections describing these tasks.

Wiring the Microswitch

This section describes how to wire the Microswitch; *installing* the Microswitch was described in **Installing the Overhead Assembly, Safety Shutoff Bar, and the Microswitch**.

The Lift comes with either one or two Microswitches, depending on the Power Unit:

- **One phase Power Units.** You need only one Microswitch, which must be wired between incoming power and the Electrical Box on the Power Unit on one of the two “hot” wires.
- **Three phase Power Units.** You need two Microswitches, which must be wired between incoming power and the Electrical Box on the Power Unit on two of the three hot wires. Both Microswitches you receive are identical.

Important: If wiring *two* Microswitches, they **must** be wired on two **different** hot wires.

Refer to the diagrams in **Wiring Diagrams** for detailed Microswitch wiring information.

The following procedure assumes the Microswitch is already in place. If it is not, refer to **Installing the Overhead Assembly, Safety Shutoff Bar, and the Microswitch** to install it.

To wire a Microswitch:

1. Locate the Microswitch Cable (14/4 SJO, UL 62, 300 VAC) supplied with the Lift and the Powerside Safety Cover.
2. **On the Overhead Assembly**, appropriately connect one end of the Microswitch Cable to the Microswitch (or two Microswitches, for a 3 Phase Power Unit).

Refer to the diagrams in **Wiring Diagrams** for wiring information.

3. Route the Microswitch Cable from the Microswitch on the Overhead Assembly over to the Powerside Post, down the Powerside Post, out the hole in the Post near the top of the Safety Lock Release, through the Grommet in the Powerside Safety Cover, and to the Electrical Box on the Power Unit.

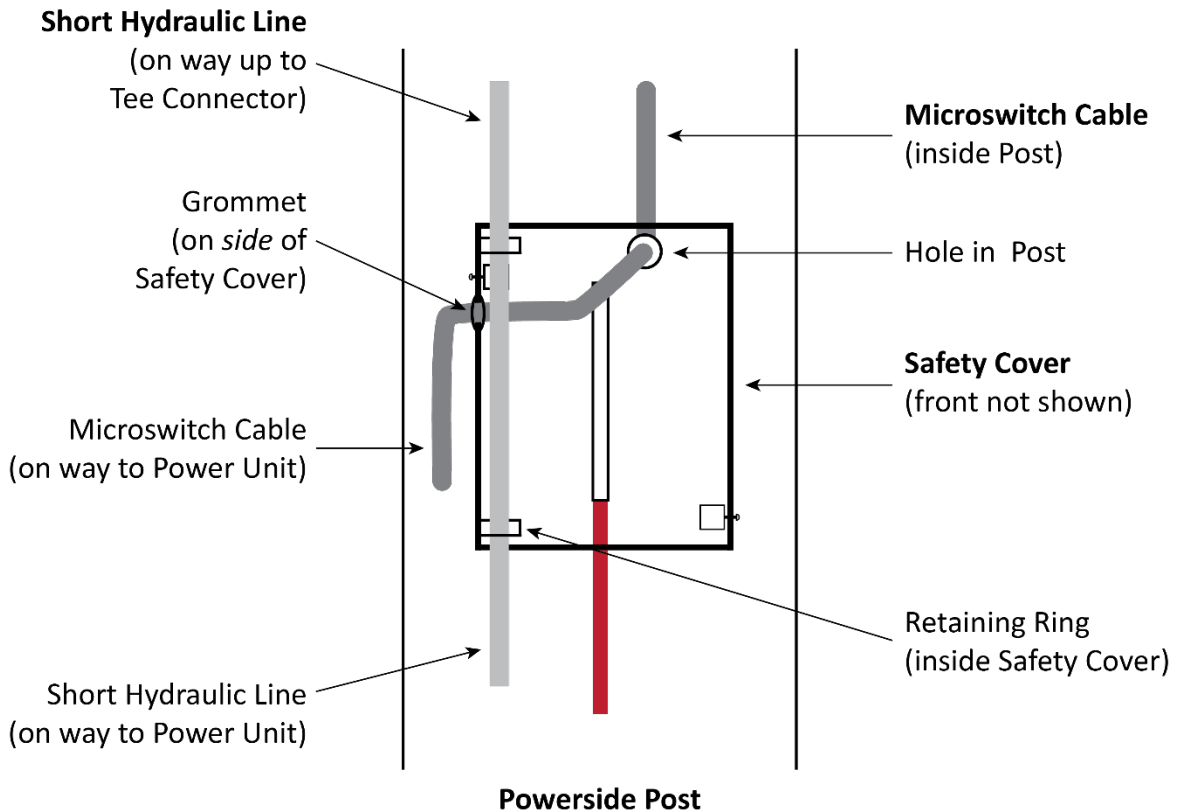

The Powerside Safety Cover should already be in place.. Do not fully tighten the Powerside Safety Cover in place at this point in the installation.

4. Once the Microswitch Cable is routed from the Microswitch to the Power Unit, clip the Microswitch Cable using the clips on the Overhead Assembly and the inside of the Powerside Post.
Clipping the Microswitch Cable in place keeps it out of the way of the other components.
5. **On the Power Unit**, open the Electrical Box and wire the Microswitch Cable per the instructions in **Connecting the Power Unit**.

Connecting the Power Unit

The Power Unit and the Microswitch must be connected to an appropriate power source.

⚠ DANGER All wiring **must** be performed by a licensed, certified Electrician. Do not perform any maintenance or installation on the Lift without first making sure that main electrical power has been disconnected from the Lift and cannot be re-energized until all procedures are complete. The Lift uses electrical energy; if your organization has Lockout/Tagout policies, make sure to implement them after connecting to a power source.

Important: Make clear to your Electrician that all electrical work **must** conform to applicable local, state, and federal codes, rules, and regulations, such as state and federal OSHA regulations and electrical codes.

There are several things you need to do to get your Power Unit ready for normal operation:

- Attach the Power Unit to the Powerside Post. Already done, described in **Mounting the Power Unit**.
- Attach the Hydraulic Line to the correct location on the Power Unit. Already done, described in **Routing Hydraulic Lines**.
- Wire the Microswitch. Already done, described in **Wiring the Microswitch**.
- Attach the Power Unit and Microswitch to a power source. Covered in this section.
- Fill the Hydraulic Fluid reservoir. Covered in this section.

Your XPR-10 Series Lift is available with one of any of the following types of Power Units:

- **220 VAC, 60 Hz, 1 Phase.** 220 VAC, for North American countries (U.S., Mexico, Canada).
- **208-240/380/460 VAC, 50/60 Hz, 3 Phase.** 3 Phase, multiple voltages available.
- **220 VAC, 50/60 Hz, 1 Phase.** 220 VAC, for countries *outside* North America.

110 VAC Power Units are **not** available for XPR-10 Series Lifts.

Specialized 3 Phase, Low RPM Power Units are also available on request.

Some Power Units are provided by different vendors so there may be minor differences in look and feel. Nevertheless, all Power Units of the same type provide the same level of functionality.

All Power Units come with a 'pigtail' coming out of the Electrical Box. To install your Power Unit, remove the pigtail and connect the Electrical Box to the electrical system at your location or to an appropriate power cord with plug.

The following drawing is a front view of a Power Unit. Your particular Power Unit may look somewhat different based on what type you purchased.

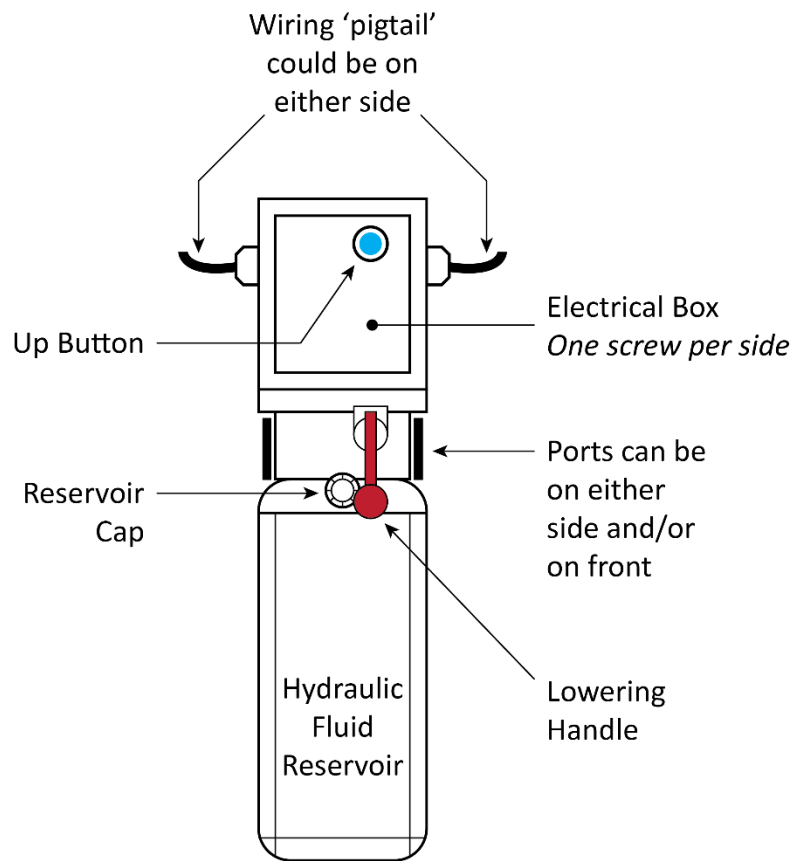

Not necessarily to scale. Your Power Unit may be slightly different.

Note: The Up Button shown in the drawing above could be in a different location on the unit or could be a switch instead of a button, depending on the Power Unit you have.

Make clear to your Electrician that all electrical work **must** conform to applicable local, state, and federal codes, rules, and regulations, such as state and federal OSHA regulations and electrical codes.

To connect the Power Unit:

1. Have the Electrician locate the Pigtail coming out of the Electrical Box on the Power Unit.
2. Open the Electrical Box, remove the Pigtail, and then either:
 - Wire the Power Unit directly into the facility's electrical system.
 - Wire a power cord (with appropriate plug) *inside the Electrical Box* to the wiring that was connected to the Pigtail.

Wiring information is either on the outside of the Power Unit under the Electrical Box or inside the cover of the Electrical Box. Have the Electrician use that wiring information to wire the Power Unit to the power source.

3. Wire the Microswitch(es) into the incoming power.

Refer to **Wiring Diagrams** for wiring information.

4. Fill the Hydraulic Fluid reservoir with approved Hydraulic Fluid.

The reservoir holds ~3.5 gallons of Hydraulic Fluid, depending on which Power Unit you have.

When you receive the Power Unit, the reservoir is empty; you need to fill it.

Approved Hydraulic Fluids are any general purpose ISO-32, ISO-46, or ISO-68 hydraulic oil or approved automatic transmission fluids such as Dexron III, Dexron VI, Mercon V, Mercon LV, Shell Tellus S4 / S3 / S2, or any synthetic multi-vehicle automatic transmission fluid.

 **WARNING** Do not run the Power Unit without Hydraulic Fluid; you will damage it.

Important electrical information:

- Improper electrical installation can damage the Power Unit motor; this damage is **not** covered by the warranty.
- Use a separate circuit breaker for each Power Unit.
- Protect each circuit with a time-delay fuse or circuit breaker.
 - For a 220 VAC, single phase circuit, use a 25 amp or greater fuse.
 - For a 208-230 VAC three phase circuit, use a 20 amp or greater fuse.
 - For a 380 or 440 VAC three phase circuit, use a 15 amp fuse.
- As you require an Electrician on site to connect the Power Unit to a power source, you might also want to have them install the Power Disconnect Switch and the Thermal Disconnect Switch on the same visit.

 **DANGER** Risk of explosion: This equipment has internal arcing or parts that may spark and should not be exposed to flammable vapors. The Power Unit's motor should not be located in a recessed area or below floor level. Never expose the motor to rain or other damp environments; damage to the motor caused by water is not covered by the warranty.

Installing a Power Disconnect Switch

WARNING

A Power Disconnect Switch is **not** provided with this equipment.

A Power Disconnect Switch is a National Electrical Code (NEC) requirement. They are designed to interrupt main electrical power in the event of an electrical circuit fault, emergency situation, or when equipment is undergoing service or maintenance.

Make sure to install a Power Disconnect Switch that is properly rated for the incoming power source.

Your Power Disconnect Switch must be readily accessible and installed so that it is in easy reach of the operator or in their line of sight. The Power Disconnect Switch must be clearly marked to indicate its purpose.

The figure to the right shows a toggle-style Power Disconnect Switch located between the Lift's power source and its Power Unit. A quick flip of the switch immediately cuts power to the Lift.

In the case of the XPR-10 Series, the location directly above the Power Unit is being used by the Lowering Handle, so your Electrician may want to move the Power Disconnect Switch location up a little.

 **DANGER** Installing a Thermal Disconnect Switch **must** be performed by a licensed, certified Electrician.

Have the Electrician select a **UL-listed** Power Disconnect Switch.

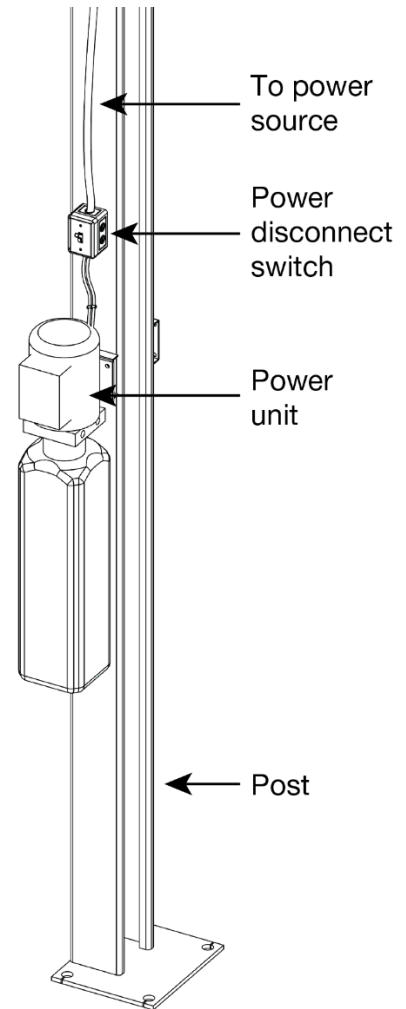

Installing a Thermal Disconnect Switch

 **WARNING** An XPR-10 Series Lift motor has **no** thermal overload protection.

Have the Electrician connect a motor Thermal Disconnect Switch or overload device that will make sure the equipment shuts down in the event of an overload or an overheated motor.

 **DANGER** Installing a Thermal Disconnect Switch **must** be performed by a licensed, certified Electrician. Do not perform **any** maintenance or installation on the Lift without first making sure that main electrical power has been disconnected from the Lift and **cannot** be re-energized until all procedures are complete.

High running amps that exceed the motor's full load amps (FLA) rating may result in permanent damage to the motor.

BendPak strongly recommends you **not** exceed the rated duty cycle of the Lift motor.

Installing the Safety Covers

There are two Safety Covers, one for each Safety Assembly, on the outside of each Post.

Refer to [Installing the Safety Assemblies and the Safety Lock Cable](#) for more information about installing the Safety Assemblies.

The Safety Covers are **not** interchangeable:

- The Offside Safety Cover can be installed in either orientation. It does not have a slot.
- The Powerside Safety Cover can only be installed in one orientation: there is a slot on the front for the Safety Lock Release Handle and a hole on the left side for the Microswitch Cable.

By the time you get to this section of the installation, the Powerside Safety Cover will be in place but not fully installed. The Powerside Safety Cover is in place already because both the Short Hydraulic Line and the Microswitch Cable were routed through it on their way to the Power Unit.

Both Safety Covers connect to their Posts via blocks in the upper left and lower right corners.

To install the Safety Covers:

1. Locate the two Safety Covers and four Cover Screws.
2. **On the Offside Post**, install the Cover Screws in each block.
Do not fully tighten the Cover Screws into the block: there must be enough space between the block and the Cover Screws to slide in the Safety Cover.
3. Slide the Safety Cover into position, then fully tighten both Cover Screws into their blocks so that the Safety Cover is held securely.
4. **On the Powerside Post**, install the Cover Screws in each block.
Do not fully tighten the Cover Screws: there must be enough space between the block and the Cover Screws to slide in the Safety Cover.
5. Make sure the Microswitch Cable and the Short Hydraulic Line are correctly routed through the Powerside Safety Cover and the Safety Lock Release Handle is usable through the slot on the front.
6. Fully tighten both Cover Screws into their blocks so that the Safety Cover is held securely.

Lubricating the Lift

XPR-10 Series Lifts work better and longer if you keep them lubricated.

Lubricate the following:

- Cable sheave pins, with WD-40 or equivalent.
- Safety pins, with WD-40 or equivalent.
- The four inside corners of both Posts, with light axle grease.

Perform an Operational Test

Before putting your Lift into normal operation, we recommend raising and lowering it several times with a typical Vehicle on the Lift. This will help you get a feel for how to operate the controls and help get any residual air out of the Hydraulic System (sometimes called “bleeding” the system).

 **DANGER** Automotive Lifts are dangerous tools when used by inexperienced or impaired technicians. When you even hear the words “automotive lift,” your brain should automatically register the fact that lifting a vehicle is a serious endeavor with life-threatening risks if mandatory lifting precautions are ignored.

During the Operational Test, check for proper installation and operation. Do not raise any additional Vehicles until a thorough Operational Test has been done with a typical Vehicle.

 **WARNING** Never raise a Vehicle whose weight exceeds the rated capacity of the Lift. Do not leave the controls until the Lift is engaged on its Safety Locks. Only trained personnel should raise or lower the Lift.

To perform an Operational Test:

1. Follow the instructions in **Raising a Vehicle** and **Lowering a Vehicle** to safely raise and lower a Vehicle on the Lift.

 **WARNING** Be sure to follow the instructions carefully when it comes to contacting the manufacturer’s recommended Lifting Points on the underside of the Vehicle. If you do not, the Vehicle could become unstable and fall, which could damage the Vehicle, damage the Lift, and injure or even kill anyone under the Vehicle.

2. Adjust the Lift Arms under the Vehicle so the Adapters are **directly under** the Lifting Points for the Vehicle you are raising.

If necessary, use the included Auxiliary Adapters for extra height.

3. Raise the Lift until **just before** the Adapters make contact with the Lifting Points.
4. Check the Arm Restraint Gears on all four Lift Arms to make sure they are engaged.

If they are not engaged, move the Lift Arms back and forth until they engage.

5. Raise the Lift until the tires of the Vehicle are a few inches off the ground.
6. Check to make sure all four Adapters are making solid contact with the Lifting Points.

If any of the Adapters are **not** making solid contact with the Lifting Points, carefully lower the Lift and start over again; the Adapters **must** make solid contact with the Lifting Points.

7. Raise the Vehicle approximately three feet (one meter) off the ground, then lower it back down.

Watch and listen as the Lift raises and then lowers. The Lift may move erratically or make some odd noises the first couple of times you use it; this is normal.



Tip

Residual air in the Hydraulic System can cause the Lift to shake, move erratically, or squeak; this is normal when you first start using the Lift. It will soon stop doing this, as the Hydraulic System is self-bleeding.

8. Wait for one minute.

NOTICE The Power Unit is not a constant duty motor; **it cannot be run continuously.**

-
9. Repeat the process, this time raising the Lift, engaging it on a Safety Lock position, taking it off the Safety Lock position, and then lowering it back down to the ground.
Again, follow the instructions in **Raising a Vehicle** and **Lowering a Vehicle** to safely raise and lower a Vehicle on the Lift, including engaging it on its Safety Locks.
 10. If the Lift is working without shaking, moving erratically, or squeaking, there is no need to repeat the procedure.
If the Lift is shaking, moving erratically, or squeaking, repeat the procedure one more time.
If you continue to have issues, refer to **Troubleshooting** for assistance.
 11. When the Lift is on the ground and the Vehicle is on all four tires, move the four Lift Arms to their full drive-through positions.
 12. Drive the Vehicle out.
 13. With no Vehicle on the Lift Arms, press and hold the Up button on the Power Unit.
The Lift Arms start rising.
 14. Have another person push up the Safety Shutoff Bar until it triggers the Microswitch.
The Lift Arms should stop rising.
If the Lift Arms do not stop rising when the Microswitch is triggered, this means the Microswitch is either not installed correctly or not wired correctly. Return to the sections of this manual where installation and wiring of the Microswitch is described to find and fix the problem.

 **CAUTION** Do not put the Lift into normal operation until you have confirmed that triggering the Microswitch stops the Lift Arms from rising.

Review Final Checklist Before Operation

Make sure these things have been done before putting the Lift into normal operation:

- Review the **Installation Checklist** to make sure all steps have been performed.
- Make sure the Power Unit is getting power from the power source.
- Check the Hydraulic Fluid reservoir; it must be full of approved Hydraulic Fluid or automatic transmission fluid. **You can harm the motor by running it without enough fluid.**
- Check the Hydraulic System for leaks.
- Make sure both Posts are properly plumbed, shimmed, and stable.
- Check to see that all Anchor Bolts are correctly torqued.
- Apply light axle grease to the inside of the Posts where the Slide Blocks move.
- Make sure both Carriage Bolts are in place and tightened near the top of both Posts.
- Make sure all Cables are properly positioned in their Sheaves.
- Make sure all Cable Sheave retaining pins and/or clips are secure.
- Make sure both Safety Assemblies are connected and working normally.
- Make sure that all Safety Locks are clear and free.
- Make sure an Operational Test has been done.

Leave the Manual

Make sure to leave the *Installation and Operation Manual* with the owner/operator.

Operation

This section describes how to operate your Lift.

 **DANGER** Automotive Lifts are dangerous tools when used by inexperienced or impaired technicians. When you even hear the words “automotive lift,” your brain should automatically register the fact that lifting a vehicle is a serious endeavor with life-threatening risks if mandatory lifting precautions are ignored.

Lift Operation Safety Rules

Important: Your safety is dependent on reading, understanding, and implementing these Safety Rules. ***Do not skip over them; read them carefully and follow them!***

Do the following before you raise or lower a Vehicle on your Lift:

- **Check the Lift.** Check the Lift for any missing, heavily worn, or damaged parts. Do not operate the Lift if you find any issues; instead, take it out of service, contact your dealer, email techsupport@bendpak.com, or call **(800) 253-2363**.
- **Check the area.** Keep the area around the Lift clean and free of obstructions; anything that could cause a problem for the Lift. Do not forget to check **above** the Lift. If you find an obstruction, move it out of the way. Do not allow any people or animals within 30 feet of the Lift while it is in motion.
- **Check the operators.** Make sure that everyone who is going to operate the Lift has been trained in its use, has read the labels on the unit, and has read the manual. Only the operator should be within 30 feet of the Lift when it is in motion. Do not allow children to operate the Lift. Do not allow anyone under the influence of drugs or alcohol to operate the Lift.
- **Check for safety.** Make sure everyone who is going to be walking near the Lift is aware of its presence and takes appropriate safety measures. Only put Vehicles on the Lift Arms. ***When raising a Vehicle on the Lift, do not leave it until it is positioned on Safety Locks.*** When lowering the Lift, do not leave it until it is on the ground.
- **Check the Vehicle.** Never exceed the Lift’s weight rating. Do not allow people inside a Vehicle you are going to raise. Make sure the Vehicle is not overbalanced on either end. Make sure you know the manufacturer’s recommended Lifting Points for the Vehicle. Never raise just one side, one corner, or one end of a Vehicle.

 **WARNING** Always use care when you are around your Lift. When it is in a lowered position, be careful not to trip over it. When it is raised, be careful not to bang your head on the Lift Arms or the Vehicle. ***When you are raising or lowering a Vehicle, keep all people, animals, and objects at least 30 feet away from the Lift.***

About Lifting Points, Adapters, and Auxiliary Adapters

All of the Lifts in the XPR-10 Series are frame-engaging Lifts, which means that the Lift uses its four Lift Arms to raise Vehicles by their frames. This leaves the Wheels of the Vehicle free to be worked on.

One of the most important things to keep in mind when using a frame-engaging Lift is that the raised Vehicle needs to be balanced on the four Lift Arms. If the Vehicle is not balanced, it is more likely to become unstable and slide off the Lift, possibly damaging the Lift, the Vehicle, and anything under the Lift, including injuring people.

⚠ WARNING You **must** use all four Lift Arms when raising a Vehicle. Never use just one, two, or three Lift Arms to raise a Vehicle. The Vehicle will be unstable and could slip off the Lift, possibly damaging the Lift, damaging the Vehicle, and injuring anyone under it.

To balance a Vehicle on a frame-engaging Lift, you need to have the Adapters (also called Pads) contact the Vehicle on the manufacturer's recommended Lifting Points. By definition, when you raise a Vehicle by its Lifting Points, the Vehicle is balanced.

Important: The manufacturer's recommended Lifting Points do not take into consideration any major changes that might have been made to the Vehicle. If the motor is removed, for instance, or there is a 5,000 pound / 2,268 kg weight in the trunk, the Vehicle's Lifting Points will not be the best balancing points.

So how do you find the manufacturer's recommended Lifting Points? Some Vehicles have indicators on the underside that identify the Lifting Points; many do not.

Your best approach is to find the Vehicle in the book *Vehicle Lifting Points for Frame Engaging Lifts*, which was provided with your Lift, or contact the manufacturer of the Vehicle. The book also includes a page of safe lifting suggestions, which everyone who uses the Lift should read.

The book *Lifting it Right: A Safety Manual from the Automotive Lift Institute*, also provided with your Lift, includes a wide variety of information about Lifts and how to use them safely.

The Adapters and Auxiliary Adapters (also called height adapters or extenders) included with every XPR-10 Series Lift are:

- **Four Screw Lift Pads.** Best suited for Vehicles with Unibody constructions; they are also adjustable up to 3".
- **Four 2.5" / 63 mm Auxiliary Adapters.** Let you raise the height of your Auxiliary Adapters to make better contact with Vehicles.

Optional accessories for your XPR-10 Series Lift include:

- **Four Frame Cradle Pads.** Best suited for trucks, SUVs, and other Vehicles with Frame constructions. Highly recommended for raising these types of Vehicles correctly and safely.
- **Four 1.75" / 44 mm Auxiliary Adapters.** Let you raise the height of your Auxiliary Adapters.
- **Four 5" / 125 mm Auxiliary Adapters.** Let you raise the height of your Auxiliary Adapters.

⚠ WARNING You can stack Auxiliary Adapters, but only up to 9". If you stack Auxiliary Adapters above 9", the Vehicle could become unstable and slip off the Lift, possibly damaging the Lift, damaging the Vehicle, and injuring anyone under it.

Raising a Vehicle

This section describes how to raise a Vehicle on your XPR-10 Series Lift.

⚠ WARNING: Never raise a Vehicle whose weight exceeds the rated capacity of the Lift. Do not leave the controls until the Lift is engaged on a Safety Lock position or fully lowered. Only trained personnel should raise and lower the Lift.

To raise a Vehicle:

1. Make sure all four Lift Arms are on the ground in their full drive-through positions.
2. Check under the Vehicle you are going to raise, check for the type of vehicle frame, and then put the most appropriate Adapters on the Lift Arms.

If you are lifting a sedan or a Vehicle with a unibody construction, a Screw Lift Pad is generally the best choice. If you are lifting an SUV, truck, or other Vehicle with a frame construction, a Frame Cradle Pad is generally the best choice.

⚠ WARNING: Always use the Adapter type best suited for the Vehicle you are raising. If you use the wrong Adapter type, the Vehicle could become unstable.

3. Drive the Vehicle in.

⚠ CAUTION When driving a Vehicle into position, keep to the middle of the area between the Posts. If you hit a Lift Arm or any other portion of the Lift, you could damage the Vehicle and/or the Lift.

4. When you are satisfied with the location of the Vehicle, put it in park, put on the parking brake, and turn off the motor.

If the Vehicle is a manual transmission, put it into first gear before turning off the motor.

5. Get out of the Vehicle; open the doors carefully to avoid banging them on the Lift.
6. Locate the manufacturer's recommended Lifting Points for the Vehicle you are raising.

If you are unsure where the Lifting Points are, consult *Vehicle Lifting Points for Frame Engaging Lifts*, which was provided with the Lift, or the manufacturer of the Vehicle. If you no longer have *Vehicle Lifting Points for Frame Engaging Lifts*, contact BendPak Support email techsupport@bendpak.com or call **(800) 253-2363** to get a replacement copy.

⚠ WARNING: Do not 'eyeball' the best location for the Adapters. ***You must use the manufacturer's recommended Lifting Points.*** If you do not, the Vehicle could become unstable and fall, which could damage the Vehicle, damage the Lift, or injure or even kill anyone under the Vehicle.

7. Adjust the Lift Arms under the Vehicle so the Adapters are ***directly under*** the Lifting Points for the Vehicle you are raising.

If necessary, use the included Auxiliary Adapters for extra height.

8. Raise the Lift until ***just before*** the Adapters make contact with the Lifting Points.
9. Check the Arm Restraint Gears on all four Lift Arms to make sure they are engaged.

If they are not engaged, move the Lift Arms back and forth until they engage.

10. Raise the Lift until the tires of the Vehicle are a few inches off the ground.
11. Check to make sure all four Adapters are making solid contact with the Lifting Points.

If any of the Adapters are **not** making solid contact with the Lifting Points, carefully lower the Lift and start over again; the Adapters **must** make solid contact with the Lifting Points.

12. Rock the Vehicle to make sure the Vehicle is stable and balanced.

If the Vehicle is **not** stable and balanced, lower the Lift back to the ground and start over.

If the Vehicle **is** stable and balanced, you can raise it to the desired height.

⚠ DANGER Do not raise the Lift further until you are certain the Vehicle on the Lift is both stable and balanced. If the Vehicle is **not** stable and balanced, it could fall, which could damage the Vehicle, damage the Lift, or injure or kill anyone under the Vehicle.

13. Press and hold the Up Button.

14. Listen as the Lift passes the Safety Locks; you should hear each side pass by the Safety Locks at approximately the same time.

15. When the Vehicle reaches the desired height, go past the next Safety Lock position (you will hear the clank as it passes), then release the Up Button.

16. Press and hold the Lowering Handle, which lowers the Lift onto the Safety Lock position you just passed. (Do not hold the Safety Lock Release Handle, that is for lowering the Lift to the ground.)

17. When the Lift stops moving down, it is engaged on its Safety Locks; release the Lowering Handle.

Do not leave the Lift controls unless the Lift is engaged on its Safety Locks or fully lowered.

18. Recheck the Adapters to make sure they are all still making solid contact with the Lifting Points.

19. Make sure the Lift is engaged on the same Safety Lock on both Posts. You do not want the Lift engaged on Safety Locks of two different heights or one Safety Lock engaged but the other not.

20. Begin work on the Vehicle.

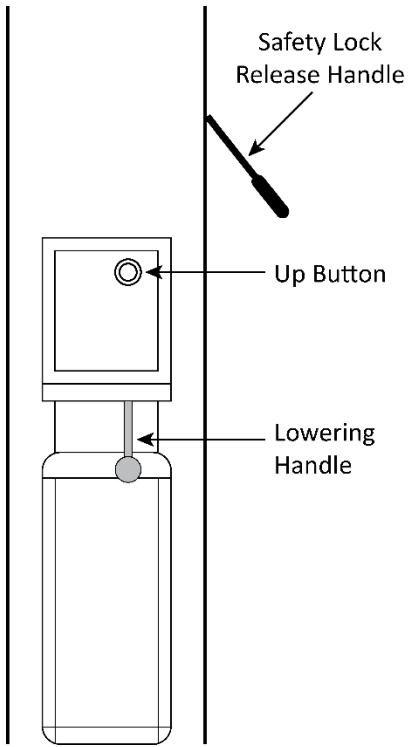
<p>To raise Lift:</p> <ol style="list-style-type: none">1. Press and hold Up Button.2. When Lift is just past desired height, release Up Button.3. Press and hold Lowering Handle. <p><i>Do not press and hold the Safety Lock Release Handle. If you do, the Lift will continue to lower and will not engage on its Safety Locks.</i></p> <p>Lift engages on its Safety Locks and stops moving; release Lowering Handle when Lift stops.</p> <p><i>Only leave Lift on Safety Locks or fully lowered.</i></p>	 <p>The diagram shows a vertical control panel for a lift. At the top is a diagonal handle labeled 'Safety Lock Release Handle'. Below it is a circular button labeled 'Up Button'. At the bottom is a horizontal handle labeled 'Lowering Handle'. A vertical line represents the lift's path, with a small circle indicating the lift's position between the Up Button and Lowering Handle.</p>	<p>To lower Lift:</p> <ol style="list-style-type: none">1. Press and hold Up Button for two to three seconds. This moves Lift off its Safety Locks.2. Press and hold Safety Lock Release Handle and Lowering Handle. Lift begins lowering.3. When Lift is fully lowered, release Safety Lock Release Handle and Lowering Handle. <p><i>Only leave Lift on Safety Locks or fully lowered.</i></p>
--	---	--

Lowering a Vehicle

To lower a Vehicle off the Lift, you first raise it a small amount to get it off its Safety Locks, then lower it.

To lower a Vehicle off the Lift:

1. Check under and around the Vehicle to make sure the area is clear of all obstructions.
If you find any obstructions, move them out of the way.
2. Press and hold the **Up** Button for a second or two to move the Lift off its Safety Locks.
Raise the Lift at least two inches to get clear of the Safety Locks.
3. Push and hold the Safety Lock Release Handle (on the Powerside Post above and to the right of the Power Unit).
4. Push and hold the Lowering Handle (on the front of the Power Unit).

Important: Both the Safety Lock Release Handle *and* the Lowering Handle must be held down at the same time to lower the Lift.

The Lift begins lowering.

 **WARNING:** Do not override the Lift controls; for safety purposes, they are designed to stop the Lift if released. Overriding the Lift controls could lead to damage to the Lift, damage to the Vehicle on the Lift, or injury (even death) to persons near the Lift.

Remain clear of the Lift as it comes down; obey the pinch point warning decals.

5. When the Lift is on the ground, release both Handles, then move all four Lift Arms to their full drive-through positions.
6. Drive the Vehicle out.

About Safety Locks

Your Lift has 14 Safety Lock positions, spaced every three inches; having multiple Safety Lock positions let you lock the Lift at the best height for what you need to do.

A Safety Lock **position** is defined as when the Lift is engaged on both of the Lift's Safety Locks at the same height on both Posts.

Important: Always make sure the both Safety Locks are engaged at the same height on both Posts. You do not want the Lift engaged on Safety Locks of two different heights or the Safety Lock on one Post engaged but the Safety Lock on the other Post not engaged.

Safety Lock positions are created by the Safety Lock Weldments, which are on the back of each Lift Head. Safety Lock Weldments hit the Safety Locks and then move past them as the Lift Heads rise.

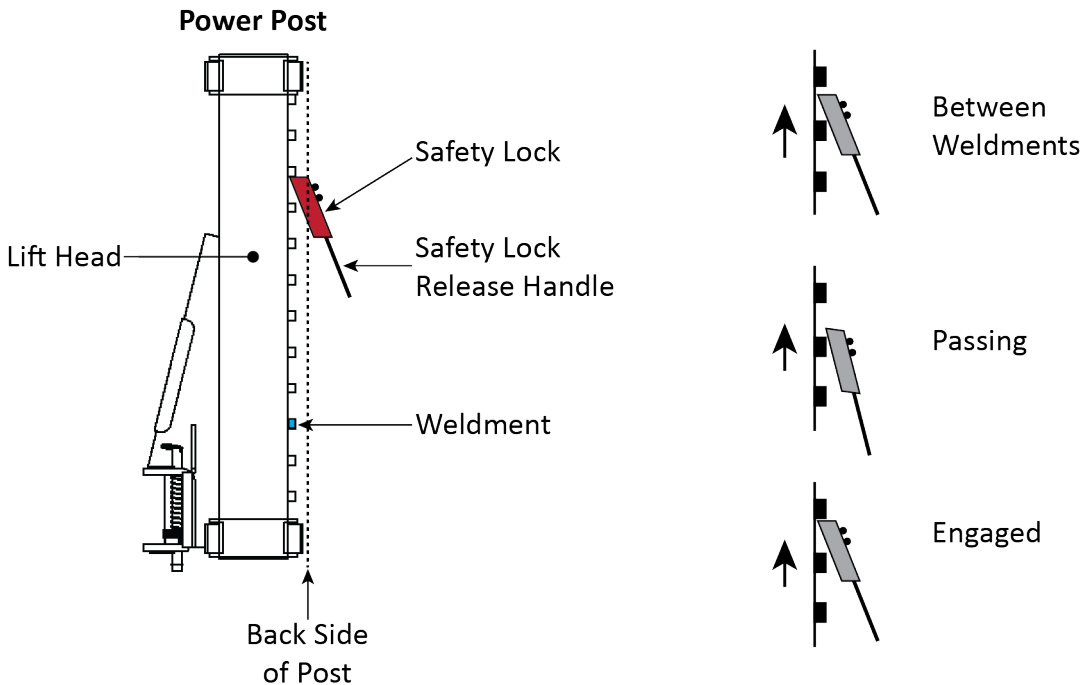

Drawing not necessarily to scale. Not all components shown. Posts not shown for clarity. Offside Safety Lock not shown.

As they move past the Safety Locks, the Weldments push the Safety Lock and the Safety Lock Release Handle down (the Safety Lock Release Handle is found on the Powerside Post only). When the Weldment is completely past the Safety Locks, the Safety Locks clank back into position between Weldments. This happens each time Safety Locks are passed, so you will generally be hearing multiple clanks as the Lift rises and lowers.

To engage the Lift on a Safety Lock position, wait until the Vehicle reaches the desired height for the work you are going to do, then listen for the clank as the Weldments pass the next Safety Lock position. When you hear the clank, release the Up Button and then hold down the Lowering Handle (on the front of the Power Unit) for a second or two to back the Weldments down onto the just-passed Safety Locks; **do not** hold down the Safety Lock Release Handle.

⚠ WARNING: Only leave the Lift either fully lowered or engaged on Safety Locks. ***If you leave the Lift raised but not engaged on Safety Locks, the Vehicle is not secure.*** It could fall, possibly damaging the Vehicle, the Lift, and injuring anyone under the Vehicle.

Maintenance

 **DANGER** Before performing any maintenance on your Lift, make sure it is completely disconnected from power. The Lift uses electrical energy; if your organization has Lockout/Tagout policies, make sure to implement them before performing any maintenance. If you come into contact with high voltage/current, you could be injured or killed.

To maintain your Lift:

- **Daily:** Keep the Lift clean. Wipe up any spills, clean any dirt.
- **Daily:** Make a visual inspection of all moving parts and check for damage or excessive wear. Replace any damaged or worn parts before using the Lift.

 **DANGER** Do not use the Lift if the cables are damaged or extremely worn. If a Vehicle is raised when you notice the damage or extreme wear, very carefully lower the Vehicle to the ground. When the Lift is on the ground, remove it from service, disconnect it from power, and make arrangements to get it fixed.

- **Daily:** Make sure Safety Locks are in good operating condition. Do not use your Lift if the Safety Locks are damaged or excessively worn.
- **Weekly:** Check all controls to make sure they are functioning normally.
- **Weekly:** Check all labels on the Lift. Replace them if they are illegible or missing.
- **Monthly:** Lubricate the Posts. We recommend using white lithium grease or similar.
- **Monthly:** Check Hydraulic Fluid levels. Refill if low.
- **Monthly:** Check cable connections, bolts, and pins for proper mounting and torque.
- **Monthly:** Make sure all pivot arm pins are properly secure.
- **Every two months:** Check all Anchor Bolts to make sure they are correctly torqued. If they are not, torque them.
- **Every three to five years or as needed.** Carefully check the Equalizing Cables every three to five years, or immediately if there are signs of damage or extreme wear. See **Wire Rope Inspection and Maintenance** for additional information.

 **WARNING:** Do not operate your Lift if you find maintenance issues; instead, remove it from service, then contact your dealer or BendPak Support via the Web at bendpak.com/support, via email at techsupport@bendpak.com, or by phone at **(800) 253-2363**.

Wire Rope Inspection and Maintenance

Your Lift's wire rope should be inspected regularly:

- Lifting cables should be replaced when there are visible signs of damage or extreme wear. **Do not use the Lift if it has damaged or worn cables.**
- Lifting cables should be maintained in a well-lubricated condition at all times.

Wire rope is fully protected when each wire strand is lubricated both internally and externally. Excessive wear shortens the life of wire rope. Use a wire-rope lubricant that penetrates to the core of the rope and provides long-term lubrication between each individual strand, such as 90-WT gear oil or ALMASOL® Wire Rope Lubricant.

To make sure that the inner layers of the rope remain well lubricated, lubrication should be carried out at intervals not exceeding three months during operation.

- All sheaves and guide rollers in contact with the moving rope should be given regular visual checks for surface wear and lubricated to make sure they run freely. This operation should be carried out at appropriate intervals generally not exceeding three months during operation.

For all sheave axles, use standard wheel bearing grease. For all sheaves and/or guide rollers, use 90-WT gear oil or a similar heavy lubricant, applied by any method including pump/spray dispensing, brush, hand, or swabbing.

- How often should you inspect?

Lifting cables should be visually inspected at least once each day when in use, as suggested by American Petroleum Institute's Recommended Practice 54 guidelines. Any lifting cables that have met the criteria for removal must be immediately replaced.

- When should you replace lifting cables due to broken wires?

Lifting cables should be removed from service when you see six randomly distributed broken wires within any one lay length, or three broken wires in one strand within one lay length.

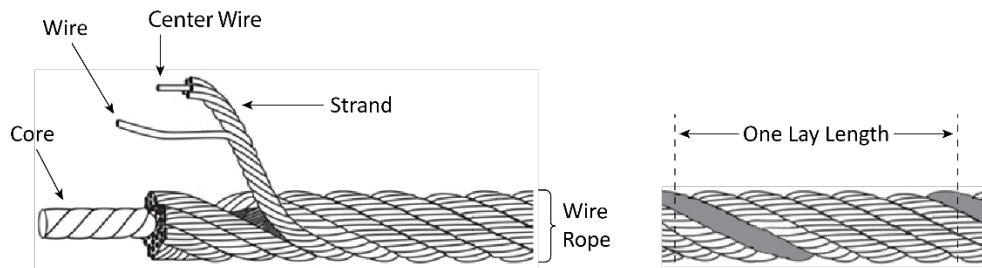

- Are there other reasons to replace your lifting cables?

Yes. Corrosion that pits the wires and/or connectors, evidence of kinking, crushing, cutting, bird-caging, or a popped core, wear that exceeds 10% of a wire's original diameter, or heat damage.

- How do you find broken wires?
 - a. Relax your rope to a stationary position and move the pick-up points off the sheaves. Clean the surface of the rope with a cloth — a wire brush, if necessary — so you can see any breaks.
 - b. Flex the rope to expose any broken wires hidden in the valleys between the strands.
 - c. Visually check for any broken wires. One way to check for crown breaks is to run a cloth along the rope to check for possible snags.
 - d. With an awl, probe between wires and strands and lift any wires that appear loose. Evidence of internal broken wires may require a more extensive rope examination.

Troubleshooting

This section describes how to troubleshoot your Lift.

Note: If your Lift is not functioning correctly, you must take it out of service until it is fixed.

Important: All repair work **must** be done by qualified personnel.

 **WARNING** The Lift uses electrical energy; if your organization has Lockout/Tagout policies, make sure to implement them before performing any Troubleshooting.

Issue	Action to Take
Lift does not raise or does not lower, once raised.	Make sure there is sufficient Hydraulic Fluid in the reservoir. Make sure there is no air in the Hydraulic System. Make sure none of the Hydraulic Lines are pinched or leaking. Make sure the Power Unit is getting power. If the Hydraulic Fluid is dirty, replace it with clean fluid. Make sure the Lift is not overloaded. Make sure the load on the Lift is balanced.
Arms move erratically or squeak when in use.	Move the arms up and down a few times to flush any residual air from the Hydraulic System.
Lift does not stay up.	Make sure to leave the Lift engaged on its Safety Locks. Check for Hydraulic Fluid leaks.
Vehicle on Lift not level.	Make sure Lift is engaged on Safety Locks at the same height. Make sure the Safety Locks in both Posts are engaged. If either condition is not met, carefully lower the Vehicle back down to the ground and raise it again.
Motor not running.	Check connection to power source; make sure it is plugged in and the appropriate voltage. Check wiring diagram on Power Unit.
Hydraulic Fluid is dirty.	Replace the dirty Hydraulic Fluid with clean, approved ATF fluids, such as Dexron III, Dexron VI, Mercon V, Mercon LV, or comparable.
Lift makes odd noises.	Lubricate hinge points using white lithium grease.

If you continue to have issues with your Lift, take the Lift out of service, then contact your dealer or BendPak Support at bendpak.com/support, via email at techsupport@bendpak.com, or by phone at **(800) 253-2363**.

Disposing of Used Hydraulic Fluid

Used Hydraulic Fluid cannot be disposed of by dropping it into the trash or dumping it into the street. It has toxic ingredients that are harmful to the environment.

Instead, you need to either recycle it or drop it off at a hazardous waste collection facility.

First, note that there is a difference between dirty and contaminated Hydraulic Fluid:

- **Dirty** means it has been used for some time and it would benefit your equipment if new fluid was used.
- **Contaminated** means it has been mixed with other fluids or other components, rendering it unsuitable for recycling. Contaminated fluid must be treated as hazardous waste.

Dirty fluid should be recycled, which is beneficial to the environment. Contaminated fluid cannot be recycled; it must be disposed of at a hazardous waste collection facility.

Rags and/or granular absorbents that have soaked up Hydraulic Fluid should be treated like hazardous waste and be disposed of at a hazardous waste collection facility.

To find an appropriate facility:

- Local automotive parts stores, auto care facilities, or automobile dealerships may accept fluid for recycling or, in some cases, for disposal. Contact them for more information.
- Cities, counties, and states often support both recycling facilities and hazardous waste collection facilities. Contact them to see if and where they have these programs.
- If you have large amounts of fluid, consider contacting a commercial waste disposal company. In all cases, the best approach is to find an appropriate facility and contact them — in advance — to ask them: what kinds of fluids they accept, what kind of containers it must be in, what hours they are open, their location, and any other information specific to their facility.

If you are unable to find an appropriate facility, the website earth911.com has resources that may be of help.

Wiring Diagrams

This section includes wiring information for the Microswitch(es).

⚠ DANGER All wiring **must** be performed by a licensed, certified Electrician. Make sure that main electrical power has been disconnected from the Lift and cannot be re-energized until all procedures are complete. If your organization has Lockout/Tagout policies, make sure to implement them after connecting the Lift to power.

Single Phase

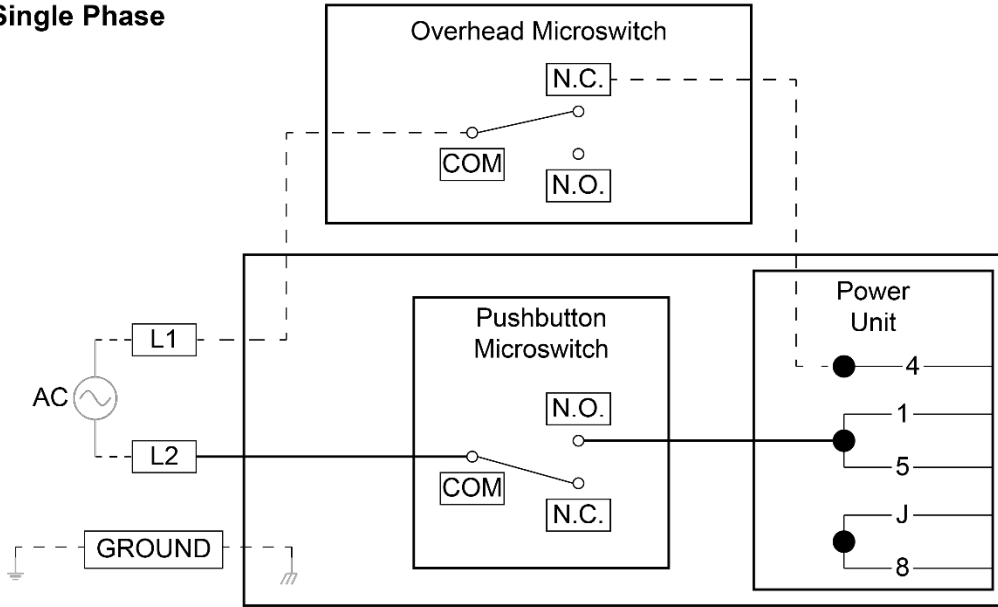

Three Phase

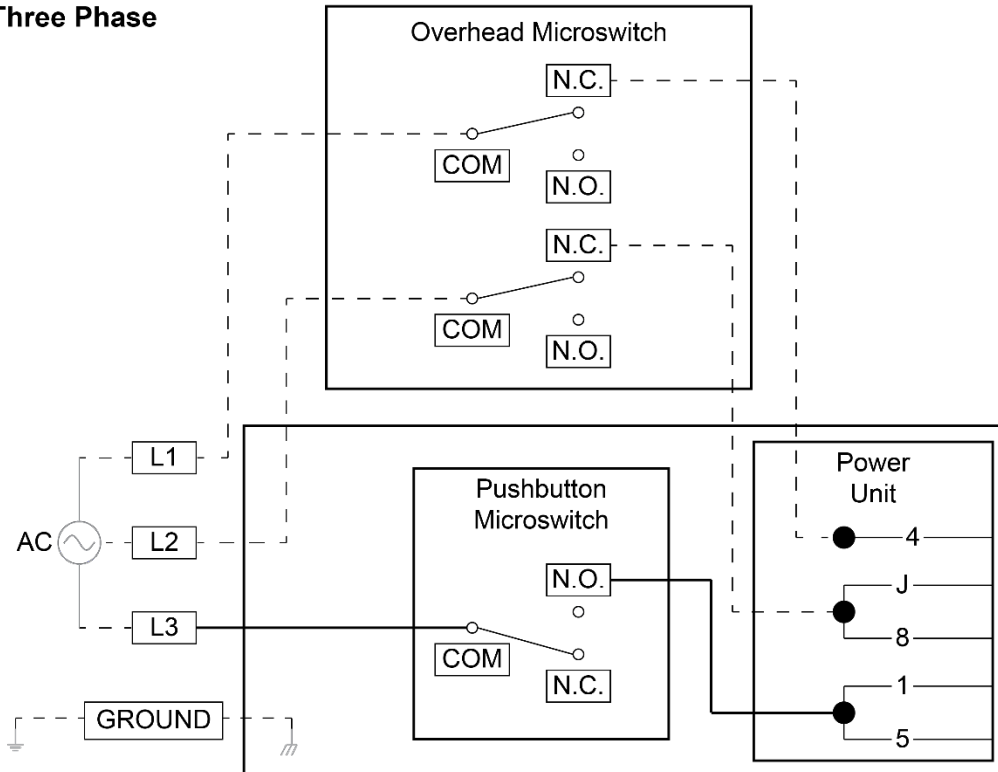

Labels



IMPORTANT
OPERATION / MAINTENANCE INSTRUCTIONS - PLEASE READ

⚠ DANGER

Long-wheelbase vehicles can damage lift and/or other vehicles. Never lift any vehicle or other object on lift with CENTER OF GRAVITY midway between adapters.

⚠ CAUTION

Never lift any vehicle in any manner with FEET (or arms) raised. Capacity of each lift arm is no greater than 1/4 of the overall lifting capacity.

⚠ WARNING
USE PROPER ADAPTERS

Do not attempt to lift trucks or other items from lift caps with adapters unless certified. Do not use lift caps with missing or damaged rubber contact pads. ALWAYS REFER to user manual for correct pads with a view of correct. Contact BendPak or your electrical dealer for product and support.

FRAME CRADLE ADAPTERS
SKU# 425776

Required for use when lifting trucks, vans or other frame vehicles that require additional stability.

SUV & VAN ADAPTERS

96 mm 63 mm 125 mm
SUVs are used for trucks, SUVs and vans that require additional lifting height.

STEEL LIFT PADS
SKU# 425776

Steel lift pads are recommended for additional stability on all vehicles. The stamped design is an alternative to cast.

POLYURETHANE TIE PADS
SKU# 425776

NEVER use lift with missing or damaged rubber contact pads. ALWAYS REFER to user manual for correct pads with a view of correct. Contact BendPak or your electrical dealer for product and support.

TO PLACE ORDER Monday - Friday
Visit www.bendpak.com 6 a.m. - 4:30 p.m. PST
or call 1-800-822-9910

⚠ WARNING
WIRE ROPE INSPECTION AND MAINTENANCE

- Lifting cables shall be inspected every 30 days. Signs of wear include signs of damage and separation. DO NOT USE LIFT WITH DEFECTIVE OR WORKING CABLES.
- Wire rope should be maintained in a well-lubricated condition at all times. Wire rope is only fully protected when each wire strand is lubricated from internally and externally. Excessive wear will shorten the life of the wire rope. The factory suggests wire rope be replaced from the end of the rope and provide adequate lubrication between each tie cable strand, in order to ensure that the outer layers of the rope remain well-lubricated, lubricator should be carried out at intervals not exceeding three (3) months during operation.
- All ropes and pulley rollers in contact with the moving wire rope should be given regular visual checks for surface wear and lubricated to make sure that the rope is free to rotate. The rotation should be carried out at appropriate intervals generally not exceeding three (3) months during operation. For all changes and/or specific repairs, the factory recommends 60-70 psi or a similar heavy lubricant applied by any method, including pump spray dispensing, brush, hand and/or soaking.

LIFT OPERATION

TO RAISE LIFT

- Read Operating and Safety Manual before using lift. Always lift vehicle according to manufacturer's recommended lift limits.
- Position vehicle between columns. Adjust spring arms so that all are in contact with the center of gravity and/or contact pads.
- Adjust lift contact pads to manufacturer's recommended lift height.
- Use lock adapters as needed. Never exceed 3" of pad height.
- Raise lift by pressing RAISE BUTTON on power unit until contact pads make contact with the underside of the vehicle.
- Push back to ensure wire rope is taut.
- Raise vehicle to desired working height. Then press power unit LOWERING HANDLE until lift carriage has not moved to lock position.
- At this time, visual contact with vehicle and surrounding area at all times while lowering lift.
- STOP IMMEDIATELY** if load shifts or becomes unlevel.
- Always ensure safety locks are engaged before any attempt is made to back or raise vehicle.
- Always ensure lift contact pads are making full contact with vehicle before any attempt is made to work on or over vehicle.

TO LOWER LIFT

- Push lift by pressing LOWER BUTTON on power unit. Ensure at least three fingers to release safety catch for the locks to clear.
- Clear safety pads to maintain pressure on SAFETY LOCK RELEASE HANDLE to lift feet travel.
- Do not touch top, sides or personnel and removed from under vehicle.
- Lower vehicle by pressing corner unit LOWERING HANDLE until lift has descended completely.
- At this time, visual contact with vehicle and surrounding area at all times while lowering lift.
- STOP IMMEDIATELY** if load shifts or becomes unlevel.
- Before lowering vehicle to the lift arms, position lift arms to provide adequate clearance.
- NEVER drive over lift arms.

REQUIRED MONTHLY MAINTENANCE

- Always contact operation manual for factory-recommended maintenance.
- Check arm nuts/bolts for proper operation.
- Check all electrical connections, both and pins to ensure proper operation.
- Check all bearing entry seals for proper operation.
- Visually inspect concrete floor. DO NOT USE LIFT if concrete floor is uneven, soft or deteriorated.
- Inspect all anchor bolts and re-embed if necessary.
- Check columns for bases, ensure pins are tight.
- Inspect all pivot pins, making sure they are properly greased.
- Check weather cable brackets - cables must have no oil, kinks, or damage. Adjust if necessary.
- Inspect all lift pads, replace if necessary.
- Lift to be engaged with steel foot on lift pad, check for proper operation.

WARNING: Do not operate lift with any person or equipment below. Do not operate lift with any person or equipment below. Do not operate lift with any person or equipment below. Do not operate lift with any person or equipment below.

⚠ DANGER

THE MAXIMUM LIFTING CAPACITY FOR THIS LIFT IS DESCRIBED BELOW

Maximum Lifting Capacity
10,000 lbs. / 4536 kg

Max. Lifting Cap. / Front of Lift Center
5000 lbs. / 2268 kg

Max. Lifting Cap. / Rear of Lift Center
5000 lbs. / 2268 kg

Exceeding the weight capacity of this lift can damage lift and/or property and may cause personal harm, injury or death to operators and/or bystanders. All vehicles MUST be positioned on lift with CENTER OF GRAVITY midway between adapters and/or centered on runways. Damage to lift due to overloading or misuse IS NOT covered under warranty.

PN 5905403

CERTIFIED AUTOMOTIVE LIFT

ALI CERTIFIED
To the provisions of ANSI/ALI ALCVT-2017
SAFETY REQUIREMENTS FOR CONSTRUCTION, TESTING AND VALIDATION

Automotive Lift Institute, Inc. | Cortland, NY 13845

MET LISTED
Conforms to ANSI/JUL 201
SAFETY STANDARD FOR GARAGE EQUIPMENT

Certification Label: Serial Number
ALXXSAMPLEXXN

⚠ ATTENTION

MAXIMUM LIFTING CAPACITY

10000 Lbs.
4536 Kg.

PN 5905403

NOTICE

If attachments, accessories, or configuration modifying components used on this lift are located in the load path and affect operation of the lift, affect the lift electrical listing, or affect intended vehicle accommodation; and if they are not certified for use on this lift, then the certification of this lift shall become null and void. Contact the participant for information pertaining to certified attachments, accessories, or configuration modifying components.

www.autolift.org ©2011 by ALI, Inc. ALI / WLSIA01

BP BendPak
PROVIDING AUTOMOTIVE SERVICE SOLUTIONS

SANTA PAULA, CA USA
WWW.BENDPAK.COM

LIFT TYPE: SURFACE MOUNT CAP: MED/HVY DTY MFG: BPK SEE DATA PLATE FOR PRODUCT DETAILS
POWER: ELECTRIC/HYDRAULIC INSTALLATION - SEE OWNERS GUIDE OR CONTACT FACTORY

SAFETY INSTRUCTIONS: IF ATTACHMENTS, ACCESSORIES OR CONFIGURATION MODIFYING COMPONENTS THAT ARE LOCATED IN THE LOAD PATH, AFFECT OPERATION OF THE LIFT, AFFECT THE LIFT ELECTRICAL LISTING OR AFFECT INTENDED VEHICLE ACCOMMODATION ARE USED ON THIS LIFT AND, IF THEY ARE NOT CERTIFIED FOR USE ON THIS LIFT, THEN THE CERTIFICATION OF THIS LIFT SHALL BECOME NULL AND VOID. CONTACT THE PARTICIPANT FOR INFORMATION PERTAINING TO CERTIFIED ATTACHMENTS, ACCESSORIES OR CONFIGURATION MODIFYING COMPONENTS.

BENDPAK LIFTS ARE SUPPLIED WITH CONCRETE FASTENERS MEETING THE CRITERIA AS PRESCRIBED BY ASTM E488 - 05(2003). LIFT BUYERS ARE RESPONSIBLE FOR ANY SPECIAL REGIONAL STRUCTURAL AND/OR SEISMIC ANCHORING REQUIREMENTS SPECIFIED BY ANY OTHER AGENCIES AND/OR CODES SUCH AS THE UNIFORM BUILDING CODE (UBC) AND/OR INTERNATIONAL BUILDING CODE (IBC).

THE MANUFACTURE, USE, SALE OR IMPORT OF THIS PRODUCT MAY BE SUBJECT TO ONE OR MORE UNITED STATES PATENTS, OR PENDING APPLICATIONS, OWNED BY BENDPAK, INC.
DO NOT REMOVE ENGINEERED BY BENDPAK INC. USA MADE IN CHINA

PLEASE READ

Internal packing oil may cause the cylinders to bleed oil during start up. This is normal. To extend cylinder and seal life, raise the lift to full height at least once every day.





F

NOTICE

Read operating and safety manuals before using lift.
©
NOTICE



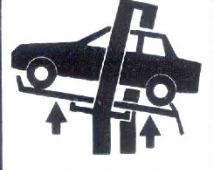

Proper maintenance and inspection is necessary for safe operation.
©
NOTICE

Do not operate a damaged lift.
©

CAUTION	CAUTION
	
Lift to be used by trained operator only.	Authorized personnel only in lift area.
©	©
CAUTION	CAUTION
	
Use vehicle manufacturer's lift points.	Always use safety stands when removing or installing heavy components.
©	©
CAUTION	CAUTION
	
Use height extenders when necessary to ensure good contact.	Auxiliary adapters may reduce load capacity.
©	©

WARNING	WARNING
	
Clear area if vehicle is in danger of falling.	Position vehicle with center of gravity midway between adapters.
©	©
WARNING	WARNING
	
Remain clear of lift when raising or lowering vehicle.	Avoid excessive rocking of vehicle while on lift.
©	©
WARNING	WARNING
	
Do not override self-closing lift controls.	Keep feet clear of lift while lowering.
©	©

K

BP BendPak		Santa Paula, CA USA www.bendpak.com
MODEL NUMBER		
DESCRIPTION		
LIFT CAPACITY		DATE OF MFG.
VOLTAGE	SERIAL NUMBER	
<input type="checkbox"/> 110-240VAC, 50-60 Hz, 1 Ph <input type="checkbox"/> 208-240VAC, 50-60 Hz, 1 Ph <input type="checkbox"/> 380-415VAC, 50-60 Hz, 3 Ph <input type="checkbox"/> 208-440VAC, 50-60 Hz, 3 Ph	 <small>51528671</small>	
	UPC  <small>90392-3372</small>	
 DANGER! Disconnect Power Before Servicing		
WARRANTY VOID IF DATA PLATE IS REMOVED		  PN 5905950

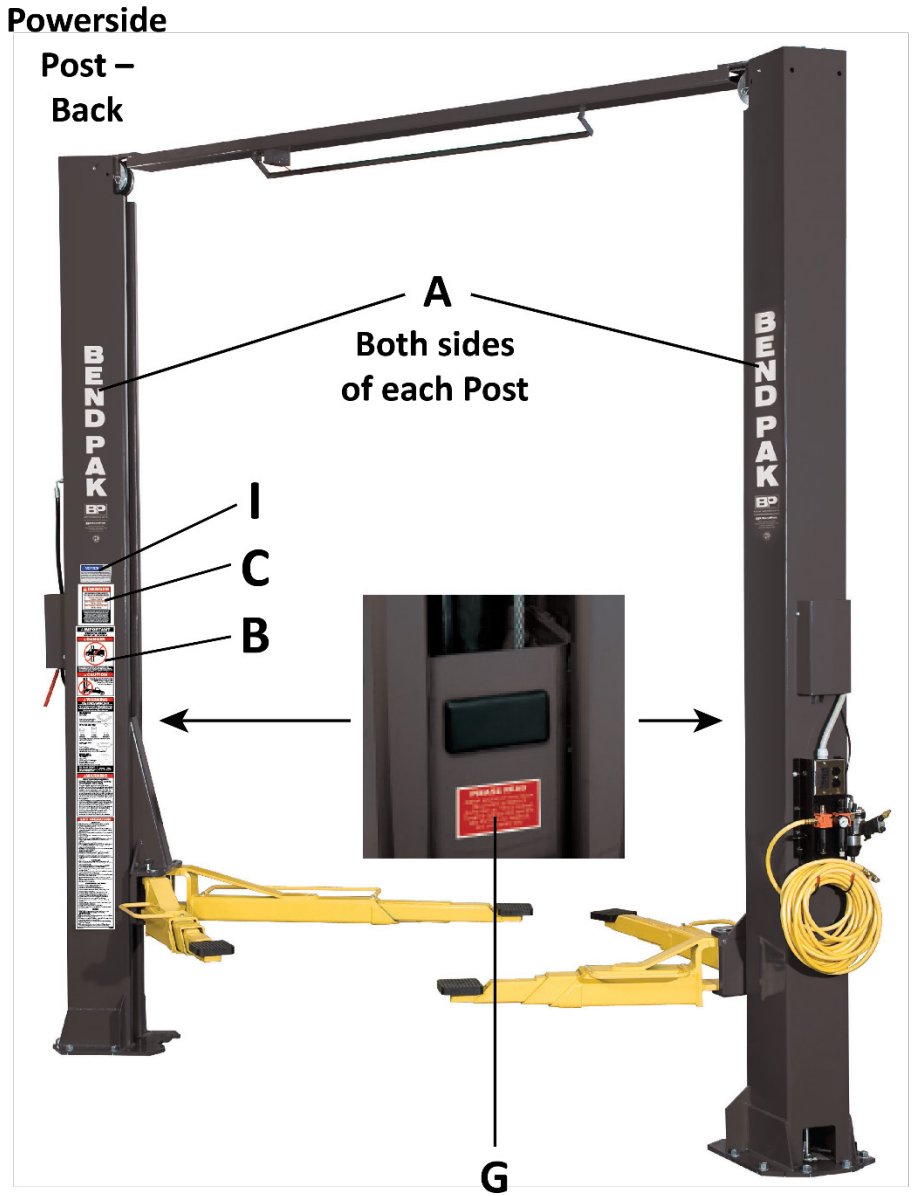
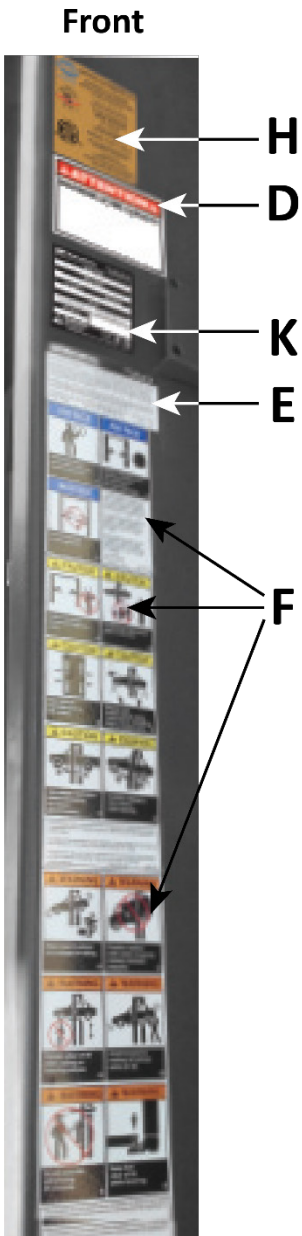

Parts Drawings

A complete set of **Parts Drawings for XPR-10 Series Lifts** is available on the BendPak website.

ITEM NO.	PART NUMBER	DESCRIPTION	QTY	REV
1	5505001	GP-7/XPR SERIES SAFETY CLEVIS PIN	2	B
2	5715196	XPR POLYETHYLENE COVER BLOCK 105 x 80	2	D
3	5535022	NUT 9/16"-18 JIN	1	-
4	5550113	FIG ELB -04 NPT LX-04 JIC	2	-
5	5550183	FIG ELB -06 JIC -04L ORB	1	-
6	5550003	FIG TEE -04 JIC -04 JIC -06 JIC	1	-
7	5505390	MODEL #211 HAIR PIN/LARGE	2	-
8	5530261	PHPS M6 x 1 x 1.0	4	-
9	5545347	WASHER, M12 FLAT WASHER	2	-
10	5535354	NUT M12 x 1.75	10	-
11	5535001	NUT M8 x 1.25 NL	4	-
12	5530010	HRB M8 x 1.25 x 25	4	-
13	5545200	WASHER M10 x Ø18 SI	4	-
14	5535928	NUT M10 x 1.5	4	-
15	5530760	HRB M10 x 1.5 x 38	4	-
16	5545201	WASHER, M12 SPRING LOCK	8	-
17	5545027	WASHER M12 x Ø37 x 3mm	16	-
18	5530076	HRB M12 x 1.75 x 35mm	8	-
19	5540075	2.5 WIRE DIA. Ø20.5 x 7.5 LG	4	A
20	5530760	SMS M4 x 0.7 x 6	2	-
21	5545535	C WASHER SHIM FOR LIFTS	20	-
22	5535013	NUT M10 x 1.5 NL	4	-
23	5545341	WASHER M10 x Ø20 FLAT	4	-
24	5505031	ROTOR CLIP 12mm SS	1	-
25	5530115	BHS 6-32 x 1.25	2	-
26	5535190	HN 6-32	2	-
27	5520140	ROMEX CONNECTOR 3/8 #6623	2	-



1645 LEMONWOOD DR.
SANTA PAULA, CA 93060

TITLE: XPR CLEARFLOOR
EXTENDED PARTS BAG

SIZE DWG. NO. 5174218
REV L

SCALE: 1:18
SHEET 1 OF 1

DO NOT SCALE DRAWING

DIMENSIONS ARE IN MM

THIRD ANGLE PROJECTION



PROPRIETARY AND CONFIDENTIAL
THIS DRAWING IS THE PROPERTY OF BENDPAK INC. ANY
REPRODUCTION IN PART OR AS A WHOLE WITHOUT
PERMISSION IS STRICTLY PROHIBITED.

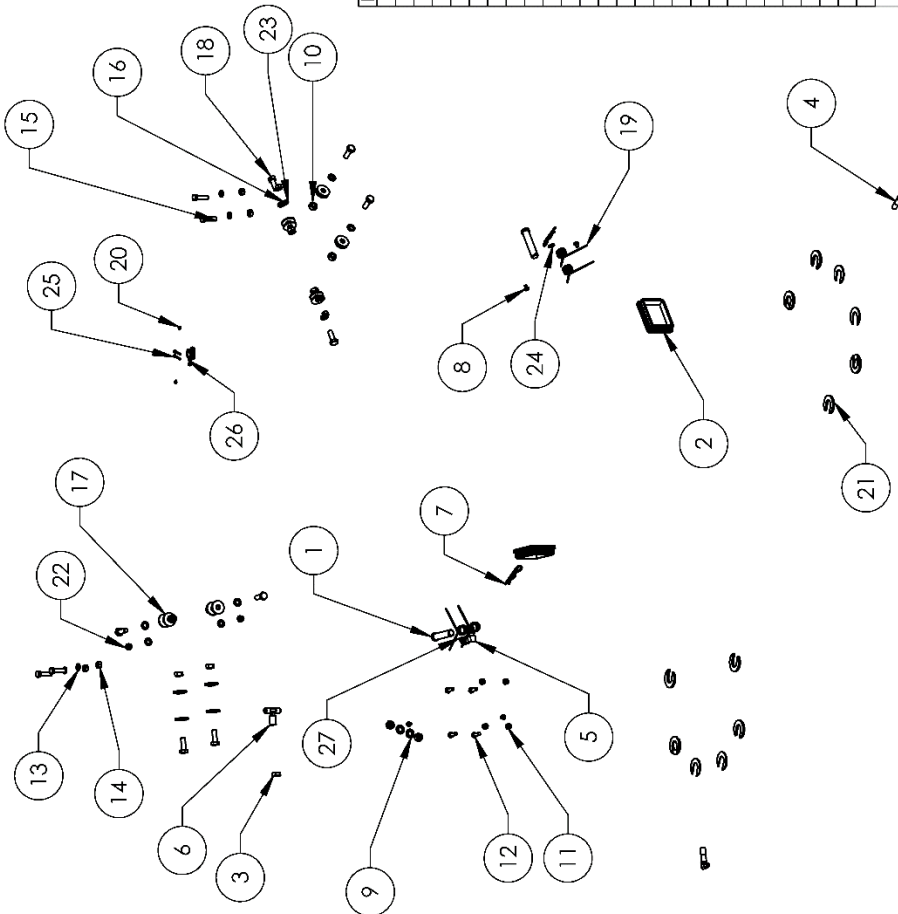



ITEM NO	PART NUMBER	DESCRIPTION	QTY	REV
1	5174218	XPR CLEARFLOOR EXTENDED PARTS BAG	1	L
2	5505116	XPR 9/10 LIFT HEAD PIN WELDMENT	4	D
3	5595837	XPR-10A EXTENDED CABLE ASSY Ø10 x 11219mm DBST	1	C
4	5595923	XPR-10A EXTENDED CABLE ASSY Ø10 x 11335mm DBST	1	C
5	5570065	XPR-10A HYDRAULIC HOSE EXTENSION ASSY Ø6.35 x 203mm DS	1	C
6	5570832	XPR CLEARFLOOR HYDRAULIC HOSE ASSY Ø6.35 x 2299mm SB	1	E
7	5570017	XPR HYDRAULIC HOSE ASSY Ø10 x 1219mm SB	1	C
8	5595104	XPR-10/10A EXTENDED Ø2.4 x 8839 SAFETY CABLE	1	E
9	5570059	XPR-10A EXTENDED HYDRAULIC HOSE ASSY Ø6.35 x 9308 SB	1	B
10	5210196	XPR POWER SIDE INCLINED SAFETY ASSEMBLY	1	A
11	5210010	XPR OFF SIDE SAFETY WELDMENT	1	F
12	5715003	POWER UNIT VIBRATION DAMPENER	1	B
13	5215704	ROUND ADJUSTABLE LIFT PAD ASSEMBLY	4	H
14	5701631	XPR-10 POST ASSEMBLY LIFT HEAD FOOT GUARD	2	A
15	5736604	TWO POST LIGHT DUTY BOLT ON ARM RESTRAINT GEAR	4	E
16	5716173	GP/XPR POWER SIDE PLASTIC SAFETY COVER	1	B
17	5716174	GP/XPR OFF SIDE PLASTIC SAFETY COVER	1	B
18	5746192	ARM ADAPTER, MEDIUM	4	D
19	5545342	WASHER M18 FLAT	2	--
20	5535358	NUT M18 x 2.5 NL	2	--
21	5540281	C RING Ø38mm OD 5103-150	4	--
22	5746167	DOUBLE THREADED ROD M10 x 1.5 x 27.5	2	B
23	5716634	XPR MICROSWITCH COVER, PLASTIC	1	A
24	5550095	FIG NPL -04 JIC x -04 JIC	1	--
25	5530337	AB 3/4" x 6.3"	12	--
26	5900951	XPR-10S SERIES INSTALLATION MANUAL	1	--
27	5525150	SPDT MICRO SWITCH:25A@125VAC	1	--
28	5525112	MICRO SWITCH COVER-5PA2	1	--
29	5520116	14-4 SJO UL 62 CABLE 300vdc	427.5mm*	--

DO NOT SCALE DRAWING

BendPak
 1645 LEMONWOOD DR.
 SANTA PAULA, CA 93060

NAME	DATE
DRAWN TM	10/12/2018
CHECKED CA	04/19/2019

TITLE: XPR-10AS EXTENDED PARTS BOX
 THIRD ANGLE PROJECTION

SIZE DWG. NO.	REV
A	B
5250087	
SCALE: 1:30	SHEET 1 OF 2

PROPRIETARY AND CONFIDENTIAL
 THE INFORMATION CONTAINED IN THIS DRAWING IS THE PROPERTY OF BENDPAK INC. AND IS TO BE USED ONLY FOR THE PROJECT AND FOR WHICH IT WAS PREPARED. PERMISSION OF BENDPAK INC. IS REQUIRED FOR ANY OTHER USE.

DIMENSIONS ARE IN MM

BendPak
 1645 LEMONWOOD DR.
 SANTA PAULA, CA 93060

TITLE: XPR-10AS EXTENDED
 PARTS BOX

SIZE DWG. NO.	REV
A 5250087	B

SCALE: 1:25 SHEET 2 OF 2

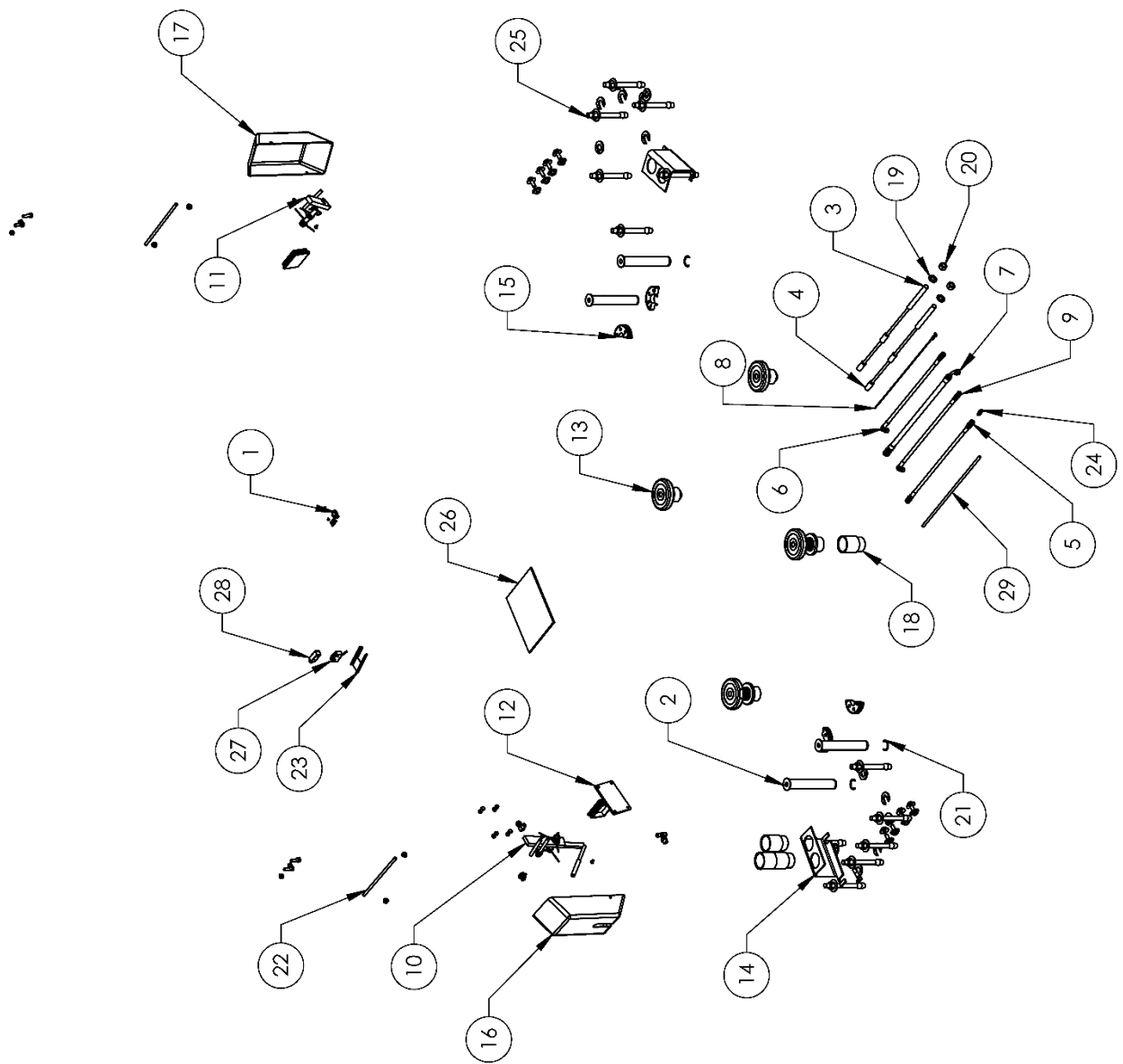



ITEM NO	PART NUMBER	DESCRIPTION	QTY	REV
1	5174518	XPR CLEARFLOOR PARTS BAG	1	L
2	5505116	XPR-9/10 LIFT HEAD PIN WELDMENT	4	D
3	5595086	XPR-10AXIS CABLE ASSEMBLY Ø10 x 10456mm DBST	1	C
4	5595087	XPR-10AXIS CABLE ASSEMBLY Ø10 x 10572mm DBST	1	C
5	5570075	XPR-10XLS/AXLS CLEARFLOOR HYDRAULIC HOSE ASSY Ø6.35 x 2451mm SB	1	C
6	5570076	XPR-10XLS/AXLS HYDRAULIC HOSE ASSY Ø10 x 1371mm SB	1	C
7	5595100	XPR-10XLS/AXLS Ø2.4 x 8077 SAFETY CABLE	1	B
8	5570077	XPR-10AXIS HYDRAULIC HOSE ASSY Ø6.35 x 8547 SB	1	B
9	5570065	XPR-10A HYDRAULIC HOSE EXTENSION ASSY Ø6.35 x 203mm DS	1	C
10	5210196	XPR POWER SIDE INCLINED SAFETY ASSEMBLY	1	A
11	5210010	XPR OFF SIDE SAFETY WELDMENT	1	F
12	5715003	POWER UNIT VIBRATION DAMPENER	1	B
13	5215704	ROUND ADJUSTABLE LIFT PAD ASSEMBLY	4	H
14	5701631	XPR-10 POST ASSEMBLY LIFT HEAD FOOT GUARD	2	A
15	5736604	TWO POST LIGHT DUTY BOLT ON ARM RESIRAINIT GEAR	4	E
16	5716173	GP/XPR POWER SIDE PLASTIC SAFETY COVER	1	B
17	5716174	GP/XPR OFF SIDE PLASTIC SAFETY COVER	1	B
18	5746192	ARM ADAPTER, MEDIUM	4	D
19	5545342	WASHER M18 FLAT	2	-
20	5535358	NUT M18 x 2.5 NL	2	-
21	5540281	C RING Ø38mm OD 5103-150	4	-
22	5746167	DOUBLE THREADED ROD M10 x 1.5 x 275	2	B
23	5716634	XPR MICROSWITCH COVER, PLASTIC	1	A
24	5550095	FTG NPL-04 JIC x -04 JIC	1	-
25	5530337	AB 3/4" x 6.3"	12	-
26	5525150	SPDT MICRO SWITCH 25A@125VAC	1	-
27	5525112	MICRO SWITCH COVER-5PA2	1	-
28	5520116	14-4 SJO UL 62 CABLE 300vdc	3940mm*	-
29	5900951	XPR-10S SERIES INSTALLATION MANUAL	1	-

DO NOT SCALE DRAWING

DRAWN	NAME	DATE
CHECKED		

THIRD ANGLE PROJECTION

TITLE: XPR-10AXIS PARTS BOX

BP BendPak.
1645 LEMONWOOD DR.
SANTA PAULA, CA 93060

SIZE DWG. NO. A 5250083

SCALE: 1:35

REV B

SHEET 1 OF 2

NO WARRANTIES AND/OR CONFIDENTIALITY. THIS IS THE PROPERTY OF BENDPAK INC. ANY REPRODUCTION OR TRANSMISSION OF THIS DRAWING WITHOUT THE WRITTEN PERMISSION OF BENDPAK INC. IS PROHIBITED.

	
1645 LEXINGTON DR. SANTA PAULA, CA 93060	
TITLE: XPR-10AXLS PARTS BOX	
SIZE DWG. NO.	REV
A 5250083	B
SCALE: 1:25 SHEET 2 OF 2	

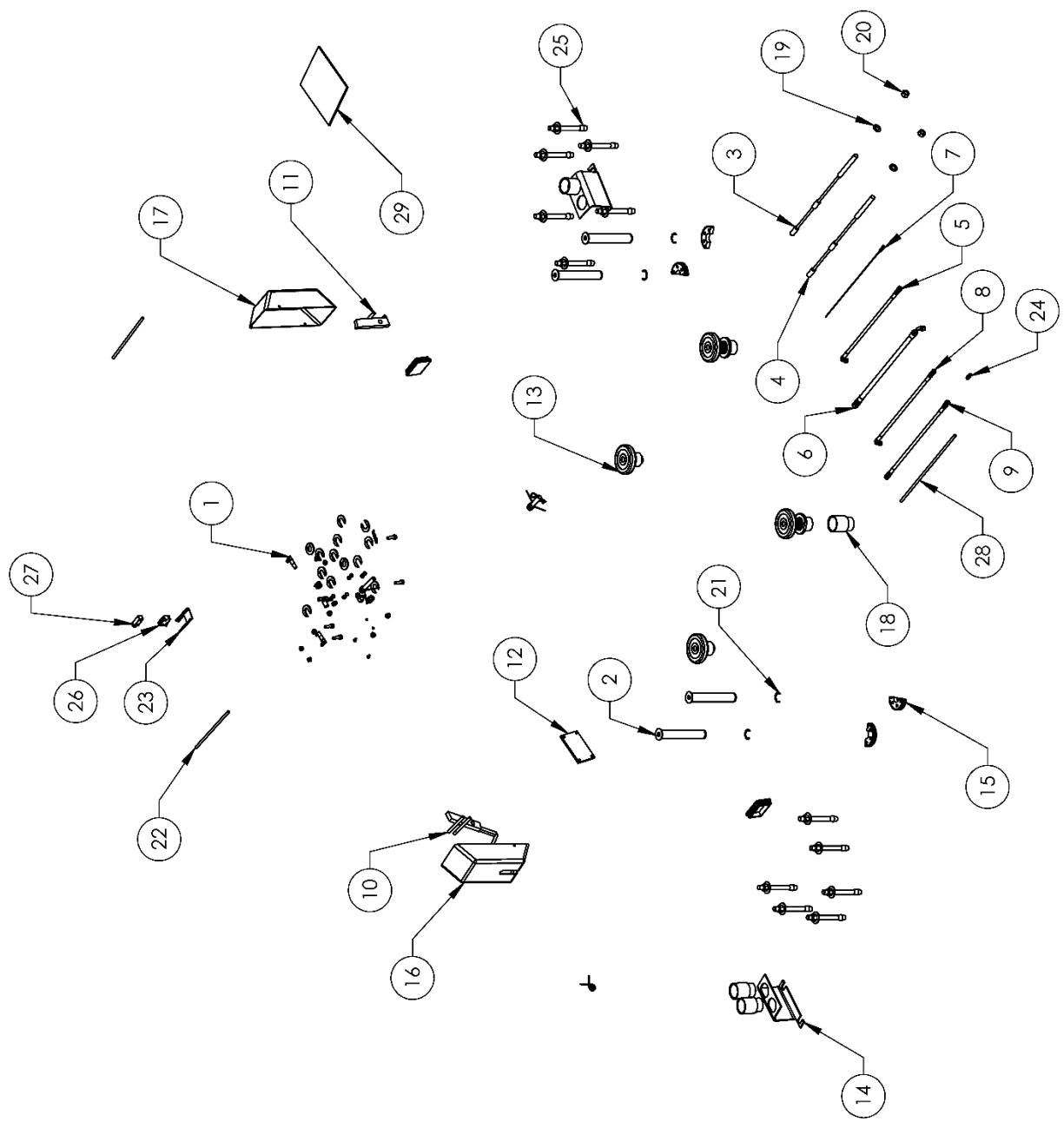



ITEM NO	PART NUMBER	DESCRIPTION	QTY	REV
1	5174218	XPR CLEARFLOOR EXTENDED PARTS BAG	1	L
2	5505116	XPR-9/10 LIFT HEAD PIN WELDMENT	4	D
3	5595368	XPR-10 EXTENDED CABLE ASSY Ø10 x 11296mm DBST	2	B
4	5570832	XPR CLEARFLOOR HYDRAULIC HOSE ASSY Ø6.35 x 2299mm SB	1	E
5	5570017	XPR HYDRAULIC HOSE ASSY Ø10 x 1219mm SB	1	C
6	5595104	XPR-10/10A EXTENDED Ø2.4 X 8839 SAFETY CABLE	1	E
7	5570005	XPR-10 EXTENDED HYDRAULIC HOSE ASSY Ø6.35 x 9233 SB	1	E
8	5210196	XPR POWER SIDE INCLINED SAFETY ASSEMBLY	1	A
9	5210010	XPR OFF SIDE SAFETY WELDMENT	1	F
10	5715003	POWER UNIT VIBRATION DAMPENER	1	B
11	5215704	ROUND ADJUSTABLE LIFT PAD ASSEMBLY	4	H
12	5701631	XPR-10 POST ASSEMBLY LIFT HEAD FOOT GUARD	2	A
13	5736604	TWO POST LIGHT DUTY BOLT ON ARM RESTRAINT GEAR	2	E
14	5716173	GP/XPR POWER SIDE PLASTIC SAFETY COVER	1	B
15	5716174	GP/XPR OFF SIDE PLASTIC SAFETY COVER	1	B
16	5746192	ARM ADAPTER, MEDIUM	4	D
17	5545342	WASHER M18 FLAT	2	-
18	5535358	NUT M18 X 2.5 NL	2	-
19	5540281	C RING Ø38mm OD 5103-150	4	-
20	5746167	DOUBLE THREADED ROD M10 X 1.5 X 275	2	B
21	5525150	SPDT MICRO SWITCH 25A@125VAC	1	-
22	5525112	MICRO SWITCH COVER-5PA2	1	-
23	5520116	14-4 SJO UL 62 CABLE 300Vgac	4275mm*	-
24	5716634	XPR MICROSWITCH COVER, PLASTIC	1	A
25	5570176	MDS-6K, XPR-9D/10 HYDRAULIC HOSE ASSY Ø6.35 x 330mm DS	1	E
26	5550095	FIG NPL -04 JIC x -04 JIC	1	-
27	5530337	AB 3/4" x 6.3"	12	-
28	5900951	XPR-10S SERIES INSTALLATION MANUAL	1	-

DO NOT SCALE DRAWING

DRAWN	NAME	DATE
CHECKED		

BP **BondPak**
 1645 LEMONWOOD DR.
 SANTA PAULA, CA 93060

TITLE: XPR-10S EXTENDED PARTS BOX

THIRD ANGLE PROJECTION

SIZE DWG. NO. A 5250089 REV B

SCALE: 1:30 SHEET 1 OF 2

PROPRIETARY AND CONFIDENTIAL
 THE INFORMATION CONTAINED HEREIN IS THE SOLE PROPERTY OF BONDPAK INC. ANY REPRODUCTION OR TRANSMISSION WITHOUT THE WRITTEN PERMISSION OF BONDPAK INC. IS PROHIBITED.

DIMENSIONS ARE IN MM



BendPak 1645 LEMONWOOD DR. SANTA PAULA, CA 93060	
TITLE: XPR-10S EXTENDED PARTS BOX	
SIZE DWG. NO. A 5250089	REV B
SCALE: 1:25 SHEET 2 OF 2	



1645 LEVONWOOD DR. SANTA PAULA, CA 93060	
TITLE:	XPR-10S EXTENDED PARTS BOX
SIZE DWG. NO.	A 5250089
REV	B
SCALE: 1:25	
SHEET 2 OF 2	



ITEM NO	PART NUMBER	DESCRIPTION	QTY	REV
1	5174218	XPR CLEARFLOOR EXTENDED PARTS BAG	1	L
2	5505116	XPR-9/10 LIFT HEAD PIN WELDMENT	4	D
3	5595554	XPR-10XLS EXTENDED CABLE ASSY Ø10 x 11752mm DBST	2	A
4	5570075	XPR-10XLS/AXLS CLEARFLOOR HYDRAULIC HOSE ASSY Ø6.35 x 2451mm SB	1	C
5	5570076	XPR-10XLS/AXLS HYDRAULIC HOSE ASSY Ø10 x 1371mm SB	1	C
6	5595553	XPR-10XLS/10AXLS EXTENDED Ø2.4 x 9296mm SAFETY CABLE	1	A
7	5570096	XPR-10XLS EXTENDED HYDRAULIC HOSE ASSY Ø6.35 x 9691mm SB	1	A
8	5210196	XPR POWER SIDE INCLINED SAFETY ASSEMBLY	1	A
9	5210010	XPR OFF SIDE SAFETY WELDMENT	1	F
10	5715003	POWER UNIT VIBRATION DAMPENER	1	B
11	5215704	ROUND ADJUSTABLE LIFT PAD ASSEMBLY	4	H
12	5701631	XPR-10 POST ASSEMBLY LIFT HEAD FOOT GUARD	2	A
13	5736604	TWO POST LIGHT DUTY BOLT ON ARM RESTRAINT GEAR	4	E
14	5716173	GP/XPR POWER SIDE PLASTIC SAFETY COVER	1	B
15	5716174	GP/XPR OFF SIDE PLASTIC SAFETY COVER	1	B
16	5746192	ARM ADAPTER, MEDIUM	4	D
17	5545342	WASHER M18 FLAT	2	-
18	5535358	NUT M18 x 2.5 NL	2	-
19	5540281	C RING Ø38mm OD 5103-150	4	-
20	5746167	DOUBLE THREADED ROD M10 x 1.5 x 27.5	2	B
21	5525150	SPDT MICRO SWITCH/25A@125VAC	1	-
22	5525112	MICRO SWITCH COVER-5PA2	1	-
23	5520116	14-4 SJO UL 62 CABLE 300VAC	4550mm*	-
24	5716634	XPR MICROSWITCH COVER, PLASTIC	1	A
25	5570176	MDS-6K, XPR-9D/10 HYDRAULIC HOSE ASSY Ø6.35 x 330mm DS	1	E
26	5550095	FTG NPL-04 JIC X-04 JIC	1	-
27	5530337	AB 3/4" x 6.3"	12	-
28	5900951	XPR-10S SERIES INSTALLATION MANUAL	1	-

DO NOT SCALE DRAWING

NAME	DATE
DRAWN	10/15/2018
CHECKED	04/19/2019

EP BendPak.
1645 LEMONWOOD DR.
SANTA PAULA, CA 93060

TITLE: XPR-10XLS EXTENDED PARTS BOX

THIRD ANGLE PROJECTION

SIZE DWG. NO. **A** 5250252

REV **B**

SCALE: 1:30 SHEET 1 OF 2

PROPRIETARY AND CONFIDENTIAL
THE INFORMATION CONTAINED IN THIS DRAWING IS THE PROPERTY OF BENDPAK, INC. AND IS TO BE USED ONLY FOR THE PROJECT AND QUANTITY SPECIFIED HEREIN. REPRODUCTION IN ANY MANNER WITHOUT THE WRITTEN PERMISSION OF BENDPAK, INC. IS PROHIBITED.

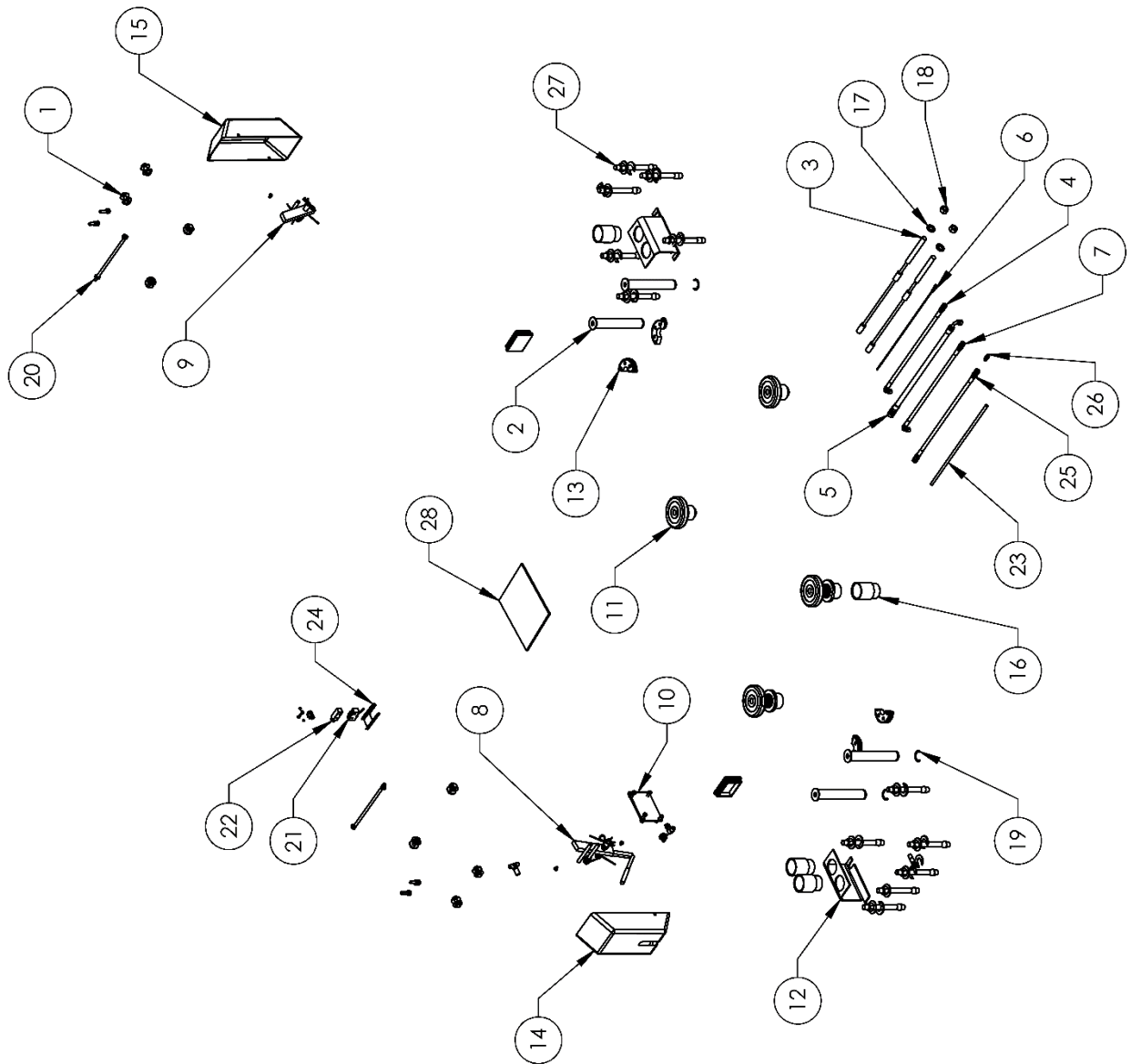

BP BendPak. 1645 LEMONWOOD DR. SANTA PAULA, CA 93060	
TITLE: XPR-10XLS EXTENDED PARTS BOX	
SIZE DWG. NO.	REV
A 5250252	B
SCALE: 1:25	
SHEET 2 OF 2	

A complete set of [Parts Drawings for XPR-10 Series Lifts](#) is available on the BendPak website.

Automotive Lift Institute (ALI) Store

You probably checked the [ALI's Directory of Certified Lifts](http://www.autolift.org/ali-directory-of-certified-lifts/) (www.autolift.org/ali-directory-of-certified-lifts/) before making your most recent Lift purchase, but did you know the **ALI Store** (www.autolift.org/ali-store/) offers a wide variety of professional, easy-to-use, and reasonably priced training and safety materials that will make your garage a safer place to work?

The ALI Store is your trusted source for workplace safety!

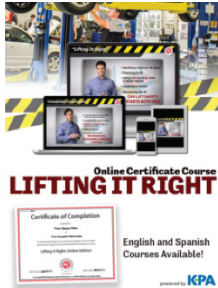

Lifting It Right Online Certificate Course. Make *sure* you and your people are lifting vehicles the right way.

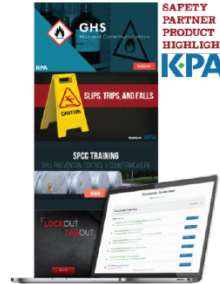

KPA Online Training Subscription. Get all of your people up to speed on automotive industry topics.

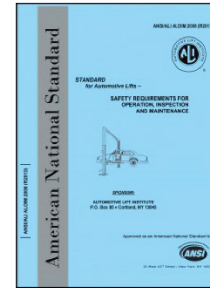

ANSI/ALI ALOIM Standard for Automotive Lifts. Safety Requirements for Operation, Inspection, and Maintenance.

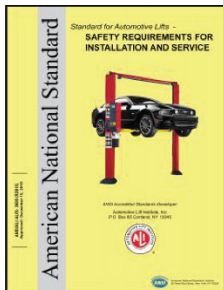

ANSI/ALI ALIS Standard. Safety Requirements for Installation and Service.

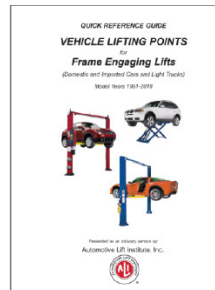

Guide to Hitting Vehicle Lifting Points for Frame-Engaging Lifts. Don't eyeball your lifting points, *know* where they are.



Lift Operator Safety Materials. Five safety documents in a single package.

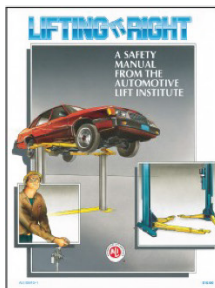

Lifting It Right. A hardcopy version of the *Lifting It Right* safety manual from the Automotive Lift Institute.



Uniform Warning Labels and Placards for 2-Posts. Labels in Mandarin, French Canadian, and Spanish are also available.



Safety Tips Card. Reminds your people of 13 key safety tips to follow daily.

Visit today and get the training and materials you need to work safely:
www.autolift.org/ali-store/.

Maintenance Log



1645 Lemonwood Drive
Santa Paula, CA 93060 USA