

BendPak®

The Benchmark of Quality

PRODUCT CATALOG



Vehicle Lifts

Parking Solutions

Shop Equipment

Wheel Service

Evaporative Coolers



R Ranger® AUTOSTACKER™ MAXJAX™

COOL BOSS™ QUICKJACK™ JACKPAK®



BENDPAK
AMERICA'S FAVORITE SINCE 1965
CAR LIFT COMPANY
HEAVY METAL



Apparel Now Available!
Go to BendPak.com/Apparel

Table of Contents

4-5	2-Post Clear Floor Lifts
6	2-Post Medium / Heavy Floor Plate Lifts
7	EV Battery Scissor Lift
8-9	2-Post Heavy-Duty Clearfloor Lifts
12	Dannmar 2-Post & 4-Post Lifts
13	GrandPrix Series Light-Duty/Medium-Duty Vehicle Lifts
14	4-Post Light-Duty
16-17	4-Post Medium-Duty
18	4-Post Options / Accessories
19	LiteStix Rechargeable Work Light
20-21	4-Post Heavy-Duty Lifts
22	Alignment Lifts
23	Rolling Bridge Jacks
25	Portable Column Lift
26-27	Scissor Lifts
28-29	MaxJax Portable 2-Post Lifts
30-31	QuickJack Portable Lift
32-33	Parking & Storage Lifts
34-35	Multi-Platform Parking Lift
36-37	JackPak Portable Jump Starter
38-39	Pipe Benders / Air Compressors
40-41	Tire Changers
42-43	Wheel Balancers
44-45	Brake Lathes / Power Units
46-47	Floor Jacks / Transmission Jacks
48-49	Jack Stands / Motorcycle Lifts
50-51	Carts & Dollies / Shop Presses / Work Benches / Hose Reel
52-53	Oil Drains / Oil Filter Crushers / Spray Wash Cabinets
54	Manual Wheel Service / Rolling Work Seat
55	Engine Support / Shop Crane / Inflation Cage / A/C Machine
56-57	ErgoChair
58-59	CoolBoss Evaporative Air Coolers
60-61	CoolBoss HVLS Industrial Ceiling Fans / Coolee Portable Air Coolers
62-63	Manufacturing Superiority

BendPak®

GENERAL DISCLAIMER

BENDPAK warrants to the original purchaser only that all products shown in this catalog conform to BENDPAK published specifications and are free from defects in material or workmanship. In no event will BENDPAK be liable to you or to anyone else for any decision made or action taken by you or anyone else in reliance on information obtained from this catalog. BENDPAK has exclusive title and ownership rights, including all intellectual property right, throughout the world in all material and content contained on these pages. Materials, design, specifications, images and other content within this catalog are subject to change. BENDPAK does not take responsibility for improper use or any results thereof. BENDPAK products are provided and sold as is without any express or implied warranties including warranties of merchantability or fitness for particular purpose. In no event will BENDPAK be liable for any special, incidental, or consequential damages based on breach of warranty, breach of contract, negligence, strict tort, or any other legal theory. Damages that BENDPAK will not be responsible for include but are not limited to: loss of profits; loss of savings or revenue; loss of use of the product or any associated equipment; cost of capital; cost of any substitute equipment, facilities, or services; downtime; the claims of third parties, including customers; and injury to property. This limitation does not apply to damages caused by breach of the warranty of title and against infringements or to claims for personal injury. Unless modified in a writing signed by both parties, it is understood that BENDPAK published warranties are to be the complete and exclusive agreement between the parties. For complete and full warranty details contact BENDPAK at 1-800-253-2363 or visit www.bendpak.com.

Equipment models shown in this catalog may be available in different voltages upon request.



2-Post Clearfloor Lifts

10AP SERIES™
10,000 lbs. CAPACITY



10AP

This is our standard model that features 73" of lifting height and an overhead beam height of just 145" for shops with lower ceiling clearances.

OVERALL WIDTH:
 135 in. / 3,431 mm (Narrow)
 145 in. / 3,683 mm (Wide)

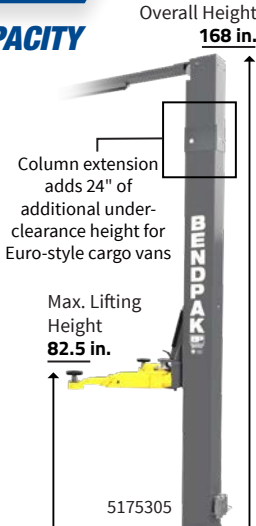

10AP-168

This model features an upper crossbar that's positioned two feet higher to accommodate high roof cargo vans. Features 73" of lifting height and an overhead beam height of 168".

OVERALL WIDTH:
 135 in. / 3,431 mm (Narrow)
 145 in. / 3,683 mm (Wide)

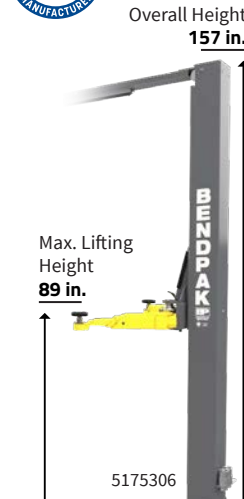

10APX

Taller technicians are sometimes at a disadvantage while working under a standard-rise lift. This high-rise model features 79.5" of lifting height and an overhead beam height of 157".

OVERALL WIDTH:
 135 in. / 3,431 mm (Narrow)
 145 in. / 3,683 mm (Wide)

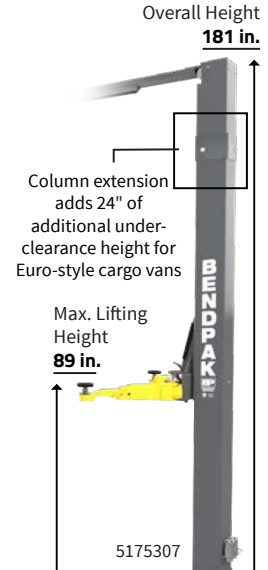

10APX-181

Like our 10APX, this high-rise model also features 79.5" of lifting height, but it comes with an overhead beam height of 181" to accommodate high-roof cargo vans.

OVERALL WIDTH:
 135 in. / 3,431 mm (Narrow)
 145 in. / 3,683 mm (Wide)

OPTIONAL ACCESSORIES



5" Tall Adapter

(Set of 4)
 SKU 5215759



2.5" Medium Adapter

(Set of 4)
 SKU 5215758



2.25" Low Adapter

(Set of 4)
 SKU 5215757



Steel Lift Pads

(Set of 4)
 SKU 5215763



Frame Cradle Pads

(Set of 4)
 SKU 5215761



Replacement Urethane Pads

(Set of 4)
 SKU 5700227



Wide Frame Cradle Pads

(Pair)
 SKU 5215848



Air Electric Work Station

(WSA-100)
 SKU 5210438

Variability in Specifications and Features: All product specifications and features listed in this catalog are for reference only. For a more accurate and comprehensive listing of product specifications and features, visit www.bendpak.com. The contents of this catalog are subject to change.

SERIES FEATURES:

- Clear-floor convenience
- Bi-Metric™ swing arms
- Low-Pro™ swing-arms
- Automatic arm restraints
- Configurable wide or narrow installation
- Single-piece columns
- Maintenance free load bearings
- Dual Direct-Drive technology
- Single-point safety release
- Dual-Synchro equalization system
- HVLP hydraulic system
- Industrial-grade hydraulic cylinders
- Super-tall lift carriages
- Varying height stackable adapters
- Triple-telescoping arms
- 14-piece standard adapter set (not incl.)
- Drop-end arms provide a lower pad height
- Oversized carriages for superior strength and durability

10APX Two-Post Lift #5175306



Durable powder coat finish

Expandable top beam

Padded overhead safety shutoff bar

Oversized cable sheave diameter reduces cable fatigue

- Heavy-duty 1/2" aircraft quality equalizer cables
- Safety locks every 3"

ASARS
360° AUTOMATIC SWING ARM RESTRAINT SYSTEM



Exclusive Bi-Metric™ arm design

UHMW polyethylene bearing system

Double-telescoping screw pads

Single point safety release

Electric / hydraulic HVLP power system

Four triple-telescoping arm design

Dual hydraulic direct-drive cylinders



Asymmetric Configuration

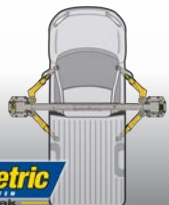

Symmetric Configuration



Low Profile Arms

Medium / Heavy Duty Floor Plate

SERIES FEATURES:

- Adjustable width design
- Dual hydraulic lifting cylinders
- Single-piece columns
- Single point safety release
- Drop-end arms provide a lower pad height
- Triple-telescoping arms
- Electric / hydraulic system
- Self-lubricating dura-glide UHMW polyethylene bearing system
- Automatic arm restraints
- 4-piece stackable adapter set (XPR-9's)
- Telescoping screw pads
- Durable powder coat finish
- Safety locks in each column spaced every 3.75 inches
- Open top design
- Large steel base plates
- Heavy-duty 3/8" equalizer cables
- Rugged steel construction

XPR-9TF Medium Floor Plate

#5175308



Lifting Capacity - 9,000 lbs.
Max. Lifting Height - 73"
Width - 132" / Height - 123.25"

XPR-12FDL Heavy-Duty Floor Plate

#5175403



Includes 16-Piece Adapter Set

Lifting Capacity - 12,000 lbs.
Max. Lifting Height - 75"
Width - 155" / Height - 144.75"

Low-Pro™ Arms



2-stage low-profile arms featured on LP lift models



XPR-9TF



Triple-Telescoping Arms

EV Battery Scissor Lift

ALL NEW EV BATTERY & POWERTRAIN LIFTING SYSTEM

3,000 LB. CAPACITY

BendPak Mobi-EVS EVS3000 Portable EV Battery Lift

SKU 5175611

- Platform Capacity - 3,000 lbs.
- Max. Platform Height - 77.75"
- Platform Size - 42.75" x 63"

4,500 LB. CAPACITY

BendPak Mobi-EVS EVS4500 Portable EV Battery Lift

SKU 5175613

- Platform Capacity - 4,500 lbs.
- Max. Platform Height - 77.75"
- Platform Size - 42.75" x 63"

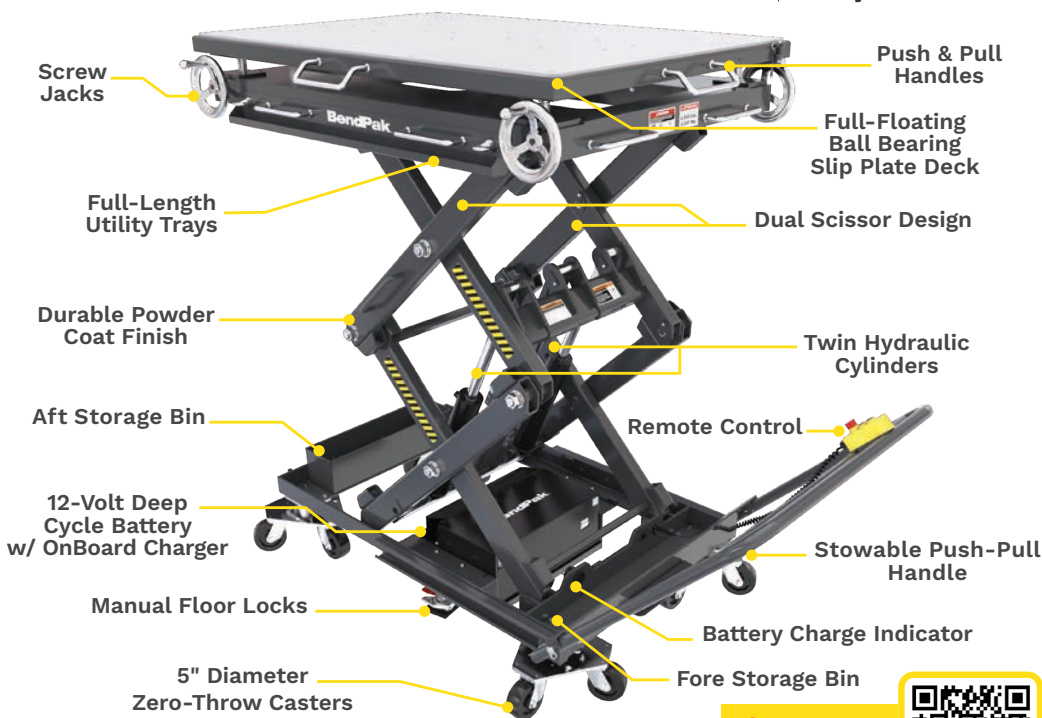

SEE IT IN ACTION!



OPTIONAL MOBI-EVS ADAPTERS



Universal Deck Mount Kit
#5216234



Mobi-EVS Fixture Set
#5210458



Transmission Support
#5323189



Multi-Point Support Kit
#5216205



Telescoping Arm Kit
#5210454

Heavy-Duty Clearfloor

SERIES FEATURES:

- Dual-synchro equalization system
- Electric / hydraulic power system
- UHMW polyethylene bearings
- Single-piece columns
- Dual" Direct-Drive" cylinders
- Single point safety release
- Automatic arm restraints
- 8-piece stackable adapter pins
- Oversized column base plates
- Padded safety-shutoff bar
- Safety locks in each column
- Heavy-duty 1/2" equalizer cables
- Powder coat finish
- Rubber door bumpers
- Versatile drop in contact pads with convenient storage
- Triple-telescoping arms
- Extended height top-beam provides greater overhead clearance
- Oversized cable sheave diameter
- Rubber lift pads with stackable adapters

12APX Clearfloor #5175556



Includes
12-Piece Adapter Set

Lifting Capacity - 12,000 lbs.
Max. Lifting Height - 79"
Width - 155.75" / Height - 169"

XPR-15CL Clearfloor #5175408



Includes
12-Piece Adapter Set

Lifting Capacity - 15,000 lbs.
Max. Lifting Height - 75.25"
Width - 155" / Height - 170"

XPR-18CL Clearfloor #5175409



Includes
16-Piece Adapter Set

Lifting Capacity - 18,000 lbs.
Max. Lifting Height - 75.25"
Width - 155" / Height - 170"

XPR-12CL-LTA Long-Reach Telescoping Arms #5175258



Includes
12-Piece Adapter Set

Lifting Capacity - 12,000 lbs.
Max. Lifting Height - 75.5"
Width - 155" / Height - 170"

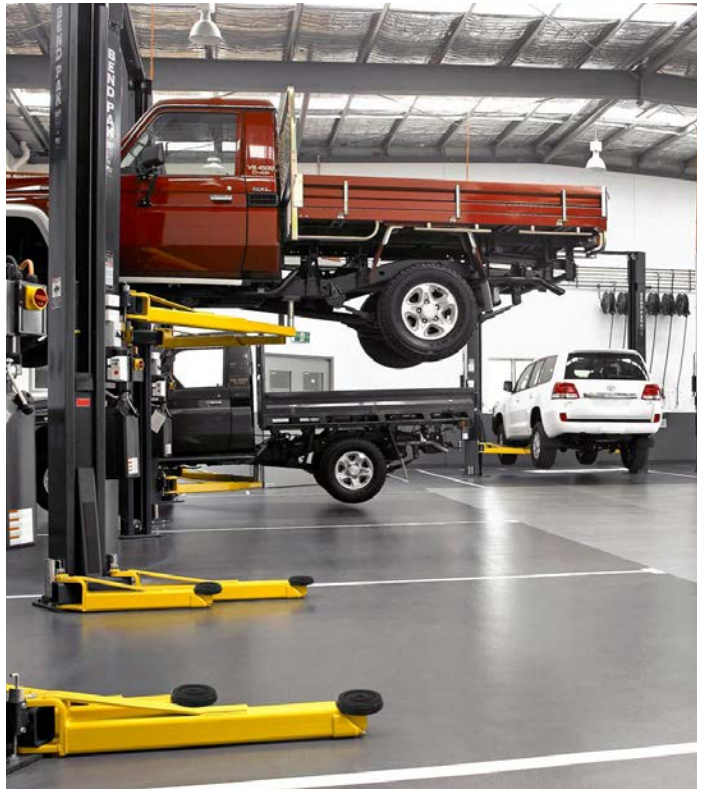

12-Piece Adapter Set



Included on all truck two-post models

Variability in Specifications and Features: All product specifications and features listed in this catalog are for reference only. For a more accurate and comprehensive listing of product specifications and features, visit www.bendpak.com. The contents of this catalog are subject to change.

ACCESSORIES:



Frame Cradle Pads
#5215761 (set of 4)



Wide Frame Cradle Pads
#5215848 (set of 2)



Mobile High-Lift Jack Stand
#5175001



Steel Lift Pads
#5215763 (set of 4)



Air / Electric Workstation
#5210438

MADE STRONG™



XPR-15CL
(Shown with optional
air/electric workstation)
#5175408

Padded overhead safety shutoff bar

Oversized cable sheave diameter
reduces cable fatigue

- Heavy-duty 1/2" aircraft-quality equalizer cables
- Safety locks every 3.75"

- XPR-12CL-192** #5175407
- XPR-15CL-192** #5175410
- XPR-18CL-192** #5175411



XPR-12CL-192-LTA #5175259
Features bolt on
top extension for
added 24" clearance

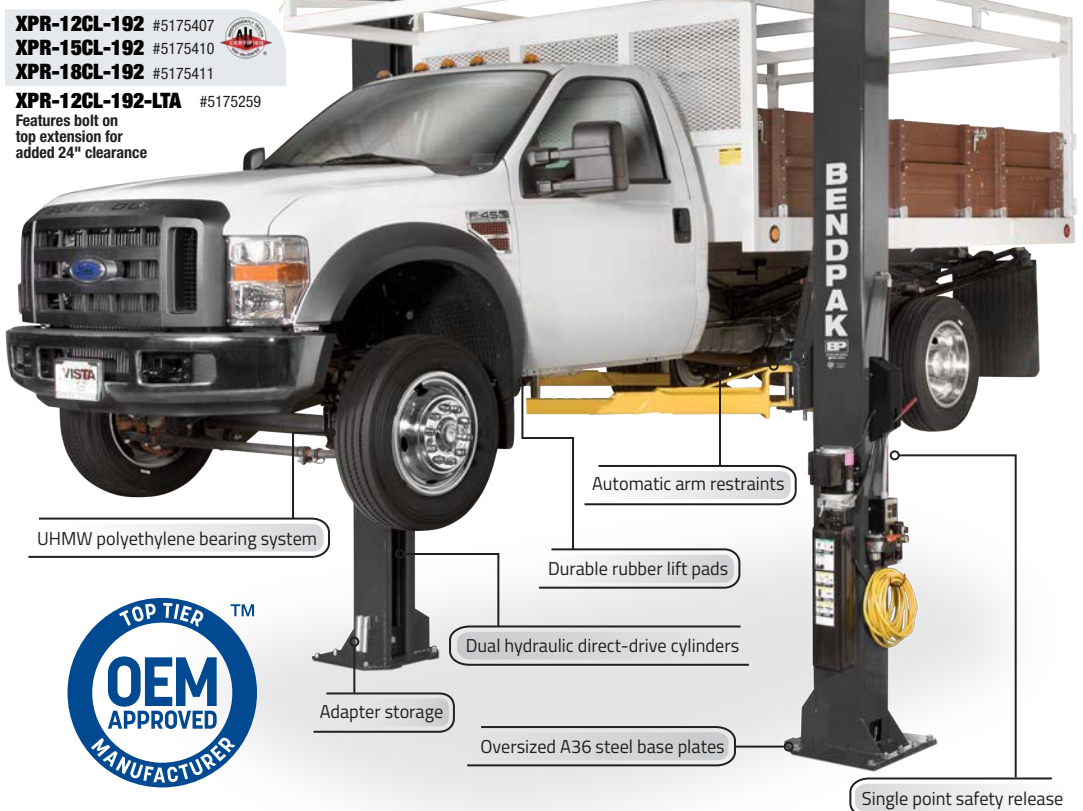

UHMW polyethylene bearing system

Automatic arm restraints

Durable rubber lift pads

Dual hydraulic direct-drive cylinders

Adapter storage

Oversized A36 steel base plates

Single point safety release



WHEN BALANCING SAFETY AND BENDPAK GOES THE

LONG-REACH ARMS PROVIDE BETTER CENTER-OF-GRAVITY LOADING

When servicing trucks and vans with extremely long wheelbases, longer-reach arms deliver a more stable lifting solution. The lengthy triple-telescoping arms on BendPak's new **ALI Certified 12APX** extend to 72" long – that's six feet in length and over one foot longer than almost any other lift or brand in its class. And with rugged BendPak dependability combined with a 16-piece adapter set, you'll realize that balancing safety* and worker productivity has never been so perfectly matched. For more information visit www.bendpak.com/LTA or call **1-800-253-2363**.



www.bendpak.com/LTA ■ 1-800-253-2363

D PRODUCTIVITY, DISTANCE.

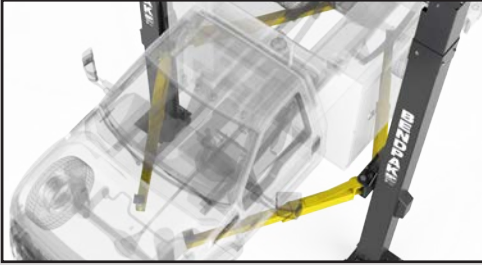

- 12,000-lb. lifting capacity
- Dual direct-drive hydraulic cylinders
- Oversized 53" tall carriage for superior strength and durability



3-stage long-reach telescoping arms

Oversized A36 steel base plates

*Always read and follow all safety warnings that accompanied your lifting equipment at the time of purchase. More information regarding vehicle lift safety is available directly from BendPak or from the Automotive Lift Institute.



BendPak®

2-Post / 4-Post Lifts

DELIVERING QUALITY AND VALUE:

Dannmar's car lifts deliver quality you can rely on. But it all starts with surpassing your expectations. Like you, we know that when you put a vehicle up in the air, there are a few things you count on right away. First are safety, quality, and vehicle access. Dannmar easily delivers on all three of these. Our design and manufacturing process is based on an effort to have all of our automotive lifts ANSI/ALI certified. Dannmar's lifts are built from a history of carefully exceeding the needs of the vehicle repair industry for over 50 years and most importantly always looking for what's next.

D4-9 PACKAGES INCLUDE:

- D4-9 or D4-9X four-post lift
- Caster kit
- Plastic drip trays (set)
- JP45 sliding jack trays
- Aluminum approach ramps (set)



**D2-8F
Two-Post Lift**
#5175316



WHILE SUPPLIES LAST

Lifting Capacity - 8,000 lbs.
Max. Rise - 72"
Width - 132" or 145" / Height - 113"

**D2-10C
Two-Post Lift**
#5175314

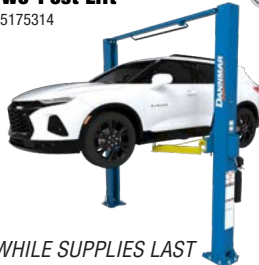

WHILE SUPPLIES LAST

Lifting Capacity - 10,000 lbs.
Max. Rise - 69"
Width - 145.25" / Height - 145"

**D2-10A
Two-Post Lift**
#5175313



WHILE SUPPLIES LAST

Lifting Capacity - 10,000 lbs.
Max. Rise - 69"
Width - 143.5" / Height - 145"

**D2-12C
Heavy Duty
Two-Post Lift**
#5175312



WHILE SUPPLIES LAST

Lifting Capacity - 12,000 lbs.
Max. Rise - 69"
Width - 155.25" / Height - 168.75"

**D2-15C
Heavy-Duty
Two-Post Lift**
#5175311



WHILE SUPPLIES LAST

Lifting Capacity - 15,000 lbs.
Max. Rise - 69"
Width - 155.25" / Height - 168.75"

**D4-9 Package
Four-Post Lift**
#5175319



WHILE SUPPLIES LAST

Lifting Capacity - 9,000 lbs.
Max. Rise - 70" / Runway Length - 165.5"
Width - 114.5" / Length - 203"

**D4-9X Package
Four-Post Lift**
#5175321



WHILE SUPPLIES LAST

Lifting Capacity - 9,000 lbs.
Max. Rise - 82" / Runway Length - 189.75"
Width - 114.5" / Length - 227"

**D4-12
Four Post Lift**
#5175317



WHILE SUPPLIES LAST

Lifting Capacity - 12,000 lbs.
Max. Rise - 68.75" / Runway Length - 194.75"
Width - 127.5" / Length - 233.5"

**D4-12A
Alignment
Four-Post Lift**
#5175318



WHILE SUPPLIES LAST

Max. 2 Wheel Align. - 163.5" / Max Rise - 68.75"
Capacity - 12,000 lbs. / Runway Length - 194.75"
Width - 127.5" / Length - 233.5"

Light-Duty / Medium-Duty Home Garage

GP-7 SERIES FEATURES:

- 7,000-lb lifting capacity
- Telescoping Low-Pro™ arms for sports cars
- Bi-metric asymmetric & symmetric arm configuration
- Lowered arm tube supports
- Automatic arm restraints
- Taller lift carriages
- Single release-point operation
- Automatic safety locks
- Single hidden hydraulic cylinder
- (2) redundant safety cables
- Multiple lock positions
- Powder coat finish

GP-9 SERIES FEATURES:

- 9,000-lb lifting capacity
- Fastened to the floor or free-standing
- Boxed-steel columns
- 3/4" thick, automatic safety locks
- Welded-steel tread-plate runways
- Stainless steel lifting cables
- Pull out tire stops on both ends of the lift

GP-7LCS Short Height

#5175995

WHILE SUPPLIES LAST



Lifting Capacity - 7,000 lbs.
Max. Lifting Height - 56.75"
Width - 125" / Height - 106.5"

GP-7LC Medium Height

#5175996

WHILE SUPPLIES LAST



Lifting Capacity - 7,000 lbs.
Max. Lifting Height - 67.75"
Width - 125" / Height - 118.5"

GP-7 Tall Height

#5175992

WHILE SUPPLIES LAST



Lifting Capacity - 7,000 lbs.
Max. Lifting Height - 78.25"
Width - 125" / Height - 150"

GP-9F Standard

#5175254



WHILE SUPPLIES LAST

Lifting Capacity - 9,000 lbs.
Max. Lifting Height - 70.25"
Runway Length - 165.5"

GP-9XLT Tall / Long

#5175127



WHILE SUPPLIES LAST

Lifting Capacity - 9,000 lbs.
Max. Lifting Height - 82.5"
Runway Length - 189.75"

GP-7LCS

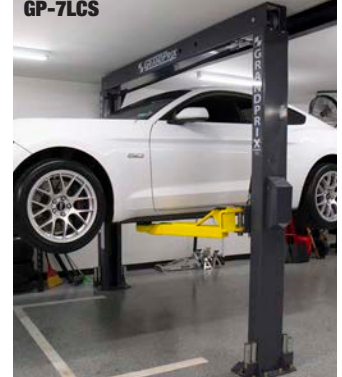

GP-9F

GP-9 MODELS INCLUDE



Polyethylene Drip Trays

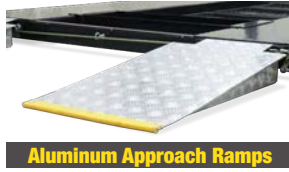

Aluminum Approach Ramps



Mobile Jack Tray



Quick-Mount Casters

4-Post Light-Duty

SERIES FEATURES:

- Runways feature non-skid surface
- Single hydraulic cylinder under ramp
- Fully enclosed lifting cables, safety locks and sheaves
- Pneumatic push-button safety release
- Features 1-1/4" sheave axles
- Features heavy-duty 3/8" aircraft cable
- Internal "anti-sway" slider blocks in each column
- Electric / hydraulic power system
- Oversized sheave diameters
- Rugged, self-lubricating cable sheaves
- Multi-position safety locks in columns
- Dual-position power unit locations
- Redundant slack-cable safety latches
- Fully adjustable lock leveling stops
- Drive through ramps option available
- 36" approach ramps available
- Durable powder coat finish
- Rugged steel construction
- High-speed lifting

HD-7P Narrow

#5175510



Lifting Capacity - 7,000 lbs.
Max. Lift Height - 86" / Runway Length - 164"
Width - 100.25" / Length - 200.5"

HD-7W Wide

#5175120



Lifting Capacity - 7,000 lbs.
Max. Lift Height - 86" / Runway Length - 164"
Width - 111.75" / Length - 200.5"

HD-7PXW Super-Tall

#5175516



Lifting Capacity - 7,000 lbs.
Max. Lift Height - 144" / Runway Length - 188"
Width - 111.75" / Length - 224.5"

HD-7500BLX Standard Length Boat Lift

#5175315



Lifting Capacity - 7,500 lbs.
Max. Lift Height - 82" / Runway Length - 188.5"
Width - 132" / Length - 224"

HD-75BXT Extended Length Boat Lift

#5175251



Lifting Capacity - 7,500 lbs.
Max. Lift Height - 82" / Runway Length - 213"
Width - 134" / Length - 249"

HD-7500PBX Extended Height Boat Lift

#5175320



Lifting Capacity - 7,500 lbs.
Max. Lift Height - 144.5" / Runway Length - 213"
Width - 134" / Length - 249"

SHIP, DELIVER & INSTALL. WE DO IT ALL.

Shop Planning • Above Ground Lift Installation • Painless Equipment Delivery

SERVICE IS OUR SPECIALTY

BendPak has a network of installation and service teams throughout the United States authorized to provide installation and support on all of the products we sell. With over 700 service centers, you can rest assured that the products you purchase from BendPak are backed by a nationwide team of qualified service personnel. At BendPak, we've made a commitment to offer unparalleled service and support. More than just a seller, we want to be your automotive equipment partner for life.

FREE SHIPPING*

At BendPak, we are dedicated to delivering your purchase as quickly and affordably as possible. All products marked FREE SHIPPING include FREE destination delivery to all direct shipping points within the 48 contiguous United States. For heavy equipment purchases, we offer a range of delivery and pick-up options so you can choose the shipping method that best meets your needs.



WE SHIP



WE DELIVER



WE INSTALL

EASY TO ORDER – DELIVERED RIGHT TO YOUR DOOR

Ordering lifts or shop equipment from BendPak is fast and easy. Whether for the shop or home, we'll make sure your order is delivered to you as fast and conveniently as possible. And we'll arrange the installation and set-up as well if you wish. Placing an order takes just minutes. Either call and speak to one of our courteous specialists or place your order online and click your way through. If you ever need assistance or advice, our friendly consultants are only a phone call away. We look forward to serving you.

IF YOU FIND A LOWER PRICE, WE'LL MATCH IT OR BEAT IT - GUARANTEED.

If you find a lower price anywhere on an identical BendPak™ or Ranger™ brand product sold in the United States, show us the lower advertised price at the time of purchase and we will match it on the spot. Or show us the lower price within 14 days of your purchase and we will pay you the difference. We will not match other retailer's mail-in rebates nor will we deduct the value of any gift with purchase.

BendPak reserves the right to verify all information. Our low-price guarantee covers identical BendPak and Ranger branded items with the same model number, features and U.S. warranty. The item must be in stock and available for purchase at the price as advertised. We reserve the right to call and verify that the item is in stock and available for purchase at the price as advertised. Low price guarantee applies only to items shown in this flyer. Taxes, ad errors, closeouts, clearance, liquidation, free product offers, special orders, offers advertised at a specific location and refurbished items are also excluded from this guarantee.



4-Post Medium-Duty

SERIES FEATURES:

- Freestanding or bolt-down design
- Runways feature non-skid surface
- Single hydraulic cylinder under ramp
- Fully enclosed lifting cables, safety locks and sheaves
- Pneumatic push-button safety release
- Features 1-1/4" sheave axles
- Internal "anti-sway" slider blocks in each column
- Features heavy-duty 3/8" aircraft cable
- Longer ramps for low ground clearance vehicles
- Oversized sheave diameters
- Rugged, self-lubricating cable sheaves
- Multi-position safety locks in columns
- Dual-position power unit locations
- Redundant slack-cable safety latches
- Fully adjustable lock leveling stops
- Drive through ramps option available
- 36" approach ramps available
- Perfect for parking, storage and service

HD-9 Wide Standard

#5175861



Lifting Capacity - 9,000 lbs.
Max. Lift Height - 70" / Runway Length - 164"
Width - 110.25" / Length - 200"

HD-9ST Narrow Standard

#5175860



Lifting Capacity - 9,000 lbs.
Max. Lift Height - 70" / Runway Length - 164"
Width - 100.25" / Length - 200"

HD-9STX Narrow Tall Long

#5175862



Lifting Capacity - 9,000 lbs.
Max. Lift Height - 82" / Runway Length - 188"
Width - 100.25" / Length - 224"



HD-9ST

HD-9XW Wide Tall Long

#5175863



Lifting Capacity - 9,000 lbs.
Max. Lift Height - 82" / Runway Length - 188"
Width - 110.25" / Length - 224"

HD-9



HD-9XL Wide Standard Long

#5175859



Lifting Capacity - 9,000 lbs.
Max. Lift Height - 70" / Runway Length - 188"
Width - 110.25" / Length - 224"

Variability in Specifications and Features: All product specifications and features listed in this catalog are for reference only. For a more accurate and comprehensive listing of product specifications and features, visit www.bendpak.com. The contents of this catalog are subject to change.

ACCESSORIES:

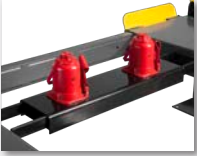

Jack Platform
(Jacks not included)



Caster Kit
#5210997



RBJ4500 Rolling Bridge Jack
#5175988 (ea)

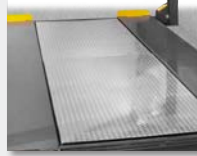

Aluminum Deck



Drip Trays
#5700301 (set of 2)

HD-9SW Double Wide Standard

#5175023



Lifting Capacity - 9,000 lbs.
Max. Lift Height - 70" / Runway Length - 164"
Width - 202" / Length - 200"

HD-9SWX Double Wide Tall Long

#5175024



Lifting Capacity - 9,000 lbs.
Max. Lift Height - 82" / Runway Length - 188"
Width - 202" / Length - 224"



HD-9 Series

Oversize self-lubricating cable sheaves

- Push button pneumatic safety release
- Electric/hydraulic power system
- Optional power unit locations

Independent backup slack-cable safety latches

Optional rolling bridge jacks

Adjustable lock ladders

Rugged 1-1/4" roller axles

Longer approach ramps

- Heavy-duty 3/8" aircraft cables
- Multi-position safety locks



See it on the BendPak / Ranger YouTube Page

Options/Accessories



Caster Kit #5210997
Fits HD-7 & HD-9 Series



RJ45W #5175247
Rolling Bridge Jack



JP-45 #5215825
4,500 lb. Capacity Jack Platform



(Bottle jacks not included)
JP-6 Telescoping #5175349
6,000 lb. Capacity Jack Platform



WSA-100 #5210438
Air Electric Workstation

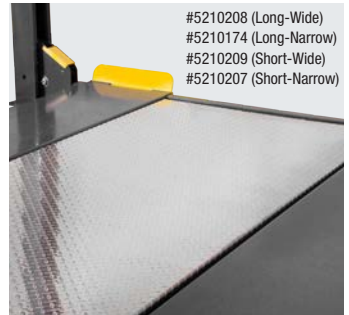

#5210208 (Long-Wide)
#5210174 (Long-Narrow)
#5210209 (Short-Wide)
#5210207 (Short-Narrow)
Solid Aluminum Decks

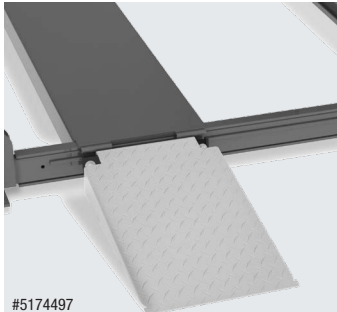

#5174497
Aluminum Approach Ramps
Width - 19.75" / Length - 36.75"

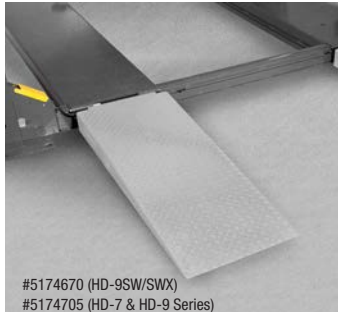

#5174670 (HD-9SW/SWX)
#5174705 (HD-7 & HD-9 Series)
Extended Alum. Approach Ramps
Width - 19.75" / Length - 48"

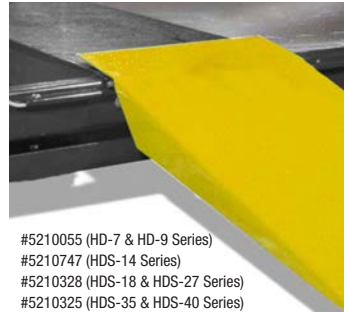

#5210055 (HD-7 & HD-9 Series)
#5210747 (HDS-14 Series)
#5210328 (HDS-18 & HDS-27 Series)
#5210325 (HDS-35 & HDS-40 Series)
Extended Steel Approach Ramps
Width - 19.75" / Length - 48"



Caster Kit



Solid Aluminum Decks

Rechargeable Work Light



LITESTIX™

By BendPak



LiteStix LS36MDX
Rechargeable
Work Light

#5150063



LITESTIX™ LS36MDX is a versatile LED portable work light designed for heavy-use. A total of 36 super-bright LED bulbs provide brilliant lighting coverage anywhere you need, perfect for night time and other low-light projects. The LITESTIX™ LS36MDX includes a large-capacity 2,600 mAh Li-ion battery that has been thoroughly tested to last up to 7 hours of continuous use. An impact resistant polycarbonate light housing, all-steel telescoping light tube holder latches from 49" to 79" lengths, and two swivel-head mounts with built-in magnets provide all the flexibility and versatility to illuminate your next project.

STRONG MAGNETIC ENDS



1200
LUMENS

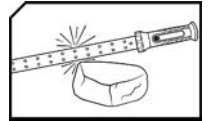
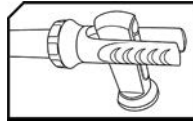
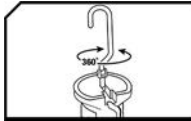
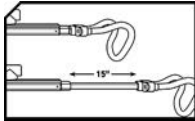

UP TO 7 HOURS OF
CONTINUOUS USAGE



STRONG
MAGNETIC ENDS



TWO ACCESSIBLE
POWER BUTTONS



RECHARGEABLE
LITHIUM-ION



HIGH AND LOW
BRIGHTNESS SETTINGS

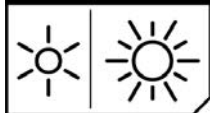

4-Post Heavy-Duty

SERIES FEATURES:

- Adjustable runway widths
- Single hydraulic cylinder under ramp
- Fully enclosed lifting cables, safety locks and sheaves
- Pneumatic push-button safety release
- Features heavy-duty aircraft cable
- Runways feature non-skid surface
- Internal "anti-sway" slider blocks in each column
- Longer ramps for low ground clearance vehicles
- Oversized sheave diameters
- Rugged, self-lubricating cable sheaves
- Features heavy-duty sheave axles
- Multi-position safety locks in columns
- Dual-position power unit locations
- Redundant slack-cable safety latches
- Fully adjustable lock leveling stops
- Drive-through ramps option available
- 48" approach ramps available
- Customizable power unit location

HDS-14 Standard Length

#5175170



HDS-14X Extended Length

#5175173



HD-14T Super Tall

#5175004



Lifting Capacity - 14,000 lbs.
Max. Lift Height - 70" / Runway Length - 203"
Width - 131.75" / Length - 241"

Lifting Capacity - 14,000 lbs.
Max. Lift Height - 70" / Runway Length - 233"
Width - 131.75" / Length - 271"

Lifting Capacity - 14,000 lbs.
Max. Lift Height - 82" / Runway Length - 195"
Width - 127.5" / Length - 234"

HDSO-14P Open Front Standard Length

#5175152



HDS-18E Standard Length

#5175968



HDS-27 Standard Length

#5175162



Lifting Capacity - 14,000 lbs.
Max. Lift Height - 70" / Runway Length - 199"
Width - 143" / Length - 244"

Lifting Capacity - 18,000 lbs.
Max. Lift Height - 61.25" / Runway Length - 257.5"
Width - 153.5" / Length - 312.75"

Lifting Capacity - 27,000 lbs.
Max. Lift Height - 61.25" / Runway Length - 257.5"
Width - 153.5" / Length - 312.75"

HDS-18E



HDS-27X



Variability in Specifications and Features: All product specifications and features listed in this catalog are for reference only. For a more accurate and comprehensive listing of product specifications and features, visit www.bendpak.com. The contents of this catalog are subject to change.

ACCESSORIES:



Rolling Bridge Jack



DP-30 Rolling Oil Drain
#5150509



Air / Electric Workstation
#5210436



Rolling Bridge Airline Kit
#5174010

HDS-27X Extended Length

#5175164



Lifting Capacity - 27,000 lbs.
Max. Lift Height - 61.25"
Runway Length - 317.5"
Width - 153.5" / Length - 372.75"

HDS-40 Standard Length

#5175176



Lifting Capacity - 40,000 lbs.
Max. Lift Height - 61.25"
Runway Length - 244.5"
Width - 153.5" / Length - 313.75"

HDS-40X Extended Length

#5175178



Lifting Capacity - 40,000 lbs.
Max. Lift Height - 61.25"
Runway Length - 304.5"
Width - 153.5" / Length - 373.5"

HDS-40X Shown with optional rolling bridge jacks

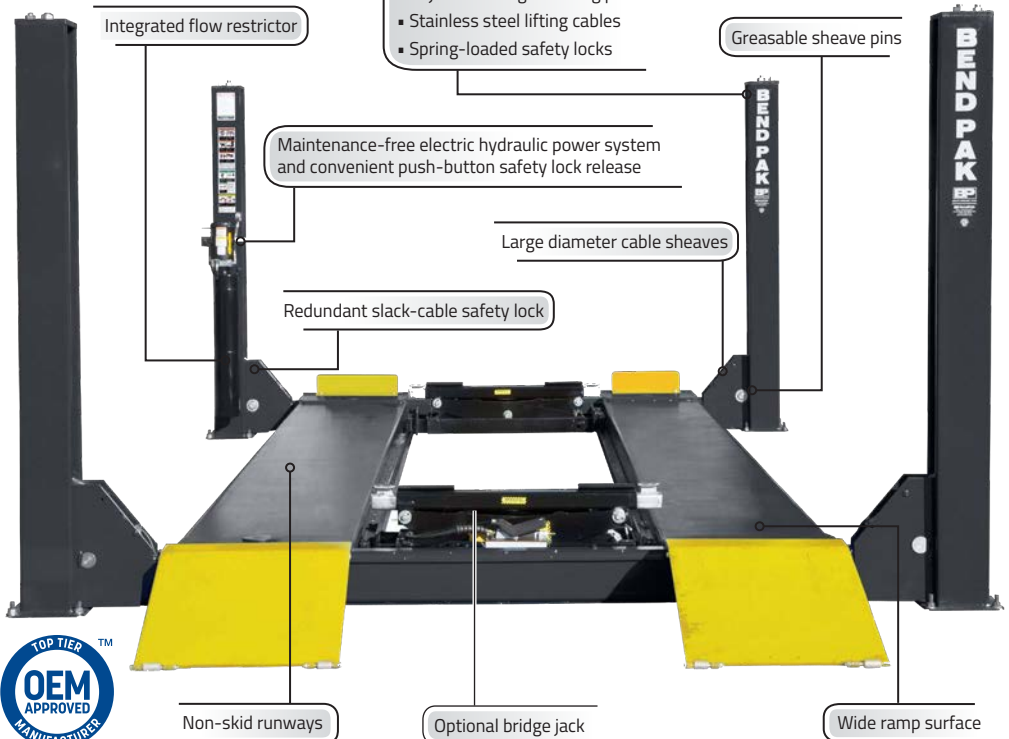

Alignment Lifts

SERIES FEATURES:

- Runways adjust to different widths
- Multi auto-level locking positions
- Single hydraulic cylinder
- Fully enclosed lifting cables and sheaves
- Pneumatic push-button safety release
- Heavy-duty aircraft cable
- Runways feature non-skid surface
- Self-lubricating cable sheaves
- Oversized sheave diameter
- Features heavy-duty sheave axles
- Fully adjustable lock stops
- Drive through ramps available
- Rolling bridge airline kit available
- Roll back kit available



Equipped with rear slip plates and galvanized front turn plates

HD-9AE Alignment Lift

#5175820



Max. 2 Wheel Align. - 160" / Max. Lift Height - 70"
Capacity - 9,000 lbs. / Runway Length - 188"
Width - 127" / Length - 224"

HDSO-14AX Open Front

#5175153



Max. 2 Wheel Align. - 182" / Max. Lift Height - 70"
Capacity - 14,000 lbs. / Runway Length - 199"
Width - 143" / Length - 243"

HDS-14LSX Extended Length

#5175171



Max. 2 Wheel Align. - 182" / Max. Lift Height - 70"
Capacity - 14,000 lbs. / Runway Length - 199"
Width - 130" / Length - 241"

HDS-14LSXE Limo Extended Length

#5175172



Max. 2 Wheel Align. - 212" / Max. Lift Height - 70"
Capacity - 14,000 lbs. / Runway Length - 229"
Width - 130" / Length - 271"



HDS-18EA Truck Alignment

#5175969



Max. 2 Wheel Align. - 211" / Max. Lift Height - 59"
Capacity - 18,000 lbs. / Runway Length - 257.5"
Width - 153.5" / Length - 312.75"



Rolling Bridge Jacks

SERIES FEATURES:

- 4,500 - 25,000 lb. lifting capacity
- Versatile drop in lifting pads
- Multi-piece adapter set standard
- High-pressure hydraulic power unit
- Stackable adapters
- Automatic safety locks
- Three safety-lock positions
- Rubber lifting pads or steel lifting pads come standard or optional
- Optional air-line kit
- Raise 2 or 4 wheels off the runways
- Telescoping roller design allows the runways to be adjusted for different tread widths



RJ45W Rolling Jack

#5175247



Lifting Capacity - 4,500 lbs.
Arm Reach - 42" - 57"
Frame Reach - 35.5" - 46.5"

RJ6W Rolling Jack

#5175248



Lifting Capacity - 6,000 lbs.
Arm Reach - 42" - 56"
Frame Reach - 36.25" - 47.25"

RJ7W Rolling Jack

#5175249



Lifting Capacity - 7,000 lbs.
Arm Reach - 42" - 56"
Frame Reach - 36.25" - 46.5"

RJ9W Rolling Jack

#5175252



Lifting Capacity - 9,000 lbs.
Arm Reach - 42" - 56"
Frame Reach - 45" - 50"

RBJ15000 Rolling Jack

#5175031



INCLUDES:
8-Piece Adapter Set

Lifting Capacity - 15,000 lbs.
Arm Reach - 48.5" - 63.75"
Frame Reach - 45.75" - 59"

RBJ18000 Rolling Jack

#5175032



INCLUDES:
8-Piece Adapter Set

Lifting Capacity - 18,000 lbs.
Arm Reach - 48.5" - 63.75"
Frame Reach - 45"

RBJ25000 Rolling Jack

#5175033



INCLUDES:
8-Piece Adapter Set

Lifting Capacity - 25,000 lbs.
Arm Reach - 48.5" - 63.75"
Frame Reach - 45"





Revolutionizing Vehicle Service

Raising the Standards of Safety

CONCEPT

**COMING
SOON**



- 2 Lifts in 1
- 12,000-lb. Capacity
- Integrated Lift Assist Arms
- Pendant Controls



360° Automatic Swing Arm Restraint System

Patent Pending*



LEARN MORE



Optional Side Shift & Leveling Platform



Optional Aluminum Cross Beam Support Beams



Optional Shuttle Bench with Side Shift and Leveling Platform

Mobile Lift Features & Specifications

Portable Column Lift

SERIES FEATURES:

- 18,000-lb. individual column capacity
- 144,000-lb. maximum system capacity with 8 units
- SINGLE, PAIR or TEAM operation
- Three, 30' cables are used, leaving the front or back of the lift clear of cables
- Self-diagnostics and self-calibration
- Control systems feature 24-volt circuitry
- Variable height limit settings
- Two-speed lowering option settings
- Equipped with a warning light and audible alarm for critical warning alerts
- Emergency shutoff on each column
- Key lock enclosure on each column
- Electronics are multi-fuse protected
- Enclosed electric-hydraulic power system
- Pallet-jack style steering wheels
- Extended forks accommodate wide tires and deep wheel configurations
- Multi-width wheel forks with locking pins
- Tandem 8" diameter polyurethane covered steel wheels

PCL-18B (Set of 4)

#5175292



Column Capacity - 18,000 lbs.
System Capacity - 72,000 lbs.
Lifting Height - 71.5"

PCL-18B (Set of 6)

#5175293



Column Capacity - 18,000 lbs.
System Capacity - 108,000 lbs.
Lifting Height - 71.5"

PCL-18B (Set of 8)

#5175294

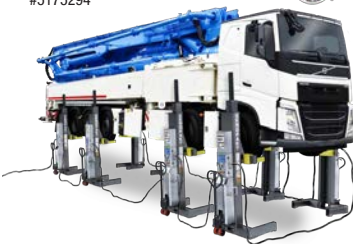

Column Capacity - 18,000 lbs.
System Capacity - 144,000 lbs.
Lifting Height - 71.5"

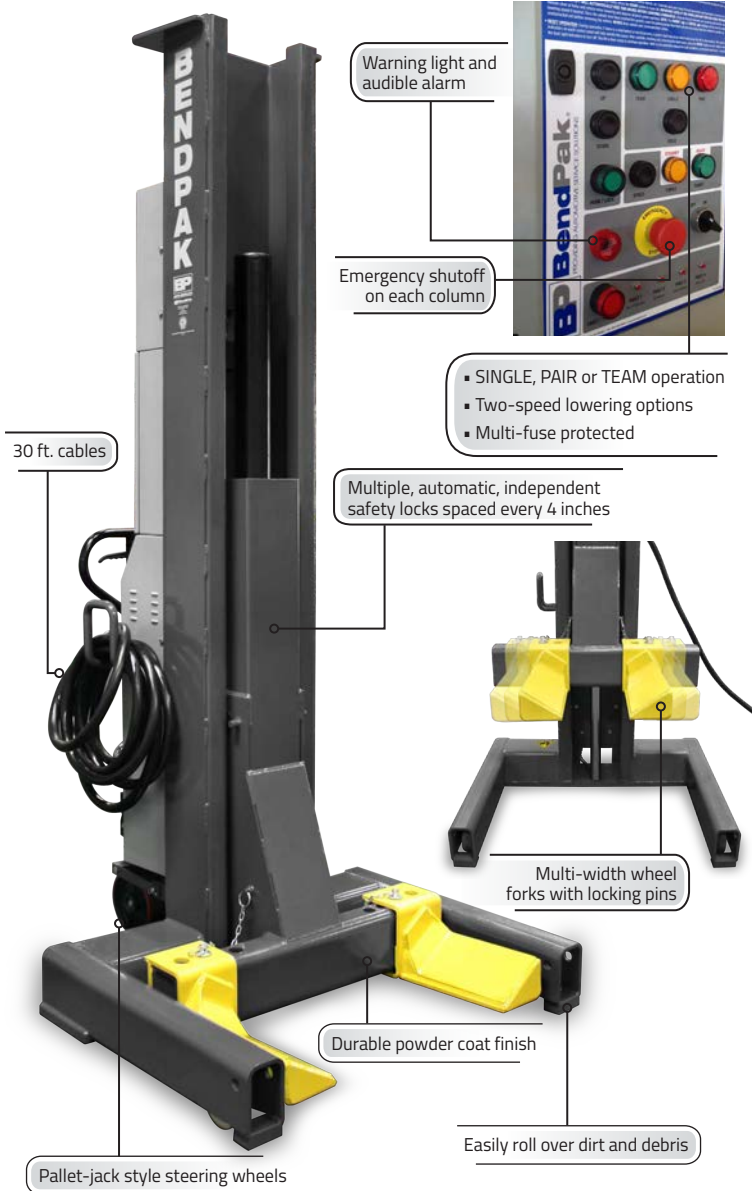

Low-Rise / Mid-Rise / Full-Rise

SERIES FEATURES:



MD-6XP Model
Multi-piece Adapter Set



SP-7X & All Low-Rise Models
1.5" Rubber Lift Blocks



Portable Models
Mobile Power Cart

LR-60 Low-Rise Lift

#5175729



Comes standard
with rubber lift blocks

Lifting Capacity - 6,000 lbs.
Lift Pad Dimensions - 18" x 52"
Height Range - 3.75" - 25"

LR-60P Low-Rise Portable Lift

#5175728



Comes standard
with rubber lift blocks

Lifting Capacity - 6,000 lbs.
Lift Pad Dimensions - 18" x 52"
Height Range - 3.5" - 25"

MD-6XP Mid-Rise Portable Lift

#5175730



Comes standard
with adapter set

Lifting Capacity - 6,000 lbs.
Adjustable Arms
Height Range - 4.75" - 47"

MD-6XP

#5175730



PORTABLE LIFT

Portable Models Mobile Power Cart



Variability in Specifications and Features: All product specifications and features listed in this catalog are for reference only. For a more accurate and comprehensive listing of product specifications and features, visit www.bendpak.com. The contents of this catalog are subject to change.

ACCESSORIES:



1.5" Rubber Lift Blocks



3" Rubber Lift Blocks



6" Rubber Lift Blocks

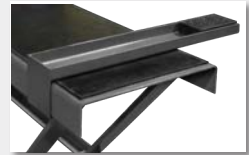

LR-4A Arm Kit
#5210944

P9000LT Low-Rise Pit Lift

#5175133



Comes standard with rubber lift blocks

Lifting Capacity - 9,000 lbs.
Lift Pad Dimensions - 24" x 58.5"
Height Range - 4" - 23.75"

P9000LTF Low-Rise Pit Lift Flush Mount

#5175155



Comes standard with rubber lift blocks

Lifting Capacity - 9,000 lbs.
Lift Pad Dimensions - 24" x 68.5"
Height Range - 4" - 23.75"

Optional P-9000 Series Telescoping Arm Kit

#5210194



Capacity / Each arm - 2,250 lbs.
(4) Lift Arms • (4) Contact pads

LR10000 Low-Rise Lift

#5175232



Comes standard with 8-pc. adapter set

Lifting Capacity - 10,000 lbs.
Lift Pad Dimensions - 24" x 5"
Height Range - 4.5" - 23"

MDS-6LP Mid-Rise Scissor Lift

#5175226



Comes standard with rubber lift blocks

Lifting Capacity - 6,000 lbs.
Lift Pad Dimensions - 19" x 67"
Height Range - 5" - 44.5"

MDS-6LPF Mid-Rise Scissor Lift Flush Mount

#5175227



Comes standard with rubber lift blocks

Lifting Capacity - 6,000 lbs.
Lift Pad Dimensions - 19" x 67"
Height Range - 5" - 44.5"

SP-7XE Full-Rise Scissor Lift

#5175424



Comes standard with rubber lift blocks

Capacity - 7,000 lbs.
Lift Pad Dimensions - 22" x 62.5"
Height Range - 6.5" - 70.5"

SP-7XEF Full-Rise Flush Mount Scissor Lift

#5175425



Comes standard with rubber lift blocks

Capacity - 7,000 lbs.
Lift Pad Dimensions - 22" x 62.5"
Height Range - 6.5" - 70.5"

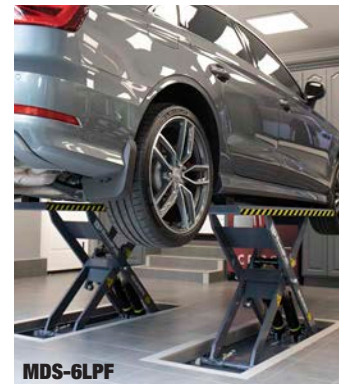

MDS-6LPF

Portable 2-Post Lifts

MAXJAX®

**M7K Portable
Two-Post Lift
Standard Package**
#5175548



PACKAGE INCLUDES:

M7K Portable Lift With All
Standard Accessories

**M7K Portable
Two-Post Lift
Deluxe Package**
#5175566

GOOD



PACKAGE INCLUDES:

M7K Portable Car Lift Upright
Oil Drain Rolling Work Seat

**M7K Portable
Two-Post Lift
Supreme Package**
#5175569

BETTER



PACKAGE INCLUDES:

M7K Portable Car Lift / Upright Oil Drain
Rolling Work Seat / 5" Tall Adapter
Pins Frame Cradle Pads

**M7K Portable
Two-Post Lift
Ultimate Package**
#5175572

BEST



PACKAGE INCLUDES:

M7K Portable Car Lift / Upright Oil Drain
Adjustable Creeper / 5" Tall Adapter Pins
Frame Cradle Pads

SERIES FEATURES:

- 7,000-lb Lifting capacity
- Maximum lifting height - 50.5"
- Minimum pad height - 5.5"
- Lock positions - 8 (every 3.7")
- Overall height - 89.5"
- Drive-thru clearance - 74" - 104"
- Motor - 110 VAC / 50-60 Hz / 1 Ph
- Strong steel construction
- Direct-drive, low-pressure cylinders
- Maintenance-free slide blocks
- Quick-disconnect self-sealing hose connection
- Built-in wheels that allow you to move it easily
- Automatic safety locks
- Optional motorcycle adapters are available

Variability in Specifications and Features: All product specifications and features listed in this catalog are for reference only. For a more accurate and comprehensive listing of product specifications and features, visit www.bendpak.com. The contents of this catalog are subject to change.

MAXJAX



The M7K. The bigger, badder MaxJax®. Everything you loved about the M6K is back, but now with an even higher lifting capacity. Our engineers found a way to let you safely lift up to 7,000 lbs. while still retaining a minimal footprint. Thanks to its unique portable two-post design, the MaxJax offers greater versatility and serviceability when compared to traditional mid-rise or low-rise garage lifting systems.



MOTORCYCLE / ATV ADAPTER #5215917

Our optional motorcycle adapter kit allows you to safely lift motorcycles, ATV's or other motorized vehicles to a comfortable working height.

- 1,500-lbs. capacity
- Simple Installation
- Non-slip polyurethane rubber pads
- Sturdy stainless steel construction



FLUSH-MOUNT ANCHORS

Supreme Package

Portable Lifts

QUICKJACK™

TOP SELLER

3500SLX
3,500-lb. Capacity
Portable Car Lift

#5175010



Lifting Height - 3" - 21"
Frame Width - 10.5"
Frame Length - 62.5"
Lift Point Spread - 27" - 50.5"

5000TL
5,000-lb Capacity
Portable Car Lift

#5175630



Lifting Height - 3" - 24"
Frame Width - 11"
Frame Length - 70"
Lift Point Spread - 37" - 60"



5000TLX
5,000-lb. Capacity
Portable Car Lift

#5175635



Lifting Height - 3" - 24"
Frame Width - 11"
Frame Length - 76"
Lift Point Spread - 43" - 66"



6000ELX
6,000-lb. Capacity
Portable Car Lift

#5175650



Lifting Height - 3.5" - 24.5"
Frame Width - 12.5"
Frame Length - 86.75"
Lift Point Spread - 53" - 76"



7000TL
7,000-lb. Capacity
Portable Car Lift

#5175640



Lifting Height - 3.5" - 24.5"
Frame Width - 12.5"
Frame Length - 70.75"
Lift Point Spread - 37" - 60"



7000TLX
7,000-lb. Capacity
Portable Car Lift

#5175645



Lifting Height - 3.5" - 24.5"
Frame Width - 12.5"
Frame Length - 76"
Lift Point Spread - 43" - 66"



ACCESSORIES:



Wall Hanger Set
#5210199



Truck Adapter Kit
#5150561



Frame Extensions
#5620291



ATV Lift Kit
#5150006



Crossbeam Adapters
#5215865 & #5215866



Motorcycle Lift Kit
#5300861



Pinch-Weld Pucks
#5300013



Round Pinch-Weld Pucks
#5300011



1.5" Low-Profile Blocks
#5300861

QuickJack Features

- Extended block trays
- Zero-leak fittings
- Open-center design
- 14-gauge welded steel frames
- Integrated power-assist canisters
- Quick-connect/disconnect hoses
- Includes eight piece set of adjustable rubber lift blocks
- Remote pendant control
- Steel mounted urethane wheels
- Dual-position automatic safety lock bars



6000ELX

QUICKJACK™

Parking & Storage Lifts

A6 SERIES FEATURES:

- 6,000-lb. lifting capacity
- Simple push button controls
- Dual, direct drive hydraulic lifting cylinders
- Automatic safety locks engage at six different parking heights
- Minimal footprint fits a typical parking space
- 100% hot-dipped, galvanized steel platform
- Accommodates cars, light trucks and SUVs

HD-973P SERIES FEATURES:

- Perfect for parking, storage and service
- Perfect for cars, trucks, and SUVs
- 7,000 lb. capacity upper deck
- 9,000 lb. capacity lower deck
- Padded trip bar with limit switch prevents lower vehicle from making contact with upper platform
- Galvanized option available

A6S Scissors Parking Lift

#5175274



Capacity - 6,000 lbs.
Lifting Height (Top Lock) - 81.25"
Overall Width - 103" / Length - 143"

A6W Extra Wide Scissors Parking Lift

#5175282



Capacity - 6,000 lbs.
Lifting Height (Top Lock) - 81.25"
Overall Width - 111" / Length - 144"

GALVANIZED OPTION AVAILABLE



A6S-G
A6W-G

HD-973P Tri-Level Parking Lift

#5175238



Capacity - 7K lbs. Top Deck / 9K lbs. Bot. Deck
Runway (L) - 188.5" / Overall Height - 161"
Width - 112" / Length - 242"

HD-973PX Tri-Level Parking Lift Extended

#5175267



Capacity - 7K lbs. Top Deck / 9K lbs. Bot. Deck
Runway (L) - 199" / Overall Height - 173"
Width - 112" / Length - 252.25"

GALVANIZED OPTION AVAILABLE



HD-973P-G
HD-973PX-G

PL-6000DC Two-Post Parking Lift

#5175427



Lifting Capacity - 6,000 lbs.
Lifting Height - 82.5" / Overall Height - 126.5"
Width - 100.25" / Length - 148.25"

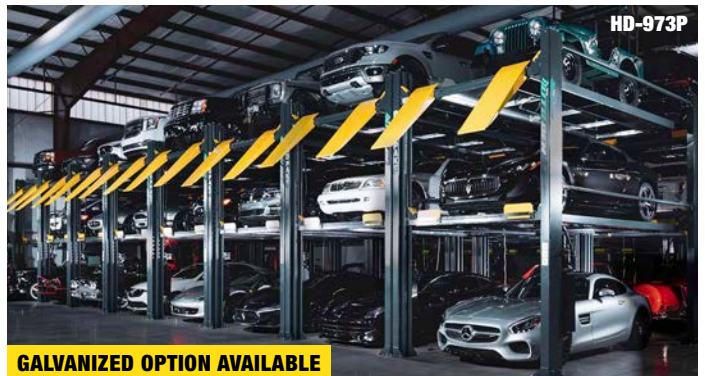

HD-973P

GALVANIZED OPTION AVAILABLE

Variability in Specifications and Features: All product specifications and features listed in this catalog are for reference only. For a more accurate and comprehensive listing of product specifications and features, visit www.bendpak.com. The contents of this catalog are subject to change.

AUTOSTACKER

Double Your Parking

A6S
#5175274



- Galvanized Deck
- Tire Stop
- Low-Profile Entry Ramp
- Patented Door-Sentry™ Car Door Protectors
- 6 Locking Positions
- Tandem Direct-Drive Cylinders
- Synchronized Flow Control
- Automatic Safety Locks

 **See it on YouTube**

POWER REQUIREMENTS

Standard - Power Unit Console (Single unit operation)

- Motor Voltage: 208-240 VAC / 50/60Hz / 1Ph
- Power Consumption: 1,500 Watts
- Motor Horsepower: 2 HP
- Starting Amps: 25A
- Normal Running Amps: 12-18A

Optional multi-unit power unit console (Operates up to 14 lifts)

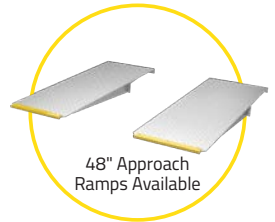

48" Approach Ramps Available

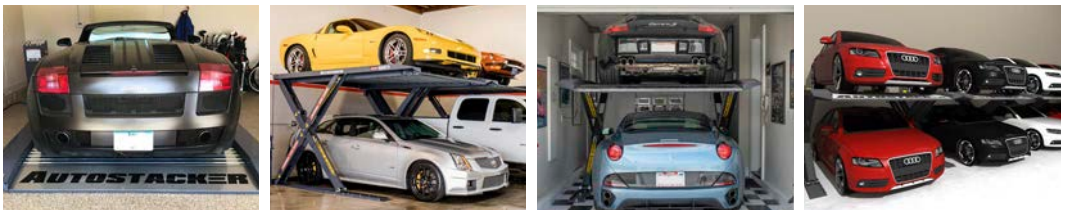

Multi-Platform Parking Lift

Multi-Platform Parking Lift Features

- 6,000-lb. capacity per deck
- Perfect for cars, light trucks and ATVs
- Rugged I-beam and C-channel construction
- Wide base plate for maximum stability
- Superstructure features durable powder coat finish
- Dual hydraulic cylinders with heavy-duty steel lifting cable
- Heavy-duty steel construction
- Reliable electric-hydraulic power system
- Features heavy-duty 3/8" aircraft cable
- Rugged 1-1/4" roller axes
- Simple controls
- Full-width platform to keep bottom vehicles protected

**PL-6KT
Triple Deck
Platform Lift**
#5175154



- Lifting Capacity / Deck - 6,000 lbs.
- Overall Width - 308"
- Overall Length - 236.5"
- Platform Width - 82"
- Length of Platforms - 152"
- Drive Clearance - 93"
- Max. Lift Height - 89"

**URNS A THREE-CAR GARAGE
INTO A SIX-CAR POWERHOUSE**



Variability in Specifications and Features: All product specifications and features listed in this catalog are for reference only. For a more accurate and comprehensive listing of product specifications and features, visit www.bendpak.com. The contents of this catalog are subject to change.

- High-speed lifting
- Oversized sheave diameter reduces cable fatigue
- Multi-position safety locks in each column
- Runways feature non-skid surface
- Independent backup slack-cable safety latches
- Built-in wheel stops



PL-1200DPS
Shortened Length
Tandem Parking Lift

#5175552

- Lifting Capacity Per Platform - 6,000 lbs.
- Overall Width - 221.5"
- Overall Length - 218.5"
- Length of Runway - 159"
- Drive Clearance - 68.5"
- Max. Lift Height - 70.2"

PL-1200DP
Tandem Parking Lift

#5175547

- Lifting Capacity Per Platform - 6,000 lbs.
- Overall Width - 221.5"
- Overall Length - 242.5"
- Length of Runway - 183"
- Drive Clearance - 80.5"
- Max. Lift Height - 82"



**SEE IT IN
ACTION**



POWER YOUR ADVENTURES

JACKPAK[®]
ULTRA2500A

**MEGA
2500 AMPS
OF POWER!**

**THE PERFECT
ROADSIDE HELP**

**LITHIUM-ION
POWER TECHNOLOGY**



Up To

6.5L

Diesel Engines

Up To

8.5L

Gas Engines

USB-C / USB-A



The Original and Still The Best.

THE PERFECT ROADSIDE HELP



JUMP STARTER
2500A



AIR INFLATOR
150PSI



LED FLASHLIGHT
300 Lumen



POWER BANK
22,800mAh

SPECIFICATIONS:

- Battery Capacity: 76Wh
- Starting Voltage: 12V
- Current: 1200A - 2500A
- Pressure Range: 10 - 150 psi
- Battery Life: 1000 Cycles
- Charging Time: 4.5 - 8 Hours

FEATURES:

- Built-In Air Compressor
- 5V USB Outlet for Small Electronic Devices
- LED Flashlight/ Emergency Signal
- Lightweight & Compact Design
- Fits Under Seat or Glove Compartment

INCLUDES:

- Jumper Cable Attachment
- Air Hose w/ Heavy-Duty Nylon Abrasion Sheathing
- USB-A to USB-C Cable
- Nozzle Adapters
- Carrying Case



Check Out the Full
JACKPAK Line-up!



SKU #5180050

©2024 JackPak™. A division of BendPak Inc.

JACKPAK®

MEET THE NEW JACKPAK LINEUP

JackPak's all-new selection of portable power packs deliver a reliable source of power whenever you need it the most. With a wide variety of power packs to choose from including jump starters, solar panels, emergency radios, and power stations to name a few, you'll have the versatility you need to power up how you'd like. Shop and learn more at www.jackpak.com



PS600W

- LCD Display
- Water-Resistant
- Charge Port
- LED Lamp Button

PORTABLE POWER STATION

This versatile Power Station is perfect for long trips. It can be used to charge a wide range of devices charged like phones, tablets, lamps, drones, and more. Pair it with an SP100W to get hours of uninterrupted operation.



PB960

- Pass Through Charging
- LED Display
- 2 USB Ports
- Cigar Lighter Socket

PORTABLE POWER BANK

Charge multiple devices at once with this high-capacity power bank! The PB960 is perfect for your next camping trip! It features an IP64 rating and sports 2 USB ports. The Wireless Charging Area keeps newer devices taken care of.



SP100W

- Flexible and Foldable
- Compatible with Most Power Stations
- Built-in Kickstand
- Layered Design

PORTABLE SOLAR PANEL CHARGER

The SP100W is a solar panel charger which has a sleek design, is portable and foldable, and can go with you anywhere. The 5-layered design provides protection, and the monocrystalline cells deliver power even in low solar intensive areas!



PB20KS

- Two USB Ports
- Wireless Charging
- Water Resistant
- Over-Charge Protection

SOLAR POWER BANK

A pocket size multiple solar panel charger for your handheld devices. Keep your mobile devices going when outdoors. You can use a USB to connect through Micro-USB or the Type-C connector which is found under the rubber end cover.



RL400

- Four Power Supply Modes
- Rechargeable Battery Pack
- Weather Alert
- AUX Music Player

MULTI-FUNCTION HAND CRANK EMERGENCY RADIO

The RL400 is an AM/FM radio, weather alert, flashlight, SOS alarm, and music player; all in one device. It can even charge your phone. There are 4 ways to charge the RL400, with two eco-friendly options: the hand crank dynamo and solar panels!

1-833-522-5725

www.jackpak.com

© 2024 JackPak™, LLC. A division of BendPak Inc. All rights reserved.

Pipe Benders

SERIES FEATURES:

- 3-1/3" min. bending radius
- 5" max. bending radius
- Canister style hydraulic filter
- 5 Hp / 208 - 230 VAC motor
- Manual or automatic controls
- Drop-in swaging collars
- Twist lock tooling
- ANSI 92.2 Cylinders
- Quick release bending dies
- Bending heads to within .002"
- Bending and end finishing operation
- Adjustable back gate pressure
- 180° bending capacity
- One piece solid steel barrel
- Direct drive high speed 4 GPM pump
- Tool trays
- Large fluid reservoir
- Filtered hydraulic system
- Oil sight gauges
- 1/2" high pressure hose
- Wide variety of tooling available

BB-2-DLX-601 #5115150



Bending Controls - Manual
Clampless Swager - Internal Expander
Deluxe 302 Tooling Package

1302BAS-DLX-601 #5115180



Bending Controls - Semi-Automatic
Clampless Swager - Internal Expander
Deluxe 302 Tooling Package

1302BA-DLX-601 #5115121



Bending Controls - Digital Automatic
Clampless Swager - Internal Expander
Deluxe 302 Tooling Package

BB-2-MET-503 #5115120
BB-2-MET-601 #5115122



Bending Controls - Manual
Clampless Swager - Internal Expander
Deluxe Metric Tooling Package

1302BAS-MET-503 #5115123
1302BAS-MET-601 #5115124



Bending Controls - Semi-Automatic
Clampless Swager - Internal Expander
Deluxe Metric Tooling Package

1302BA-MET-503 #5115126
1302BA-MET-601 #5115127



Bending Controls - Digital Automatic
Clampless Swager - Internal Expander
Deluxe Metric Tooling Package

300-1 Die Package

#5105570



6-Piece Set
Bends 3" OD Tubing



Air Compressors

SERIES FEATURES:

- 80 & 120 Gallon vertical tank
- 2-stage pump
- ASME rated tank
- Electric mag-starter
- Fan-type flywheel
- Fully enclosed belt guard
- Tapered roller bearings
- Forged ductile iron crankshaft
- Corrosion resistant tubing for coolers, separators and valves.
- 100% cast iron Elite pump
- Cast iron cylinders and heads with deep cooling fins
- Forced-air after cooler
- Oil sight gauge
- Automatic pressure switch
- ASME rated overload pressure safety valve
- Pressure gauge with valve
- Oversized replaceable air filters
- Automatic start / stop

5 HP MODEL

TSP-580V-601
#5179111



Voltage - 208-230 V / 60 Hz / 1 Ph
Horsepower - 5 Hp
Maximum CFM - 17 / 175 psi
Tank - 300L / 80 Gal / Vertical

7.5 HP MODEL

VMP-7580V-601
#5179112



Voltage - 208-230 V / 60 Hz / 1 Ph
Horsepower - 7.5 Hp
Maximum CFM - 26 / 175 psi
Tank - 300L / 80 Gal / Vertical

10 HP MODEL

VMP-10120V-603
#5179114



Voltage - 208-230 V / 60 Hz / 3 Ph
Horsepower - 10 Hp
Maximum CFM - 35 / 175 psi
Tank - 454L / 120 Gal / Vertical

ANSI

Extreme-duty four-cylinder cast iron pump

Protective pulley cover

Electric motor with cooling fan

Air cooling assembly

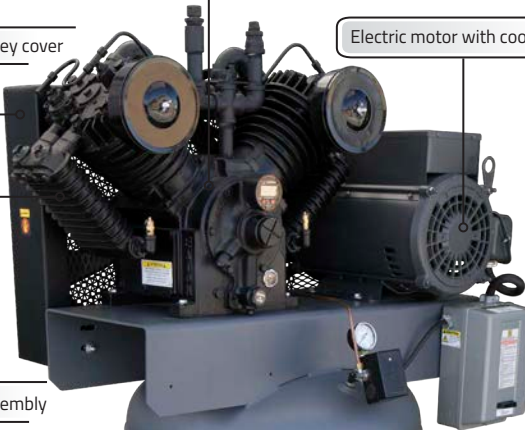

PATRIOT SERIES

PROUDLY MADE IN THE USA

When a tough application calls for rugged dependability, count on BendPak Patriot Series™ air compressors to work as hard as you do. We make all of our compressors in an ISO 9001-registered manufacturing facility in Clayton Ohio, where we ensure that every compressor delivers the durability and performance you expect. Our highly efficient Patriot Series air compressors feature rugged, low-rpm 100% cast-iron pumps, ASME tanks, copper piping for cooler operation and American made motors and starter. Made in America also means that they're backed by one of the most comprehensive warranties in the industry.

Ranger® Tire Changers

GET MORE - SPEED - HORSEPOWER - TORQUE

Modern tires are *more* stubborn than ever. If you want to get the job done quickly and correctly than you need a tire changer that has **more**. Equipped with 220VAC, Ranger's latest tire changers deliver more of everything. With more speed, more horsepower and gobs more torque, you can break beads and swap tires on even the most difficult tires in your shop. Plus the powerful, high-torque electric turntables, increased speed and reversible direction mean quicker tire removal and installation, giving you more bang for your buck. Important accessories come standard, like a multi-piece plastic wheel protector kit that includes turntable jaw covers, bead-breaker blade boots and specialized mount/demount head covers to help protect delicate wheels. With all of the reliable features that Ranger tire changers are known for, and now even **more power**, why settle for less?

R745 Swing Tire Chl

#5140148

VOLTAGE
110VAC
OR
220VAC

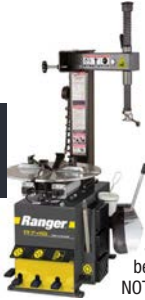

NOTE:
Jet blast
bead seater
NOT INCLUDED

Internal Clamping - 12" - 20"
External Clamping - 10" - 16"
Maximum Tire Diameter - 36"

R76LT Tilt-Back Tire Changer

#5140144



Internal Clamping - 10" - 30"
External Clamping - 8" - 26"
Maximum Tire Diameter - 43"

R980XR Swing-Arm Tire Changer

#5140146



Internal Clamping - 10" - 30"
External Clamping - 8" - 26"
Maximum Tire Diameter - 50"

R980AT Swing-Arm Power Assist

#5140147



Internal Clamping - 10" - 30"
External Clamping - 8" - 26"
Maximum Tire Diameter - 50"

R76ATR Tilt-Back Power Assist

#5140140



Internal Clamping - 10" - 30"
External Clamping - 8" - 26"
Maximum Tire Diameter - 43"

R80EX Dual-Assist Tilt-Back Tire Changer

#5140139



Internal Clamping - 13" - 34"
External Clamping - 10" - 30"
Maximum Tire Diameter - 47"

R26FLT Super-Duty Truck Tire Changer

#5140137



Drive System - Electric / Hydraulic
Maximum Rim Diameter - 14" - 26"
Maximum Tire Diameter - 63"

RimGuard™ Wheel Clamps



Variability in Specifications and Features: All product specifications and features listed in this catalog are for reference only. For a more accurate and comprehensive listing of product specifications and features, visit www.bendpak.com. The contents of this catalog are subject to change.

ACCESSORIES:



Plastic Duckhead
#5150523



ATV / Motorcycle Duckhead
#5327457



RimGuard™ Wheel Clamps
#5328311



Elevating Clamps
#5328425



RWL-150T Wheel Lift
#5150355

R80EX Dual-Assist Tilt-Back Tire Changer

#5140139



**ALL RANGER TIRE
CHANGERS FEATURE:**
Polymer & Urethane
RimGuard™ Wheel Clamps
(Excludes R745)

Ranger® Wheel Balancers

DST-2420 FEATURES:

- Dynamic, Static and Performance Alloy settings
- Automatic round-off with top-dead-center weight position indicator
- Hardened-steel 36 mm shaft
- Quick-release hub nut
- Multi-user save function

DST30P FEATURES:

- Ergonomic control board and easy-to-read LED display
- Multi-user save function
- Automatic braking
- Low RPM balancing speed and rapid six-second cycle time
- Self-calibration function

RB24T

- Integrated power phase converter
- Top positioning weight locator
- Inside & outside measuring
- Millimeter / inches selection
- Ounce / gram selection
- Self-calibration function

DST-2420 Wheel Balancer

#5140156



DUAL VOLTAGE
110V / 220V

Max. Wheel Diameter - 10" - 30"
Max. Tire Diameter - 47"
Max. Tire Weight - 145 lbs.

DST30P Wheel Balancer

#5140154



DUAL VOLTAGE
110V / 220V

Max. Wheel Diameter - 8" - 30"
Max. Tire Diameter - 50"
Max. Tire Weight - 150 lbs.

RB24T Truck Wheel Balancer

#5140149



VOLTAGE
380VAC

Max. Wheel Diameter - 30"
Max. Tire Diameter - 50"
Max. Tire Weight - 400 lbs.

YOUR ULTIMATE ONE STOP TIRE SHOP

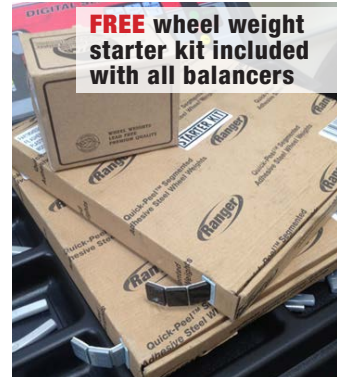

Truck Cone Kit

#5150032



Double-sided centering cone fits hub sizes 4.75" - 6.75"

Motorcycle Shaft Kit

#5150030



Fits DST-2420 and DST-64T
Includes: Universal wheel clamp, shaft, centering cones, spacers and spin-on nut

Lug Bolt Kit

#5150020



8-pc. kit
Includes: Centering pin adapters, flange plate kit and measuring caliper

Wheel Balancers Features & Specifications

Laser-Spot Balancer

INFORMATION:

The Ranger LS43B wheel balancer handles wheels up to 43 inches in diameter. The average cycle time is just 7 seconds, making it one of the fastest and most reliable balancing machines ever built. Top-of-the-line technology and features take all of the guesswork and human error out of wheel balancing. The standout feature on this model, of course, is Ranger's exclusive 3D Quick-Touch™ Laser-Spot™ technology. Using this feature the LS43B highlights the pinpoint location at which operators should place the minimal amount of weight in order to achieve a perfect balance at the 6 o'clock position.

LS43B FEATURES:

- Dynamic, Static and Performance Alloy settings
- Manual or automatic start
- Automatic braking
- Low RPM balancing speed and rapid six-second cycle time
- Self-calibration function

LS43B Wheel Balancer 3D Quick-Touch™ Laser-Spot™

#5140151

Max. Wheel Diameter - 10" - 30"
Max. Tire Diameter - 47"
Max. Tire Weight - 145 lbs.
Wheel Width Cpty. - 2" - 18"
Balancing Speed - 180 RPM

Includes FREE Wheel
Weight Starter Kit

INCLUDES TOOLING KIT



OPTIONAL Clip-On Steel Wheel Weights

Sold separately



25 ea.

0.25oz, 0.50oz, 0.75oz, 1oz, 1.25oz, 1.5oz,
1.75oz, 2oz, 2.25oz, 2.5oz, 2.75oz, 3oz

LED Wheel Weight Displays

DataWand™ for Automatic
Wheel Data Entry

User-Friendly Operation

Laser-Spot™ Technology



Ranger® Brake Lathes

RL-8500XLT FEATURES:

- Extended capacity spindle can be used on brake drums 10" deep
- Rear bushing location provides extra support for the arbor
- Capable of truing even the heaviest drum rotors
- Optional truck adapter kit available
- Simple ergonomic controls designed for minimal operator movement
- Precision electric DC servo motors designed to meet the demanding requirements of industrial motion control
- Quick-Change Adapter-Plus system
- Works on all cars or trucks, both foreign and domestic, with hubless drums, rotors (center hole sized 2-5/32" – 4") and composite rotors (center hole sized 4" – 6.25")
- Precision twin cutter tools and a quick drum-to-rotor changeover

RL-8500XLT Combination Brake Lathe Package Super-Duty

#5150080



Max. Rotor Thickness - 2.5"
Max. Rotor Diameter - 17"
Max. Drum Diameter - 28"

Light & Medium Truck Adapter Set

#5150171



A) Small Truck Cone - 4.125" x 5.25"
B) Large Truck Cone - 5.125" x 6.25"
C) Truck Plate - 7.40" OD

Brake Lathe Truck Adapter Kit

#5150161



Fully Equipped Multi-Piece Set
Accommodates Medium & Full Size Trucks

RL-8500 Combination Brake Lathe Package

#5150066

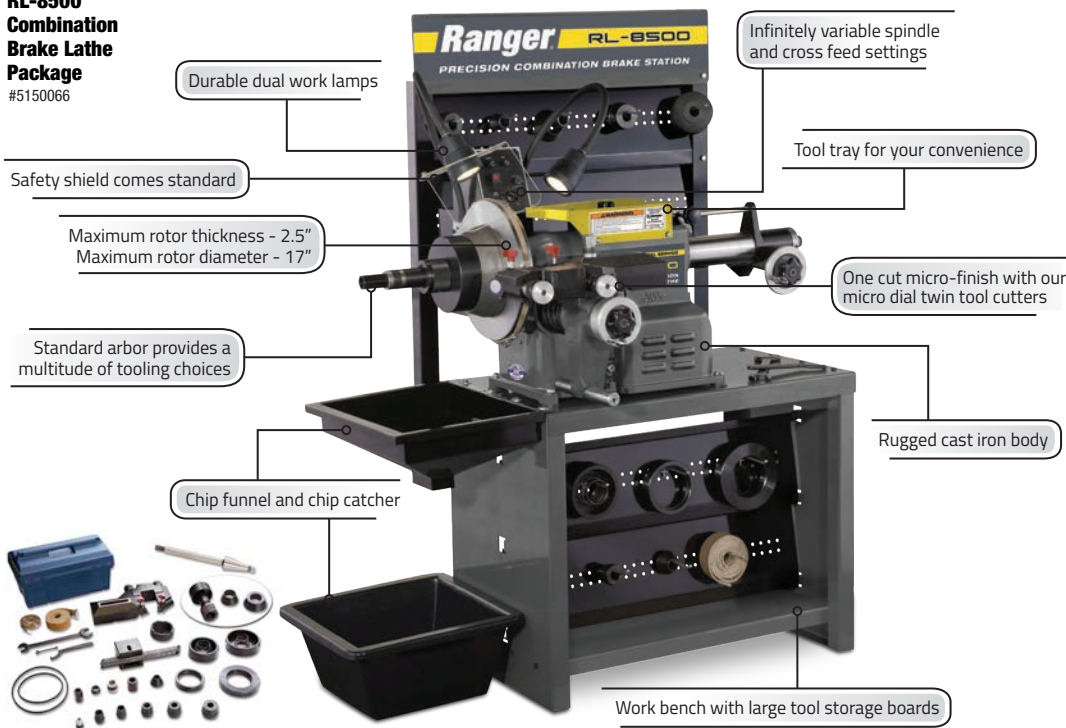

Durable dual work lamps

Infinitely variable spindle and cross feed settings

Safety shield comes standard

Tool tray for your convenience

Maximum rotor thickness - 2.5"
Maximum rotor diameter - 17"

One cut micro-finish with our micro dial twin tool cutters

Standard arbor provides a multitude of tooling choices

Rugged cast iron body

Chip funnel and chip catcher

Work bench with large tool storage boards

Fully equipped tool package comes standard

See it on the BendPak / Ranger YouTube Page



Power Units

Power Units Explained

Ranger™ AC hydraulic power units are self-contained, dependable sources of hydraulic power that come standard with an abundance of features and benefits in a durable and economic package. These high-quality power units are ideal for industrial AC applications, such as auto lifts, elevated work platforms, scissor lifts, dock levelers, conveyors, packaging machines, machine tools, compactors, crimping machines, presses, robotic equipment, tailgate lifts, dump bodies, cab tilts, emergency backup units, snowplows, log-splitters, harvesting machinery, lift platforms, scaffolds, presses, waste compactors, car lifts, medical and dental field lifts and more.

E1.2B3F1 Power Unit

#5585435



Gal Reservoir - 1.6 / PRV - 2500
Motor - 1.5 HP / 220V - 60 Hz -1PH
CE Listed

E2.1F3H1 Power Unit

#5585285



Gal Reservoir - 3.6 / PRV - 2650
Motor - 2.5 HP / 208-230V-50/60 Hz-1PH
UL/ETL Listed

F2.1F3H1 Power Unit

#5585280



Gal Reservoir - 3.6 / PRV - 2850
Motor - 2.5 HP / 208-230V-60 Hz-1PH
UL/ETL Listed

FEATURES:

- UL / ETL Listed (except model E1.2B8F1)
- Vertical Design
- Built-in throttle and buffer valves reduce pre-load pressure
- Integrated fixed-setting pressure relief valve
- Submerged pump
- Spare pressure port
- Multi-hole adapter plate adapts to a wide variety of mounting applications
- Suction-strainer
- Breather and fill-cap



NEED REPLACEMENT PARTS? WE HAVE THEM TOO.
CALL US TOLL FREE 1-800-253-2363

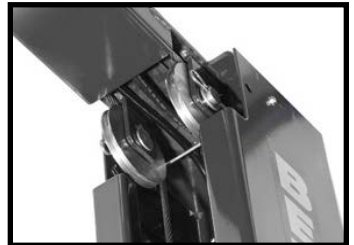

Ranger® Jacks & Lifting

INFORMATION:

Ranger's wide array of multi-purpose floor jacks just keeps getting larger and more diverse. Our floor jacks have maximum capacities ranging from 3,000 to 60,000 lbs. and come in a variety of styles, like quick-pump and low-profile. No matter which one you choose, Ranger floor jacks offer incredible lifting power and top-notch construction that you can count on to never let you down. Our impressive line of floor jacks are carefully designed to accommodate a wide spectrum of weight capacities and lifting applications, easily lifting just about anything that needs service.

RFJ-3000AL 1.5 Ton Aluminum Racing Floor Jack

#5150061



Capacity - 3,000 lbs.
Height - 3.5" - 17.5"
Chassis Length - 24"

RFJ-3000LPF 1.5 Ton Super-Long Floor Jack

#5150060

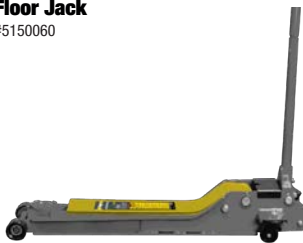

Capacity - 3,000 lbs.
Height - 2.75" - 24"
Chassis Length - 34"

RFJ-4000AL 2 Ton Aluminum Racing Floor Jack

#5150085



Capacity - 4,000 lbs.
Height - 3.5" - 17.75"
Chassis Length - 24"

RFJ-5000HD 2.5 Ton Heavy-Duty Commercial Grade Floor Jack

#5150056



Capacity - 5,000 lbs.
Height - 3" - 20"
Chassis Length - 26"

RFJ-3TP 3 Ton Professional Floor Jack

#5150440



Capacity - 6,000 lbs.
Height - 5.25" - 19.25"
Chassis Length - 26"



RFJ-3000LPF

RFJ-3T 3 Ton Racing Style Floor Jack / Plunger-U-Joint

#5150414



Capacity - 6,000 lbs.
Height - 4.75" - 20.5"
Chassis Length - 28"

RFJ-3TQP 3 Ton Quick-Pump Floor Jack

#5150418



Capacity - 6,000 lbs.
Height - 5" - 19.75"
Chassis Length - 25.5"

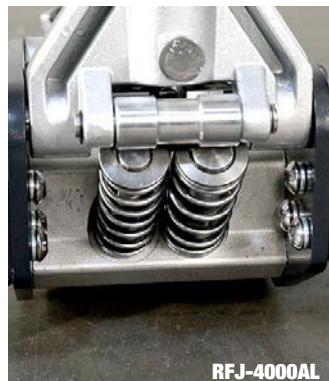

RFJ-4000AL

Variability in Specifications and Features: All product specifications and features listed in this catalog are for reference only. For a more accurate and comprehensive listing of product specifications and features, visit www.bendpak.com. The contents of this catalog are subject to change.

GALLERY:



**RFJ-6HD
3 Ton "Low Rider"
Floor Jack**

#5150446



Capacity - 6,000 lbs.
Height - 3.625" - 21"
Chassis Length - 27"

**RFJ-10TL
10 Ton Long Frame
Floor Jack**

#5150434



Capacity - 20,000 lbs.
Height - 7" - 23"
Chassis Length - 61"

**RBJ-30TL
30 Ton Telescoping
Air Bottle Jack**

#5150443



Capacity 1st Stage - 60,000 lbs.
Capacity 2nd Stage - 30,000 lbs.
Height - 6.5" - 12" / Chassis Length - 22.5"

**RTJ-1100
1/2 Ton
Transmission
Jack**

#5150442



Capacity - 1,100 lbs.
Height - 45" - 72"
Base - 24" x 24"

**RTJ-1
1 Ton
Transmission
Jack**

#5150404



Capacity 1st Stage - 2,000 lbs.
Capacity 2nd Stage - 1,000 lbs.
Height - 37" - 73" / Base - 39" x 39"

**RTJ-3000
1.5 Ton
Transmission
Jack**

#5150406



Capacity 1st Stage - 3,000 lbs.
Capacity 2nd Stage - 2,000 lbs.
Height - 35.5" - 71.5" / Base - 34" x 34"



RFJ-4000AL

Ranger® Jacks & Lifting

SERIES FEATURES:

- Welded steel construction for maximum durability
- Safety ratchet design ensures stands remain locked under load
- Perfect for holding drivetrain or exhaust components in position
- Sold in pairs
- Quick-adjust spin handle with thrust bearing
- Wide base provides maximum stability
- Thick, rubber adjustable pad for maximum support
- Convenient handle and column release
- Hardened ACME screw for easy adjustment
- Tripod design evenly distributes weight
- Pneumatically operated wheel lift
- One-handed lever control
- Heavy-duty steel casters
- Bearing mounted slider
- Stabilizes vehicles raised on lifts
- Heavy-steel construction for maximum durability

RJS-3T 3 Ton Jack Stands (Set of 2)

#5150115



Holding Capacity - 6,000 lbs.
Height - 11.5" - 17"
Base Dimensions - 7" x 7.5"

RJS-6T 6 Ton Jack Stands (Set of 2)

#5150120



Holding Capacity - 12,000 lbs.
Height - 15.5" - 24.5"
Base Dimensions - 9" x 10.5"



RJS-3T

RJS-1T High Reach Jack Stand

#5150183



Holding Capacity - 1,650 lbs.
Height - 54.5" - 80.5"
Base Dimensions - 12" Diameter

RJS-1TF High Reach Jack Stand Foot Operated

#5150185



Holding Capacity - 1,650 lbs.
Height - 54.5" - 80.5"
Base Dimensions - 12" Diameter

RJS-2TH Tripod Jack Stand

#5150125



Holding Capacity - 4,000 lbs.
Height - 55" - 87"
Base Dimensions - 24" x 24"

MLS-18 Mobile Jack Stand

#5175001



Holding Capacity - 18,000 lbs.
Height - 48.75" - 74.5"
Base Diameter - 32"

RWL-150T Pneumatic Wheel Lift

#5150355



Fits R980XR & R980AT

Lifting Capacity - 150 lbs.
Pneumatic Operation
Welded Steel Construction



RWL-150T

Lifting Features & Specifications

Ranger® Motorcycle Lifts

SERIES FEATURES:

- Constructed out of 12-gauge steel
- Pneumatic lifting cylinder
- Durable powder coat finish
- Adjustable front wheel vise
- Drop-away rear wheel deck
- Easy ramp(s) removal
- Front and side extensions standard
- Built-in retractable swivel casters
- Full travel automatic safety locks
- Single hydraulic lifting cylinder
- Side decks can be easily removed
- Diamond-plate approach ramps
- Air powered hydraulic pump operation
- Multiple locking positions



**RML-1500XL
Extended
Motorcycle
Lift**
#5150605



Lifting Capacity - 1,500 lbs.
Height - 7.75" - 45" / Table Width - 29.5" - 51"
Table Length - 79.5" - 99.75"

**RML-1100
Motorcycle Jack**
#5150071



Lifting Capacity - 1,100 lbs.
Height - 3.5" - 16"
Top Dimensions - 6" - 17.75"

RML-1500XL

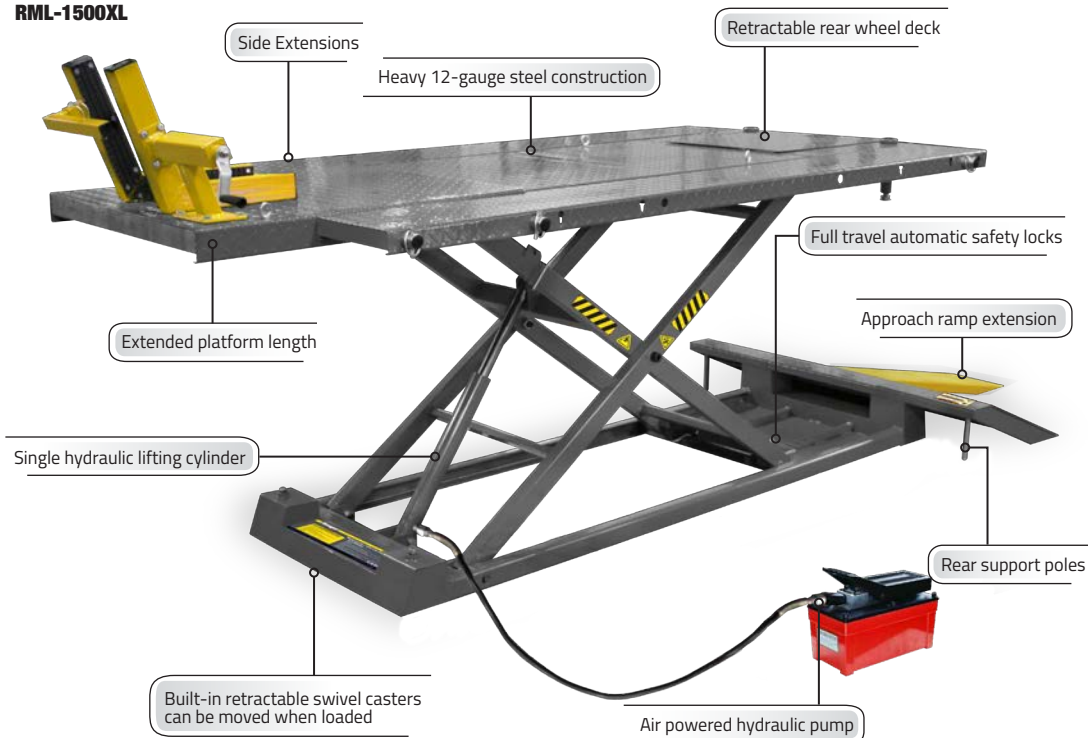

Ranger® Shop Equipment

INFORMATION:

Let Ranger Products lighten the load with our considerable line of high-quality rolling equipment. All Ranger Carts and Dollies are made from high-gauge steel and employ only the best casters for easy maneuvering. Our service carts, chassis-mount vehicle dollies, low-profile automobile carts and rolling adjustable work tables come fully equipped to make your day in the garage infinitely easier. Don't lift or carry—roll with Ranger!

Ranger's industrial shop presses offer you the versatility of professional-grade hydraulic force, whether you're at the shop or in your own garage. Among other operations, all Ranger Hydraulic Presses are ideal for the removal and installation of gears, bushings and bearings—so you can bend, straighten, flatten, crush, press, shape, push, pull, lift and spread like you were born doing it.

RCD-1TD Wheel Dolly Auto Carts

#5150190



Capacity - 1,000 lbs. (Each)
Dimensions - 15.5" x 23.5"
3.5" Cast Iron Ball Bearing Casters

RCD-2V 4,400-lb. Capacity Vehicle Dolly

#5150409



Lifting Capacity - 4,400 lbs. (Each)
Overall Height - 10"
Caster Size - 4.5"

RP-20T Bottle Jack Shop Press

#5150496



Capacity - 40,000 lbs.
Cylinder Stroke - 8"
Width - 23" / Height - 59"

RCD-1500 GoCart™ Vehicle Dolly

#5150595



(Sold as Pair)

Load Rating Each - 1,500 lbs.
Tire Width Capacity - 12"
Tire Diameter Capacity - 15" - 28"

RCD-1500EX GoCart™ Vehicle Dolly Extended

#5150191

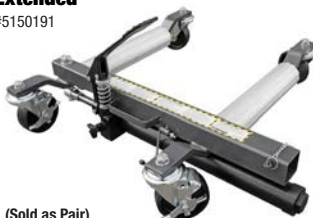

(Sold as Pair)

Load Rating Each - 1,500 lbs.
Tire Width Capacity - 13"
Tire Diameter Capacity - 19" - 37"

RP-20HD Hydraulic Shop Press

#5150059



Capacity - 40,000 lbs.
Cylinder Stroke - 5.5"
Width - 37" / Height - 60.25"

GoCart™ Storage Rack

#5150600



Load Rating - 200 lbs.
Dimensions - 19" x 31" x 9"
Holds up to 4 GoCart™ Dollies

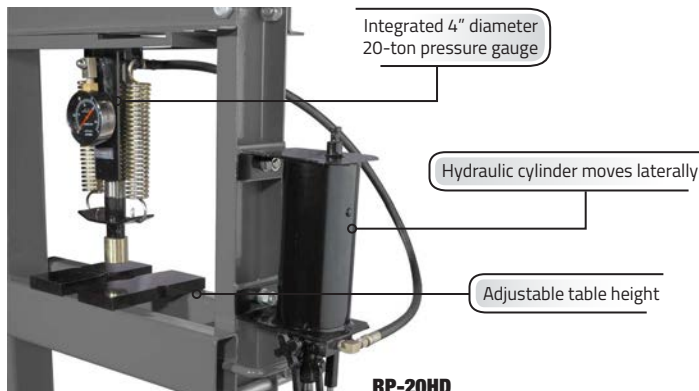

Integrated 4" diameter
20-ton pressure gauge

Hydraulic cylinder moves laterally

Adjustable table height

RP-20HD

Variability in Specifications and Features: All product specifications and features listed in this catalog are for reference only. For a more accurate and comprehensive listing of product specifications and features, visit www.bendpak.com. The contents of this catalog are subject to change.

RWB-2D FEATURES:

- Electrostatic triple-baked protective powder coat
- Rolled edges for added strength and rigidity
- Full-extension ball bearing drawer slides
- Tumbler key-lock pivot drawer latching system

RWB-2S FEATURES:

- Glossy red finish
- Electrostatic oven-baked powder coat
- Rolled edges for added strength and rigidity
- 5/32" HD rolled edge steel table top
- 3/32" HD rolled edge steel shelves
- 12-gauge construction

RWB-1TD FEATURES:

- Lockable heavy-duty drawer
- 500-lb. working capacity
- Heavy-duty 4" casters
- Adjustable working height
- Removable polyethylene fluid drain
- 14-gauge table top
- 3/4" liquid containing rim

RWB-2D
2-Drawer Work Bench
#5145330



Height - 34.5"
Width - 59"
Depth - 25.25"

RWB-2S
2-Shelf Work Bench
#5145335



Height - 34.5"
Width - 79"
Depth - 25.25"

RWB-1TD
Work Bench w/Fluid Catcher
#5145336



Height - 40"
Width - 48"
Depth - 32"

RH-50PL
Hose Reel
#5150211

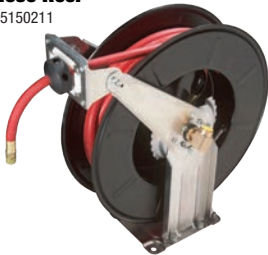

Air Pressure - 300 psi
Hose Length - 50'
Fittings - 3/8"

Anti-lock out ratchet mechanism prevents reel from locking up when hose is fully extended

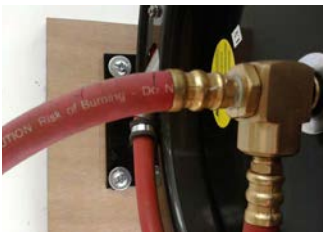

RH-50PL

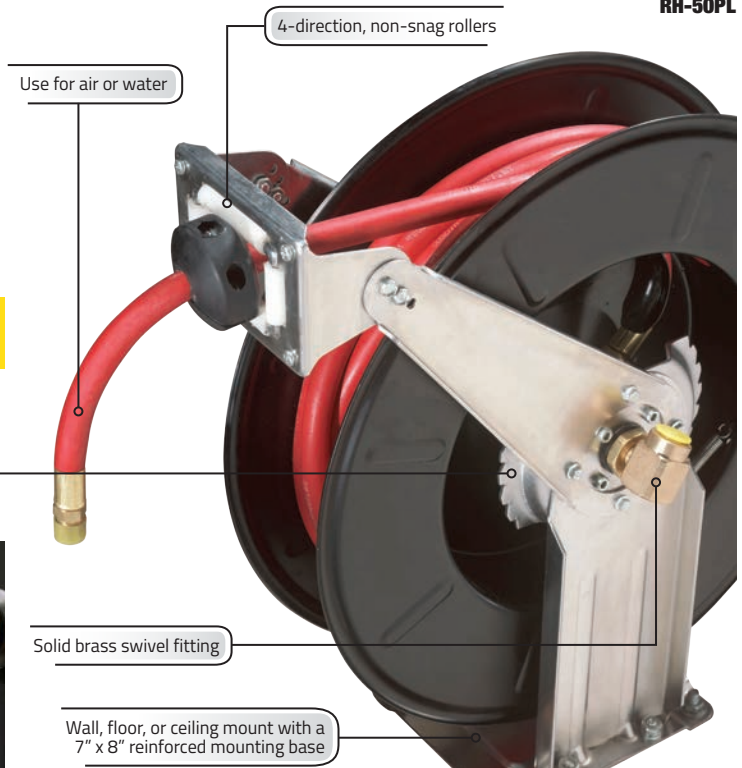

Ranger® Shop Equipment

SERIES FEATURES:

Oil Drains

- Lightweight for easy portability
- Safe and easy to use
- Non-corrosive telescoping tube
- Heavy-duty stainless steel clamp
- Built-in hand grips
- Durable steel construction
- Tough construction will resist dents, rust, and corrosion
- Rugged funnel with built-in contamination screen

Oil Filter Crushers

- Reduces cans up to 20%
- Reduces filters up to 25%
- Crushes cans in only 15 seconds
- Hydraulic powered (20FC air operated)
- Fulfills EPA and other mandated environmental standards
- Removes up to 95% of the oil
- Compact floor or bench-mount design
- All-steel industrial construction

RD-9G 9-Gallon Oil Drain

#5150997



Capacity - 9 gal.
Height - 32" - 64"
Funnel Diameter - 18"

RD-18G 18-Gallon Oil Drain with Pump

#5150995



Capacity - 18 gal.
Height - 56" - 72"
Evacuation Pump

RD-15 15-Gallon Low-Profile Oil Drain

#5150206



Capacity - 15 gal.
Height - 8.5"
Shipping Weight - 43 lbs.

RD-20SE 20-Gallon Air-Evac Oil Drain

#5150996



Capacity - 20 gal.
Height - 52" - 83"
Funnel Diameter - 16"

RP-20FC Oil Filter Crusher with Stand

#5150067



(Barrel not included)

Capacity - 10 Ton / Cycle Time - 15 - 20 sec.
Air Requirements - 125 - 175 psi
Dimensions - 29.5" x 17" x 17"

RP-30FCH Electric / Hydraulic Oil Filter Crusher with Stand

#5150008



Capacity - 15 Ton / Cycle Time - 8 - 15 sec.
Power Supply - 208-240V / 50/60Hz / 1 Ph
Dimensions - 75" x 42.5" x 17"

RP-50FC Heavy-Duty Oil Filter Crusher with Stand

#5150401



(Barrel not included)

Capacity - 25 Ton / Cycle Time - 8 - 15 sec.
Power Supply - 208-240V / 50/60Hz / 1 Ph
Dimensions - 90.5" x 32.5" x 31.5"



ITEM COLOR MAY VARY



See it on
Youtube

Variability in Specifications and Features: All product specifications and features listed in this catalog are for reference only. For a more accurate and comprehensive listing of product specifications and features, visit www.bendpak.com. The contents of this catalog are subject to change.

RS-500D / RS-750D FEATURES:

- Heavy-duty steel construction
- Removable tank screen
- Stainless oil skimmer
- Removable parts tree
- Powder coat finish
- Brass nozzles
- Full opening octagonal door
- Large drain pipe
- Heavy-duty rubber casters
- Friction-drive turntable system
- Gasket-free door
- Small parts basket
- Stainless steel handles
- FREE bucket of soap included

SOAP FEATURES:

- Non-foaming soap
- Low pH
- Mild alkali
- Water soluble
- Specially formulated
- Removes grease, oil, stains, carbon, protein and some paints

RS-500D Spray Wash Cabinet

#5155117

FREE 20-lb.
Soap Bucket



Load Capacity - 500 lbs.
Tank Capacity - 50 gal.
Interior Dimensions - 43" x 32"

RS-750D Spray Wash Cabinet (Truck)

#5155118

FREE 20-lb.
Soap Bucket



Load Capacity - 1,000 lbs.
Tank Capacity - 53 gal.
Interior Dimensions - 32" x 54"

Aluma-Klean Detergent

20 lbs. #5155096

50 lbs. #5155100



Low pH
Water soluble
Non foaming soap

STAINLESS STEEL OPTION AVAILABLE

RS-500DS Stainless Steel Spray Wash Cabinet

#5155051

RS-750DS Stainless Steel Spray Wash Cabinet

#5155052

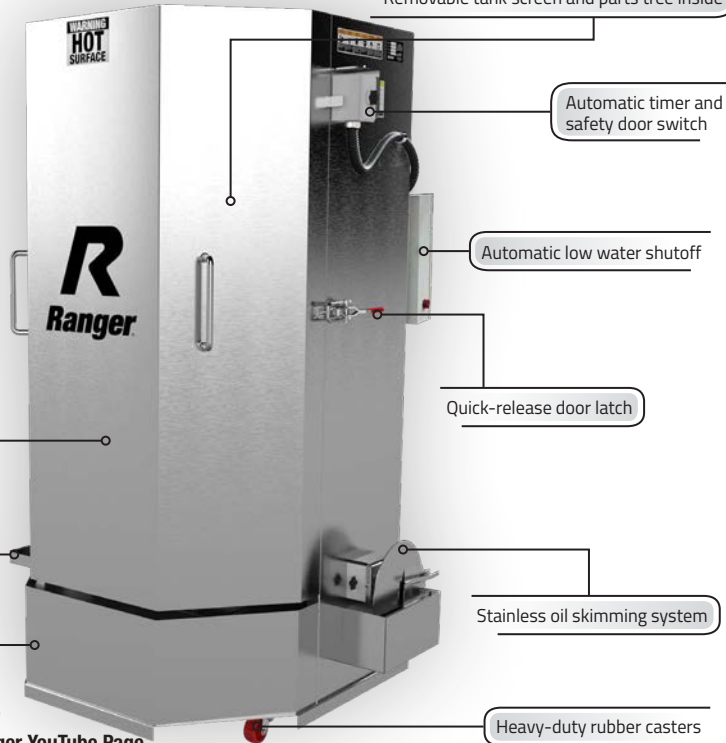

Removable tank screen and parts tree inside

Automatic timer and safety door switch

Automatic low water shutoff

Quick-release door latch

Stainless oil skimming system

Heavy-duty rubber casters

Friction-drive turntable system

Dual water heaters for quick startup

Built-in tank drain

 See it on the BendPak / Ranger YouTube Page

Ranger® Shop Equipment

RWS-1B FEATURES:

Bubble Balancer

- Rugged die-cast aluminum head cone
- Easy to use self-leveling stand
- Built-in weight-storage compartments
- Self-aligning, spring-loaded cone
- Hardened cast pivot seat
- Recessed circular level bubble

RWS-1B Bubble Wheel Balancer

#5156100



Hub Hole Diameter - 1.5" - 4.5"
Calibrated at - 90°- 180°- 270°- 360°
Width - 12" / Height - 23"

RWS-3TC FEATURES:

Manual Tire Changer

- Heavy steel construction for maximum durability
- Efficient operation at a fraction of the cost
- Performs both mounting and bead breaking operations

RWS-3TC Manual Tire Changer

#5150400



Tire Capacity - 8" - 7.5" x 16"
Wheel Plate Diameter - 7.5"
Base Dimensions - 15" x 18"

RST-1WS Features:

Rolling Work Seat

- Padded seat
- Swivel casters for easy maneuverability
- Relieves sore back muscles
- Work more efficiently
- Sturdy steel tubing construction
- Low profile design

RST-1WS Rolling Work Seat

#5150514



Steel Tubing - 1"
Swivel Casters - 2.5"
Relieves sore back muscles

Clip-On Steel Wheel Weights



0.25oz, 0.75oz, 1oz, 1.25oz, 1.5oz, 1.75oz,
2oz, 2.25oz, 2.5oz, 2.75oz, 3oz
Qty. - 25 ea.

NEW PRODUCTS COMING SOON

Bendpak 12AP-SRT Short Column Lift



The perfect low-ceiling two-post lift. This short-rise lift is perfect for shops that primarily deal with changing tires. As part of the AP Series, you'll still enjoy triple-telescoping arms, Bi-Metric swing arms, and a 12,000-lb. lifting capacity.

Ranger RPX80E Tire Changer



Vertical
Carriage-Slide

Ranger LS45DS Sonar- Spot Wheel Balancer



Sonar-Spot
Technology

Rover Pressure Washer



2500 PSI

RST-500ES FEATURES:

- Adjusts to fit all vehicles
- Rubber foot pads to hold load securely
- Straddles inner fender wells
- Precisely positions engine for easy gear box and transmission removal
- Perfect for 4 and 6 cylinder engines
- Folds upright to conserve space

RES-1TF Features

- Heavy steel construction
- Long rubber-grip handle
- Head swivels 360° for easy positioning
- Heavy-duty swivel casters
- Slotted adjustable saddle permits quick and easy installation
- Neck is reinforced for extra strength

RSC-2TF FEATURES:

- Designed for shops with limited space
- Folds for easy storage
- Heavy-duty steel casters
- Neck is reinforced for extra strength
- Wide base for maximum stability
- Telescoping boom provides 4 positions
- Heavy steel construction

RST-500ES Engine Support

#5150103



Holding Capacity - 1,500 lbs.
Screw Travel - 13"
Adjustable Width - 40" - 63"

RES-1TF Engine Stand

#5150470



Holding Capacity - 2,000 lbs.
Front Width - 31" / Rear Width - 27.5"
Height - 37.5" / Length - 41"

RSC-2TF Folding Shop Crane

#5150105



Boom Length - 40" - 63"
Boom Capacity - 1,100 - 4,400 lbs.
Boom Height - 80" - 93"

RIC-4716 Inflation Cage

#5150315



Max Tire Width - 16"
Max Tire Diameter - 47"
Solid-steel welded-steel base

A/C Recovery Machine

#5150025



Refrigerant: R134a
Car, truck, SUV and bus compatibility
Tank Capacity - 50 lbs.

AC-134A

A/C Pressure adjustment

Electric database

Flushing function for rapid discharge of used coolant

R134a Refrigerant

Meets UL 1963 & SAE J2788 Standards

Automatic oil discharge



CoolCharge

Shop Equipment

ergochair™



ERGO-RS

#5215988



Wall Mounted Hangers
AVAILABLE

FEATURES

- 350-Pounds Rated Capacity
- Shock-Absorbing & Quiet Rolling Wheels
- Heavy-Duty Non-Slip Textured Marine-Grade Vinyl
- Comfortable Thick Padded Seat and Backrest
- Heavy-duty Ball-Bearing TPR Swivel Casters
- No Assembly Required
- Multiple Locking Heights
- Powder Coated Welded-Steel Tubular Frame



ERGO-SCOOT

#5160118



Four Adjustable
Positions

FEATURES

- Thermoplastic rubber wheels that are resistant to chemicals, acids, alcohol, and water
- Wide, large diameter wheels ease travel over rough surfaces.
- Heavy-duty non-slip textured marine-grade vinyl
- Comfortable thick, padded seat and backrest
- Heavy-duty ball-bearing TPR swivel casters
- Spring loaded backrest
- Four seat height positions
- Gas spring height adjustment
- Locking pins adjust seat height from 14 to 18-inches off the ground.
- Rated to 350-pounds maximum capacity.



*Shown with adjustable
risers installed



ELEVATE COMFORT, ENHANCE PRODUCTIVITY

ERGO-JET

#5160112



FEATURES

- Thermoplastic rubber wheels are resistant to chemicals, acids, alcohol, and water
- Wide, large diameter wheels improves rolling over rough surfaces
- The comfortable thick padded seat and backrest are constructed of heavy duty non-slip marine grade vinyl.
- Horizontal and vertical arm adjustment
- Adjustable footrests for more leverage
- Locking casters
- Adjustable air spring for multiple positions
- Rated to 350-pounds maximum capacity



ERGO-GLIDE

#5160120



FEATURES

- TPR Wheels Feature A Shock Absorbing Cushioned Ride, While Providing Good Floor Protection And Quiet Rolling Operation
- TPR Wheels Are Resistant To Chemicals, Acids, Alcohol, And Water
- Wide, Large Diameter Wheel Improves Rolling Over Rough Surfaces
- Heavy-Duty Non-Slip Textured Marine Grade Vinyl
- Comfortable Thick-Padded Seat And Backrest
- Locking Casters
- 3 Locking Positions
- Seat Is Resistant To Abrasion, Chemical, And Oil



Evaporative Air Coolers



COOLBREEZE SERIES

CB-12SL Portable Evaporative Air Cooler

#5150018

OPTIONAL
208-230V
Model
CB-12SLH
#5150017



CB-14SL Portable Evaporative Air Cooler

#5150030

OPTIONAL
208-230V
Model
CB-14SLH
#5150031



CB-26SL Portable Evaporative Air Cooler

#5150018

OPTIONAL
208-230V
Model
CB-26SLH
#5150037



Fan Diameter - 12"
Water Capacity - 15 Gal
Max. Airflow - 1,565 CFM

Fan Diameter - 14"
Water Capacity - 15.6 Gal
Max. Airflow - 2,300 CFM

Fan Diameter - 26"
Water Capacity - 50 Gal
Max. Airflow - 6,027 CFM

Water Drip System

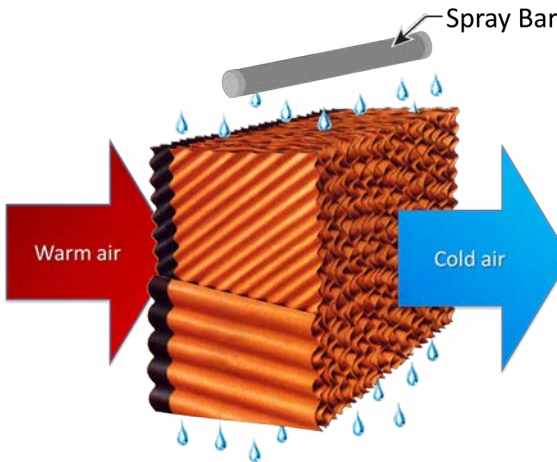

Cool Boss Protective Cover

Small - #5326303
Medium - #5326304
Large - #5326305



Small Fits - CB-16
Medium Fits - CB-28
Large Fits - CB-36

COOLBREEZE SERIES FEATURES:

- Oscillating swing-louvers
- Blue Flex™ axial flow fan
- User-friendly controls
- Three-speed fan
- Water inlet flow control
- Standard power supply - 110V / 60 Hz / 1 Ph
- Honeycool™ evaporative media
- Durable swivel casters
- Constant water inlet
- Protective cover comes standard
- Space-saving design
- Extra-long power cord
- GFCI plug
- UL® Certified

SWING-LOUVERS

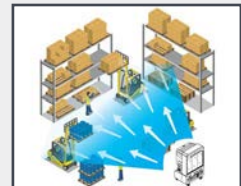

COOLBLAST SERIES

CB-16L Portable Evaporative Air Cooler

#5150151

OPTIONAL
208-230V
Model
CB-16H
#5150176



OPTIONAL ACCESSORY
CB-16 Duct Kit
5150236

Fan Diameter - 16"
Water Capacity - 60 Gal
Max. Airflow - 4,950 CFM

CB-28L Portable Evaporative Air Cooler

#5150152

OPTIONAL
208-230V
Model
CB-28H
#5150177



Fan Diameter - 28"
Water Capacity - 80 Gal
Max. Airflow - 9,020 CFM

CB-36L Portable Evaporative Air Cooler

#5150153

OPTIONAL
208-230V
Model
CB-36H
#5150178



Fan Diameter - 36"
Water Capacity - 115 Gal
Max. Airflow - 12,615 CFM

CoolBoss CB-28HV 80-Gallon High-Velocity Fan

#5150179



HIGH
VELOCITY
17,820
CFM

NEW!



Fan Diameter - 28"
Tank - 80-Gallon
Cooling Capacity - 3,915 sq. ft.



COOLBLAST SERIES FEATURES:

- Remote control with a convenient holder
- Automatic water source shutoff
- Water inlet flow control
- Durable ABS plastic shell construction
- Variable-speed fan
- Standard power supply - 110V / 60 Hz / 1 Ph
- Honeycool™ evaporative media
- Bluetooth® audio player
- Built-in speakers
- LED floodlight
- Space-saving design
- Soft-touch LED controls
- Antibacterial housing
- Durable swivel casters
- 360° handle
- Protective cover comes standard
- Built-in timer
- Extra-long power cord
- GFCI plug
- UL® Certified

HVLS Industrial Ceiling Fans

SUPERIOR DESIGN NEXT LEVEL PERFORMANCE

- 
Durable Construction
- 
Energy Efficient
- 
Low Noise Levels
- 
Enhance Productivity
- 
Permanent Magnet Motor



Cool Boss HVLS fans generate industry-leading performance with maximum airflow while maintaining the lowest energy consumption possible. Apart from energy efficiency and cost savings benefits, every Cool Boss fan provides instant area comfort more efficiently and effectively than any other air movement solution. Our fans deliver a huge volume of air at any speed, so you'll rarely need to run them at max capacity, which is one of the many advantages and benefits of HVLS technology.

TEMPEST SERIES

CB-11HVLS

#5150201



11.5 ft. DIAMETER

Fan Diameter - 11.5 ft. (3.5m)
 Weight - 152 lb. (69kg)
 Air Volume - 4,200 (m³/min)

CB-16HVLS

#5150202



16 ft. DIAMETER

Fan Diameter - 16.4 ft. (5.0m)
 Weight - 176 lb. (80kg)
 Air Volume - 10,200 (m³/min)

WINDSTORM SERIES

CB-20HVLS

#5150203



20 ft. DIAMETER

Fan Diameter - 20 ft. (6.1m)
 Weight - 282 lb. (128kg)
 Air Volume - 12,700 (m³/min)

CB-24HVLS

#5150237

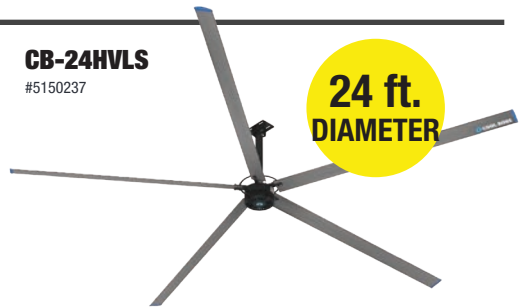

24 ft. DIAMETER

Fan Diameter - 24 ft. (7.3m)
 Weight - 295 lb. (134kg)
 Air Volume - 14,850 (m³/min)

Coolee Portable Air Coolers

coolee™

BY COOL BOSS®

CL-240

#5150019 • #5150033

3-IN-1

- PORTABLE AIR COOLER
- 14-QUART ICE-CHEST
- BLUETOOTH SPEAKERS

SPECS:

- Capacity: 14-Quarts
- Rechargeable 10,000mAh lithium-ion battery
- Battery charge lasts up to 4 hrs on low, 3.5 hrs. on high
- Interior Dimensions: 9 (H) x 12 (W) x 7 (D) in.
- Exterior Dimensions: 18.5 (H) x 13 (W) x 12 (D) in.
- Dry weight with battery pack: 15.5 lbs.



coolee™

BY COOL BOSS®

CL-50R

#5150078



4-IN-1

- PORTABLE AIR COOLER
- 50-QUART ICE-CHEST
- BLUETOOTH™ SPEAKERS
- PORTABLE POWER BANK

MODEL CL-50R:

- Capacity: 50-Quarts
- Dual rechargeable 10,000mAh lithium-ion batteries
- Battery charge lasts up to 6 hrs. on low, 4 hrs. on high
- Int. Dimensions: 21.25 (L) x 12.5 (W) x 12 (H) in.
- Ext. Dimensions: 23 (L) x 14.25 (W) x 16.25 (H) in.
- Dry weight with battery packs: 32 lbs.



Recirculated Cooling



Powerful Dual-Fans



Eco-Friendly Solar Panels



USB Output



Power Supply

Manufacturing Superiority

Medium and Heavy-Duty Products

BendPak recognizes the manufacturing process as our moment of maximum influence. When we ship a piece of equipment, we need to know that the product leaving our manufacturing complex is the best it could be. That's why we demand nothing short of the very finest in facilities and machinery. Our primary factory houses development and manufacturing for medium and heavy-duty lifting products and wheel service models. At just over 300,000 square ft., it's designed for maximum efficiency and safety. Plus, we consistently employ the best steel fabrication techniques in the world.

Main Production Facility

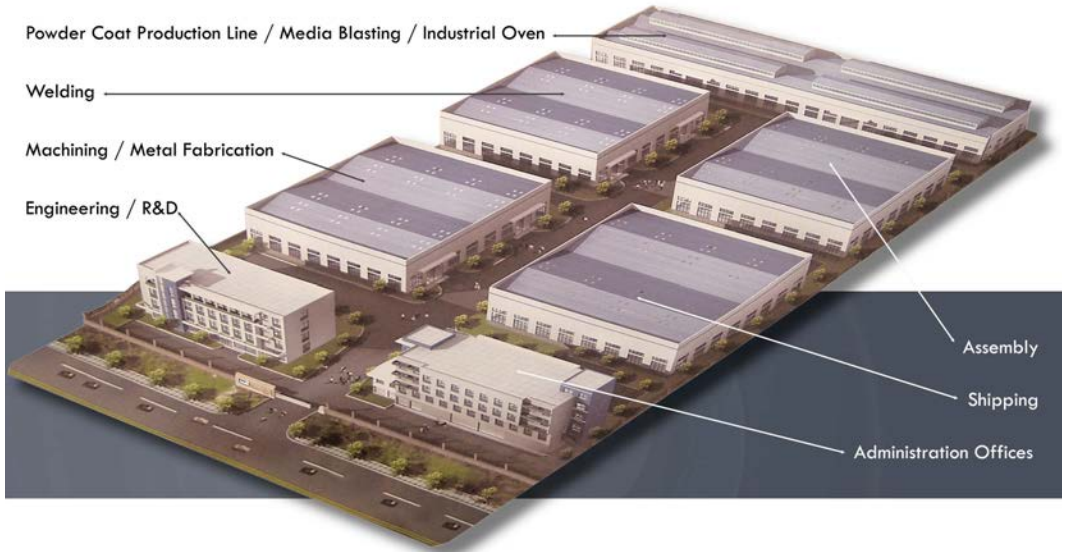

Light and Medium-Duty Products

BendPak's second mega-sized manufacturing facility is used primarily for the fabrication of light and medium-duty lift products, select parking systems and vehicle repair tools and equipment. The multiplex factory houses state-of-the-art equipment including, numerically-controlled turning and milling equipment and automated welding systems. Full-capability services like comprehensive metallurgy testing, heat treatment, automated powder coating and other specialty operations take place here as well. The facility also houses assembly and packaging operation centers and product development testing labs for BendPak's growing customer base around the globe.

**BendPak**

New Alabama Facility Speeds up Shipping



BendPak recently announced the opening of a new 100,000 square-foot distribution center near Mobile, Alabama, to better serve customers in the eastern United States. The administrative and shipping complex, which is expected to be fully operational within 60 days, is located in Theodore, just a short drive from the expanding Port of Mobile. The new facility has easy access to three major interstates and five Class I railroads, helping BendPak to deliver products same-day or next-day to more customers in the eastern half of the country.

New Dynamic And Energizing Work Environment



BendPak expanded again with the purchase of a 22,256-square-foot administrative building which serves as our brand-new global headquarters. This dynamic and energizing work environment offers BendPak employees stunning views and a serene atmosphere which will ultimately inspire creativity and foster productivity. Our new headquarters features many zen-like elements including a waterfall, babbling brook, and a peaceful koi pond to name a few. Whenever we need a change of pace to stimulate new ideas, we can also take advantage of the many outdoor relaxation and meeting spaces.

Safe Practices are Best Practices

Our multi-department manufacturing complexes have allowed us to expand both machinery and employees to triple our daily production capacity. All BendPak employees are Q.C. trained and follow rigid ISO-9001 guidelines. Every day, more than 700 employees around the world dedicate themselves to putting our core values into action. Safety is first—it's our company's top priority, followed closely by environmental responsibility, cost-efficiency, quality, customer service and accountability for all departments. These principles guide our highly skilled workforce toward BendPak's unified vision.

Including new acquisitions like our latest facility in Mobile, Alabama, BendPak's facilities encompass over 700,000 sq. ft. worldwide. Each location follows strict guidelines as outlined by ISO-9001, further supporting our position as a premier global manufacturer. At BendPak, we ensure that our offshore manufacturing is no different in approach or standards from our domestic production. These facilities are audited year-round and undergo systematic evaluation of documented quality programs such as TUV, ANSI/ALI ALCTV, CSA, UL and AS/NZS 1418.9. The programs are also audited quarterly to ensure continued compliance with all applicable standards.



AMERICA'STM FAVORITE

SINCE 1965



BendPak[®]

Ranger[®] AUTOSTACKER[™] MAXJAX[®]
COOL BOSS[™] QUICKJACK[™] JACKPAK[®]

30440 Agoura Road • Agoura Hills, CA 91301 USA

Tel: 1-800-253-2363 • www.bendpak.com

© 2024 BendPak Inc. All rights reserved.

PN 5900401